

# VistaCam iX HD Smart



EN Installation and operating instructions



2109100026L02 2210V003

The current version of the installation and operating instructions is available in the Download Center:



<http://qr.duerdental.com/2109100026>

# Contents



## Important information

<b>1 About this document</b> . . . . .	3
1.1 Warnings and symbols . . . . .	3
1.2 Copyright information . . . . .	4
<b>2 Safety</b> . . . . .	4
2.1 Intended purpose . . . . .	4
2.2 Indications . . . . .	4
2.3 Contraindications . . . . .	5
2.4 Intended use . . . . .	5
2.5 Improper use . . . . .	5
2.6 General safety information . . . . .	5
2.7 Combining devices safely . . . . .	5
2.8 Specialist personnel . . . . .	5
2.9 Electrical safety . . . . .	6
2.10 Essential performance characteristics . . . . .	6
2.11 Notification requirement of serious incidents . . . . .	6
2.12 Only use original parts . . . . .	6
2.13 Transport . . . . .	6
2.14 Disposal . . . . .	6



## Product description

<b>3 Overview</b> . . . . .	8
3.1 Scope of delivery . . . . .	8
3.2 Accessories . . . . .	9
3.3 Optional items . . . . .	9
3.4 Consumables . . . . .	9
3.5 Wear parts and replacement parts . . . . .	9
<b>4 Technical data</b> . . . . .	10
4.1 Handpiece . . . . .	10
4.2 Cam interchangeable head . . . . .	11
4.3 Proof interchangeable head . . . . .	11
4.4 Proxi interchangeable head . . . . .	11
4.5 Handpiece holder with USB hub (optional) . . . . .	12
4.6 Ambient conditions . . . . .	13

4.7 Type plate . . . . .	14
4.8 Evaluation of conformity . . . . .	14

<b>5 Operation</b> . . . . .	15
5.1 Cam interchangeable head . . . . .	16
5.2 Proof interchangeable head . . . . .	16
5.3 Proxi interchangeable head . . . . .	18
5.4 Handpiece holder . . . . .	19
5.5 Handpiece holder with USB hub (optional) . . . . .	19
5.6 Storage box . . . . .	19



## Assembly

<b>6 Installation</b> . . . . .	20
6.1 Installing the handpiece holder . . . . .	20
<b>7 Commissioning</b> . . . . .	20
7.1 Connecting the unit . . . . .	20
7.2 System requirements . . . . .	20
7.3 Configuring the unit in VistaSoft . . . . .	21
7.4 Configuring the appliance in DBSWIN . . . . .	21
7.5 Configuring the device in VistaSoft Connect . . . . .	21
7.6 Configure the appliance in Vista-Config for VistaEasy . . . . .	22
7.7 Connect the handpiece holder with the USB hub (optional) . . . . .	23
7.8 Acceptance tests . . . . .	23
7.9 Handover record . . . . .	23



## Usage

<b>8 Operation</b> . . . . .	24
8.1 Changing the interchangeable head . . . . .	24
8.2 Use of hygienic protective covers . . . . .	25
8.3 Place on the spacer . . . . .	25
8.4 Record an image with the Cam interchangeable head . . . . .	26

- 8.5 Record an image with the Proof interchangeable head . . . . . 26
- 8.6 Record an image with Proxi interchangeable head . . . . . 28
- 8.7 Switching off the camera . . . . . 30
- 9 Reprocessing of the device . . . . . 31**
  - 9.1 Risk analysis and categorisation . 31
  - 9.2 Preparation process in accordance with ISO 17664 . . . . . 31
  - 9.3 Preparation at the operating location . . . . . 32
  - 9.4 Manual cleaning, disinfection and drying . . . . . 32
- 10 Reprocessing the spacer . . . . . 33**
  - 10.1 Risk analysis and categorisation . 33
  - 10.2 Preparation process in accordance with ISO 17664 . . . . . 33
  - 10.3 Preparation at the operating location . . . . . 35
  - 10.4 Manual cleaning, intermediate rinsing, disinfection, final rinse, drying . . . . . 36
  - 10.5 Automatic cleaning, intermediate rinsing, disinfection, final rinse, drying . . . . . 36
  - 10.6 Check for function . . . . . 36
  - 10.7 Steam sterilising . . . . . 37
  - 10.8 Issue clearance for the parts for sterilisation . . . . . 37
  - 10.9 Storing parts for sterilisation . . . 37
- 11 Cleaning . . . . . 38**
  - 11.1 Cleaning the optical element . . . 38
  - 11.2 Storage box . . . . . 38
- 12 Maintenance . . . . . 39**
  - 12.1 Replace the O-ring . . . . . 39
  - 12.2 Firmware update . . . . . 39



**Appendix**

- 14 Handover record . . . . . 43**
- 15 Country representatives . . . . . 45**



**Troubleshooting**

- 13 Tips for operators and service technicians . . . . . 40**
  - 13.1 Proof interchangeable head . . . . 41
  - 13.2 Proxi interchangeable head . . . . 41

# Important information

## 1 About this document

These installation and operating instructions represent part of the unit.



If the instructions and information in these installation and operating instructions are not followed, Dürr Dental will not be able to offer any warranty or assume any liability for the safe operation and the safe functioning of the unit.

The German version of the installation and operating instructions is the original manual. All other languages are translation of the original manual. These operating instructions apply to VistaCam iX HD Smart:

- VistaCam iX HD Smart Handpiece: 2109120050
- VistaCam iX HD Smart Industry Handpiece: 2109120051
- VistaCam iX HD Smart Industry2 Handpiece: 2109120052
- VistaCam iX HD Smart Ultradent Handpiece: 2109120055
- VistaCam iX HD Smart Hygiene Cover (20 pcs): 2109010051
- VistaCam iX HD Smart Hygiene Cover (100 pcs): 2109010052
- VistaCam iX HD Smart Hygiene Cover (500 pcs): 2109010050
- Cam Interchangeable Head: 2109130060
- Proof Interchangeable Head: 2109130061
- Proxi Interchangeable Head: 2109130062

### 1.1 Warnings and symbols

#### Warnings

The warnings in this document are intended to draw your attention to possible injury to persons or damage to machinery.

The following warning symbols are used:



General warning symbol

The warnings are structured as follows:



#### SIGNAL WORD

##### Description of the type and source of danger

Here you will find the possible consequences of ignoring the warning

- Follow these measures to avoid the danger.

The signal word differentiates between four levels of danger:

- **DANGER**  
Immediate danger of severe injury or death
- **WARNING**  
Possible danger of severe injury or death
- **CAUTION**  
Risk of minor injuries
- **NOTICE**  
Risk of extensive material/property damage

#### Other symbols

These symbols are used in the document and on or in the unit:



Note, e.g. specific instructions regarding efficient and cost-effective use of the unit.



Refer to Operating Instructions.



Wear protective gloves.



Wear protective goggles.



Use a mask.



Use protective clothing.



Manufacturer



Date of manufacture



CE labelling



Conformity mark for the United Kingdom of Great Britain and Northern Ireland



Ukrainian conformity mark

CH REP

Authorised representative for Switzerland



Type BF application part



Refer to the accompanying electronic documents.



Dispose of correctly in accordance with EU Directive 2012/19/EU (WEEE).



Do not reuse

SN

Serial number

REF

Order number

HIBC

Health Industry Bar Code (HIBC)

MD

Medical device

## 1.2 Copyright information

All circuits, processes, names, software programs and units mentioned in this document are protected by copyright.

The Installation and Operating Instructions must not be copied or reprinted, neither in full nor in part, without written authorisation from Dürr Dental.

## 2 Safety

Dürr Dental has designed and constructed this unit so that when used properly and for the intended purpose it does not pose any danger to people or property.

Despite this, the following residual risks can remain:

- Personal injury due to incorrect use/misuse
- Personal injury due to mechanical effects
- Personal injury due to electric shock
- Personal injury due to radiation
- Personal injury due to fire
- Personal injury due to thermal effects on skin
- Personal injury due to lack of hygiene, e.g. infection

### 2.1 Intended purpose

The intraoral camera generates an optical image of the oral cavity or face of the patient.

#### VistaCam iX HD Smart Cam

The intraoral camera with Cam interchangeable head is used in or next to the oral cavity of the patient. The images aid with diagnosis, provide information for the patient and are used for instruction.

#### VistaCam iX HD Smart Proof

The intraoral camera with interchangeable head Proof is intended for the detection and diagnosis of caries.

#### VistaCam iX HD Smart Proxi

The intraoral camera with Proxi interchangeable head enables the detection of approximal caries based on the translucence of healthy tooth enamel to light waves in the infrared range.

### 2.2 Indications

#### VistaCam iX HD Smart Cam

The images support diagnosis, patient communication and patient instruction and are used for instruction and documentation purposes.

#### VistaCam iX HD Smart Proof

The intraoral camera with Spectra interchangeable head is designed for the detection and diagnosis of caries.

## VistaCam iX HD Smart Proxi

The intraoral camera with Proxi interchangeable head is a diagnostic aid for detection of approximal caries above the gingiva and for monitoring of the progress of this type of lesions.

## 2.3 Contraindications

### VistaCam iX HD Smart Cam

None.

### VistaCam iX HD Smart Proof

Large-scale tooth restorations can falsify the displayed caries value.

### VistaCam iX HD Smart Proxi

The Proxi head is not designed for use on artificial teeth, on teeth bearing crowns and on teeth with excessively large fillings. The device functions only in the context of natural enamel in the mouth of the patient. After extraction, teeth can no longer be analysed with the Proxi head.

## 2.4 Intended use

The camera handpiece can be used in combination with a variety of interchangeable heads. This enables different applications in healthcare facilities, dental practices, dental clinics, orthodontic surgery, and oral and maxillofacial surgery. With the aid of a computer, monitor and imaging software, this digital system can be used to create and store images and videos. The following accessories must always be used: a spacer (not for the Cam interchangeable head) and hygienic protective covers.

## 2.5 Improper use

Any use of this appliance / these appliances above and beyond that described in the Installation and Operating Instructions is deemed to be incorrect usage. The manufacturer cannot be held liable for any damage resulting from incorrect usage. The operator will be held liable and bears all risks.

Do not operate the device in any rooms in containing flammable mixtures, e.g. in operating theatres.

Do not use the camera directly on the eye.

## 2.6 General safety information

- › Always comply with the specifications of all guidelines, laws, and other rules and regulations applicable at the site of operation for the operation of this unit.
- › Check the function and condition of the unit prior to every use.
- › Do not convert or modify the unit.
- › Comply with the specifications of the Installation and Operating Instructions.
- › The Installation and Operating Instructions must be accessible to all operators of the unit at all times.

## 2.7 Combining devices safely

Take care when connecting units together or to parts of other systems as there is always an element of risk (e.g. due to leakage currents).

- › Only connect units when there can be no question of danger to operator or to patient.
- › Only connect units when it is safe to do so and when there is no risk of damage or harm to the surroundings.
- › If it is not 100% clear from the unit data sheet that such connections can be safely made or if you are in any doubt, always get a suitably qualified person (e.g. the manufacturer) to verify that the setup is safe.
- › Observe the specifications of IEC 60601-1 (EN 60601-1) when connecting the appliance with other appliances, e.g. a PC system, both in and outside the patient environment.
- › Only connect peripheral units (e.g. computer, monitor, printer) that conform at least to the requirements set out in IEC 60950-1 (EN 60950-1).

## 2.8 Specialist personnel

### Operation

Operating personnel are dentists and dental personnel.

They must ensure safe and appropriate handling on the basis of their training and know-how.

- › Instruct or have every user instructed in handling the unit.

### Installation and repairs

- › Installation, readjustments, alterations, upgrades and repairs must be carried out by Dürr Dental or by qualified personnel specifically approved and authorized by Dürr Dental.

## 2.9 Electrical safety

- › Comply with all the relevant electrical safety regulations when working on the unit.
- › Never touch the patient and open connectors/ contacts of the appliance at the same time.
- › Replace any damaged cables or plugs immediately.

### Observe the EMC rules concerning medical devices

- › Electro-magnetic interference or ESD impulses can cause image artefacts in the images or unit malfunction. Restart the appliance, the software or the computer if necessary.
- › The unit is intended for use in professional healthcare facilities (in accordance with IEC 60601-1-2). If the appliance is operated in another environment, potential effects on electromagnetic compatibility must be taken into account.
- › Do not operate the unit in the vicinity of HF surgical instruments or MRT equipment.
- › Maintain a minimum distance of at least 30 cm between the unit and other electronic devices.
- › Keep a minimum distance of 30 cm between the unit and mobile radio devices.
- › Note that cable lengths and cable extensions have effects on electromagnetic compatibility.

The following accessories can have an effect on the electromagnetic compatibility:

Handpiece holder with USB hub . . . 2109105051



#### NOTICE

##### Negative effects on the EMC due to non-authorized accessories

- › Use only Dürr Dental parts or accessories specifically approved by Dürr Dental.
- › Using any other accessories may result in increased electromagnetic interference emissions or the unit having reduced electromagnetic immunity, leading to an erroneous operation mode.

## 2.10 Essential performance characteristics

The unit does not have any essential performance characteristics as set out in IEC 60601-1 section 4.3.

## 2.11 Notification requirement of serious incidents

The operator/patient is required to report any serious incident that occurs in connection with the device to the manufacturer and to the competent authority of the Member State in which the operator and/or patient is established/resident.

## 2.12 Only use original parts

- › Only use accessories and optional items that have been recommended or specifically approved by Dürr Dental.
- › Only use only original wear parts and replacement parts.



Dürr Dental accepts no liability for damages or injury resulting from the use of non-approved accessories or optional accessories, or from the use of non-original wear parts or replacement parts. The use of non-approved accessories, optional accessories or non-genuine wear parts / replacement parts (e.g. mains cables) can have a negative effect in terms of electrical safety and EMC.

## 2.13 Transport

The original packaging provides optimum protection for the unit during transport.

If required, original packaging for the unit can be ordered from Dürr Dental.



Dürr Dental will not accept any responsibility or liability for damage occurring during transport due to the use of incorrect packaging, even where the unit is still under guarantee.

- › Only transport the unit in its original packaging.
- › Keep the packing materials out of the reach of children.

## 2.14 Disposal

### Unit



The unit must be disposed of properly. Within the European Union, the unit must be disposed of in accordance with EU Directive 2012/19/EU (WEEE).



- › If you have any questions about the correct disposal of parts, please contact your dental trade supplier.



An overview of the waste keys for Dürr Dental products can be found in the download area:



<http://qr.duerrdental.com/P007100155>

## Product description

### 3 Overview

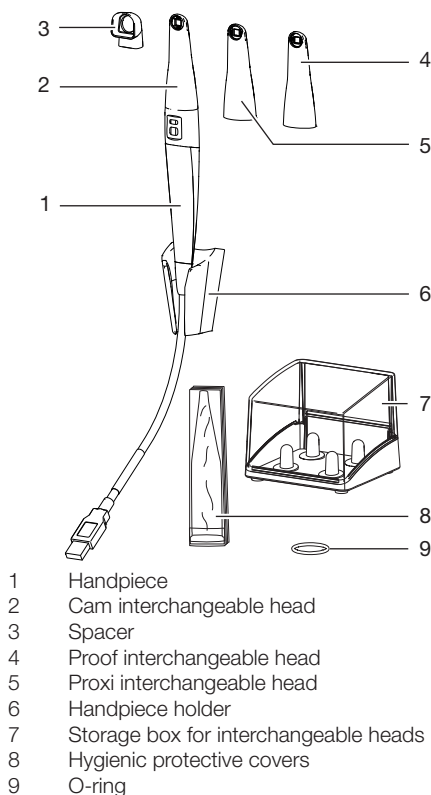

### 3.1 Scope of delivery

The following items are included in the scope of delivery (possible variations due to country-specific requirements and/or import regulations):

#### **VistaCam iX HD Smart with Cam, Proof and Proxi package . . . . . 2109100001**

- Handpiece
- Cam interchangeable head
- Proof interchangeable head
- Proxi interchangeable head
- Storage box for interchangeable heads
- Handpiece holder
- Hygienic protective covers (qty. 20)
- Spacers (2 x 5 pieces)
- O-ring, 17 x 1.5 mm (2 pieces)
- Microfibre cloth
- Voucher for VistaSoft imaging software
- Short information

#### **VistaCam iX HD Smart with Cam and Proof package . . . . . 2109100002**

- Handpiece
- Cam interchangeable head
- Proof interchangeable head
- Storage box for interchangeable heads
- Handpiece holder
- Hygienic protective covers (qty. 20)
- Spacers (5 pieces)
- O-ring, 17 x 1.5 mm (2 pieces)
- Microfibre cloth
- Voucher for VistaSoft imaging software
- Short information

#### **VistaCam iX HD Smart with Cam and Proxi package . . . . . 2109100003**

- Handpiece
- Cam interchangeable head
- Proxi interchangeable head
- Storage box for interchangeable heads
- Handpiece holder
- Hygienic protective covers (qty. 20)
- Spacers (5 pieces)
- O-ring, 17 x 1.5 mm (2 pieces)
- Microfibre cloth
- Voucher for VistaSoft imaging software
- Short information

#### **VistaCam iX HD Smart with Cam package . . . . . 2109100004**

- Handpiece
- Cam interchangeable head
- Storage box for interchangeable heads
- Handpiece holder
- Hygienic protective covers (qty. 20)
- O-ring, 17 x 1.5 mm (2 pieces)
- Microfibre cloth
- Voucher for VistaSoft imaging software
- Short information

### 3.2 Accessories

The following items are required for operation of the device, depending on the application:

- Cam interchangeable head for VistaCam iX HD Smart . . . . . 2109130050
- Proof interchangeable head for VistaCam iX HD Smart . . . . . 2109130051
- Proxi interchangeable head for VistaCam iX HD Smart . . . . . 2109130052
- Handpiece holder for VistaCam iX HD Smart . . . . . 2109105050
- Storage box for VistaCam iX HD Smart interchangeable heads . . . . . 2109135050

VistaCam iX HD Smart hygienic protective covers (500x) . . . . . 2109010050

VistaCam iX HD Smart hygienic protective covers (100x) . . . . . 2109010052

Spacers for VistaCam iX HD Smart (5x) . . . . . 2109132050

### 3.3 Optional items

The following optional articles can be used with the unit:

Handpiece holder with USB hub . . . 2109105051

### 3.4 Consumables

The following materials are consumed during operation of the device and must be ordered separately:

VistaCam iX HD Smart hygienic protective covers (500x) . . . . . 2109010050

VistaCam iX HD Smart hygienic protective covers (100x) . . . . . 2109010052

Spacers for VistaCam iX HD Smart (5x) . . . . . 2109132050

- FD multi wipes compact
- Surface disinfection . . . . . CDF33FW0150
- FD 333 forte wipes
- Quick-acting disinfection . . . . . CDF33FW0150
- FD 322 premium wipes
- Quick-acting disinfection . . . . . CDF322A0140
- ID 215 Enzymatic instrument cleaner . . . . . CDI215A6150
- ID 213
- Instrument disinfection . . . . . CDI213C6150
- Reinigungs-Set für VistaCam Optik .2109025050

### 3.5 Wear parts and replacement parts

The following working parts need to be changed at regular intervals (refer to the "Maintenance" section):

O-ring, 17 x 1.5 mm (2 pieces) . . . 2109124050



Information about replacement parts is available from the portal for authorised specialist dealers at: [www.duerrdental.net](http://www.duerrdental.net)

## 4 Technical data

### 4.1 Handpiece

Electrical data		
Rated voltage	V DC	5
Communication interfaces		USB 2. 0
Type of protection		IP20
Protection class		II
Operating mode*		T1/T2 = 27% 1.5 min / 5.5 min (switch-on/switch-off time)

\* At an ambient temperature of max. 40 °C and while observing the switch-on/off time, the hand-piece/the interchangeable head reaches a maximum surface temperature of 60 °C.

Classification	
Medical Device Class (MDR)	I

Electromagnetic compatibility (EMC) Interference emission measurements	
High-frequency emissions in accordance with CISPR 11	Group 1 Class B
Harmonics in acc. with IEC 61000-3-2	Not applicable
Voltage fluctuations/flickers in acc. with IEC 61000-3-3	Not applicable

Electromagnetic compatibility (EMC) Interference immunity tests	
Static electricity discharge in accordance with IEC 61000-4-2	Compliant
Magnetic field for a supply frequency (50/60 Hz) in accordance with IEC 61000-4-8	Compliant
Emitted HF disturbance variables in accordance with IEC 61000-4-3	Compliant

Camera electronics		
Image sensor		1/3" CMOS
Number of image points sensor	MPixel	1.37
Max. pixels effective (PC)		1280 x 1024
Video codec		Motion JPG
Brightness control		Automatic
White balance		Fixed

**Dimensions and weights****Handpiece with Cam interchangeable head**

Length	mm	200
Diameter	mm	24
Weight with cable	g	190
Weight without cable	g	70
Cable length	cm	250

**4.2 Cam interchangeable head****Technical data**

Light source		2 LEDs, white light
Wavelength	nm	400 - 780
Irradiance	W/m <sup>2</sup>	0.8
Sharpness level	mm	4 - ∞
Focus level, preset	mm	17
Opening angle		64°
Applied part		Type BF

**4.3 Proof interchangeable head****Proof interchangeable head**

Light source		2 LEDs
Wavelength	nm	380 - 460
Dominant wavelength	nm	405
Irradiance	W/m <sup>2</sup>	0.5
Sharpness level	mm	4 - ∞
Focus level, preset	mm	8
Opening angle		64°
Applied part		Type BF

**4.4 Proxi interchangeable head****Proxi interchangeable head**

Light source		2 LEDs
Wavelength	nm	780 - 880
Dominant wavelength	nm	850
Irradiance	W/m <sup>2</sup>	0.34
Sharpness level	mm	4 - ∞
Focus level, preset	mm	8
Opening angle		64°

### Proxi interchangeable head

Applied part

Type BF

## 4.5 Handpiece holder with USB hub (optional)

### Electrical data

Nominal voltage	V DC	12
-----------------	------	----

### General technical data

Dimensions (W x H x D)	mm	58 x 83 x 123
------------------------	----	---------------

Weight	g	190
--------	---	-----

### Power supply type

Manufacturer	GlobTek Inc.
--------------	--------------

Model	GTM41076-0612-X.X
-------	-------------------

### Electrical data – power supply unit

Rated voltage	V AC	100 - 240
---------------	------	-----------

Mains frequency	Hz	47 - 63
-----------------	----	---------

Max. nominal current	A	0.5
----------------------	---	-----

Output voltage	V DC	12
----------------	------	----

Max. output voltage fluctuations	%	±1
----------------------------------	---	----

Output current	A	0.5
----------------	---	-----

Rated power	W	6
-------------	---	---

### Connection cable

Cable length	cm	250
--------------	----	-----

### Electromagnetic compatibility (EMC) Interference emission measurements

High-frequency emissions in accordance with CISPR 11	Group 1 Class B
--	--------------------

Harmonics in acc. with IEC 61000-3-2	Not applicable
--------------------------------------	----------------

Voltage fluctuations/flickers in acc. with IEC 61000-3-3	Compliant
--	-----------

### Electromagnetic compatibility (EMC) Interference immunity tests

Static electricity discharge in accordance with IEC 61000-4-2	Compliant
---	-----------

Electrical fast transient/burst immunity test in accordance with IEC 61000-4-4	Compliant
--	-----------

Voltage surge in accordance with IEC 61000-4-5	Compliant
--	-----------

**Electromagnetic compatibility (EMC)****Interference immunity tests**

Voltage dips, short interruptions and voltage variations in accordance with IEC 61000-4-11	Compliant
Magnetic field for a supply frequency (50/60 Hz) in accordance with IEC 61000-4-8	Compliant
Emitted HF disturbance variables in accordance with IEC 61000-4-3	Compliant

**4.6 Ambient conditions****Ambient conditions during operation**

Temperature	°C	10 to 40
Relative humidity	%	20 to max. 75
Air pressure	hPa	700 - 1060

**Ambient conditions during storage and transport**

Temperature	°C	-15 to +60
Relative humidity	%	max. 90
Air pressure	hPa	700 - 1060

## 4.7 Type plate

The type plate is located on the cable:

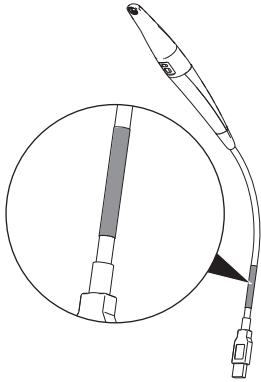

## 4.8 Evaluation of conformity

This device has been subjected to conformity acceptance testing in accordance with the current relevant European Union guidelines. This equipment conforms to all relevant requirements.



## 5 Operation

The intraoral camera consists of a handpiece and various interchangeable heads. The function of the camera depends on the function of the interchangeable head. The interchangeable head is recognisable from the symbol on the rear.

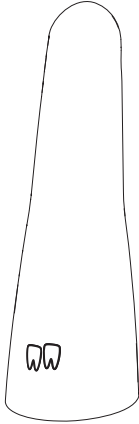

Cam interchangeable head



Proof interchangeable head



Proxi interchangeable head

Intraoral images

Intraoral images for the detection of caries, plaque and calculus

Intraoral images for the detection of caries in the approximal region

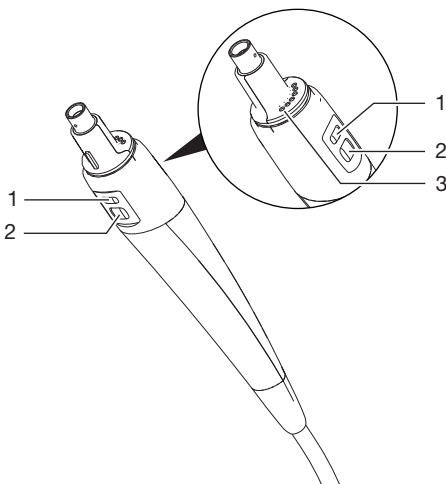

- 1 Focus button
- 2 Trigger button
- 3 Contacts for interchangeable head

The interchangeable head is plugged onto the handpiece and connected via the contacts. A guide prevents incorrect placement of the interchangeable head.

There are two buttons on each side of the handpiece: the focus button and trigger button. The pressure point of the buttons is noticeable.

The focus button is used to focus the camera sharply on the object. The focal plane is preset on the spacer during placement of the Proof or Proxi interchangeable head, but can be changed with the focus button.

Still images and video recordings can be created with the camera. The function of the trigger button is dependent of the recording mode in the imaging software (still image or video). In the Still Image mode, the camera switches between Live mode (moving image) and Freeze mode (still image). In Video mode, the recording starts or stops. Pressing the trigger button causes the camera to vibrate slightly. Optionally, a foot switch can also be used for triggering.

The illumination is incorporated in the interchangeable head. The optical element is divided: One part is in the handpiece, the other part is in the interchangeable head.

The image sensor in the handpiece digitises the image. The camera transmits the image to a computer via the USB connection cable.

The connection cable is used to connect the camera directly to the USB connection of the computer or, optionally, to the handpiece holder with USB hub.

Imaging software from Dürr Dental is required for the camera.

The power supply of the camera to the computer is realised via the USB connection cable.

The camera switches off automatically if it is not moved for one minute. As soon as the camera is moved, it switches on again.

## 5.1 Cam interchangeable head

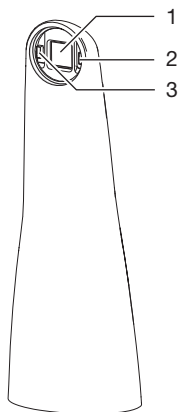

- 1 Optical system
- 2 LED
- 3 LED

The Cam interchangeable head has an optical element with autofocus with a focal range for intraoral recordings. When placing on the interchangeable head, the focus level is preset to two molars. Two LEDs are positioned around the optical element for even illumination.



Fig. 1: Recording with Cam interchangeable head

## 5.2 Proof interchangeable head

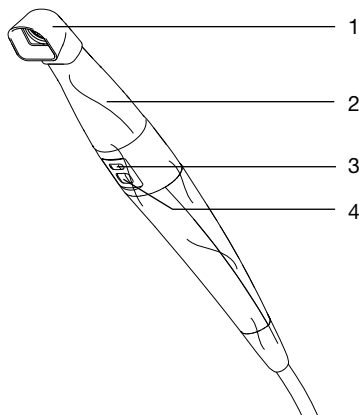

- 1 Spacer
- 2 Interchangeable head
- 3 Focus button
- 4 Trigger button

The Proof interchangeable head is used to create intraoral images for the detection of caries, plaque and calculus.





Two LEDs are positioned around the optical element with blue/violet light (wavelength 405 nm). The energy-rich light causes the tooth structure (enamel, dentine) and the metabolites cariogenic bacteria (porphyrins) to fluoresce. The substances emit different colours. This makes it possible to analyse caries activity and detect potential tooth disease.

Substance	Fluorescent colour
Tooth structure (enamel, dentine)	Green
Metabolites of cariogenic bacteria (porphyrins)	Red

The spacer enables optimum analysable images. The position and the distance of the image are reproducible. In addition, the spacer screens off the image area and minimises the penetration of external light.

Application areas of the Proof interchangeable head:

- Detecting plaque and calculus
- Detecting caries at an early stage
  - Fissure caries that are difficult to detect
  - Precise location of carious lesions on smooth surfaces
  - Optically-supported check during excavation
- Checking, documenting and archiving the progress of dental illnesses in the imaging software.

	Healthy tooth enamel
1.0	
	Initial caries, early stages of enamel caries
1.5	
	Enamel caries up to the enamel/dentine junction
2.0	
	Dentine junction already exceeded
2.5	
	Deep dentine caries

### Evaluation

The images are analysed by the imaging software with the help of a filter.

The prophylaxis view shows the original image.

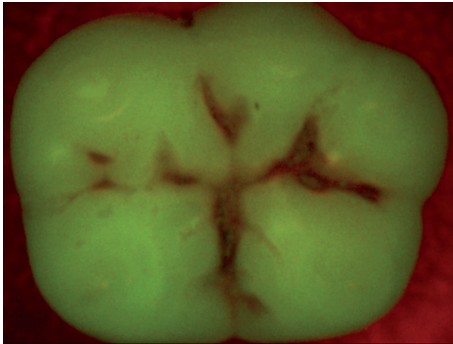

*Fig. 2: Prophylaxis view*

The caries view analyses the fluorescence of the substances with the caries filter.

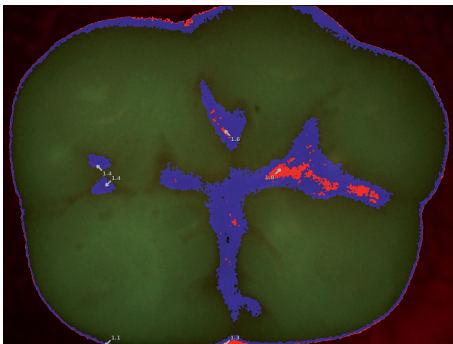

*Fig. 3: Caries view*

The colour scale and the numeric values provide reliable information on carious lesions:

### 5.3 Proxi interchangeable head

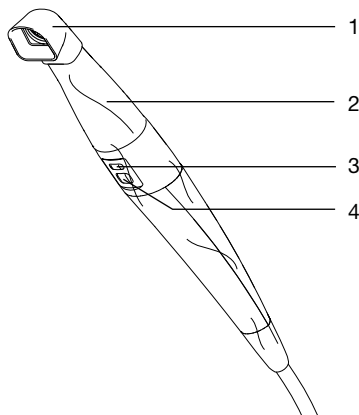

- 1 Spacer
- 2 interchangeable head
- 3 Focus button
- 4 Trigger button

The handpiece with the Proxi interchangeable head creates a black and white image for detecting caries in the approximal region.

The optical element is placed on the row of teeth. An image is created by actuating the trigger button. The spacer facilitates the placement of the optical element on the row of teeth. In addition, the spacer screens off the image area and minimises the penetration of external light.

Two powerful infra-red LEDs are installed in the optical system. The infra-red light illuminates the tooth and is reflected with varying intensity depending on the translucency (light transmission) of the dental structures. The reflected light is recorded by the optical element and is analysed as a black and white image in the VistaSoft imaging software.

#### Evaluation

The black and white image shows structures with varying translucency as different levels of brightness. The lower the translucency, the higher the reflection of the infra-red light and the brighter the structure. It is possible to make out the following structures:

- Healthy enamel appears very dark, high translucency
- Approximal caries appears bright, low translucency
- Dentine appears bright, low translucency
- Several restorations appears bright, no translucency

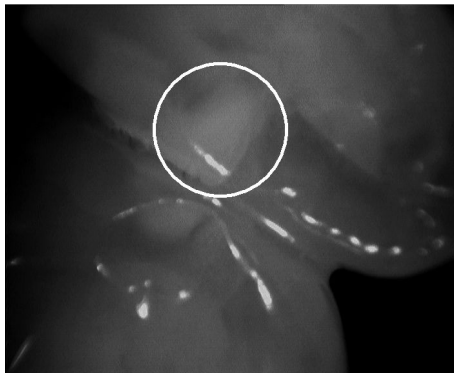

*Fig. 4: Case example 1 – Lesions in the mesial area are visible as a wide bright strip up to the enamel/dentine boundary.*



*Fig. 5: Case example 2 – Enamel lesions can be seen as wedge-shaped structures within the dark translucent tooth enamel. The lesions reach to the inner half of the enamel.*

The system cannot distinguish between structures with the same amount of translucency. Thus it is not suitable for the diagnosis of:

- Secondary caries under restorations
- Dentine caries
- Central occlusal caries

The enamel appears brighter in patients with highly opaque enamel. The caries diagnosis is complicated here by the low difference in contrast.

## 5.4 Handpiece holder



The camera is automatically switched off when placed in the handpiece holder. The camera switches on automatically when taken out.

## 5.5 Handpiece holder with USB hub (optional)

The camera can also be connected to the computer via the handpiece holder with USB hub. This enables a greater distance between the camera and computer.

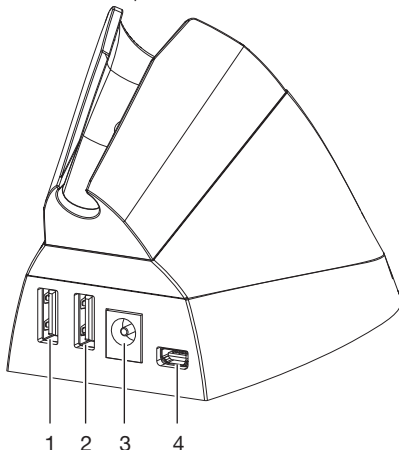

1 USB connection (for camera or USB stick)

- 2 USB connection (for camera or USB stick)
- 3 Connection for power supply unit
- 4 Micro USB connection for computer

The camera is connected to the handpiece holder. An additional USB connection is available, e.g. to connect a USB stick.

The camera switches off automatically when placed in the handpiece holder. The camera switches on automatically when taken out.

## 5.6 Storage box

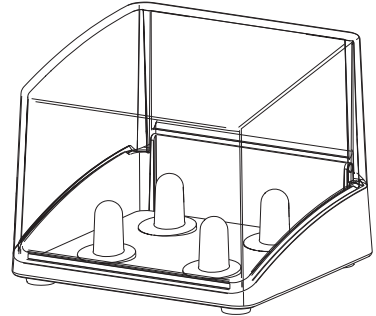

The storage box protects the interchangeable heads not placed on the camera from soiling and scratches. It can store up to four interchangeable heads.

## Assembly

### 6 Installation

#### 6.1 Installing the handpiece holder

The handpiece holder can be glued or screwed.

- › Choose suitable fastening material.
- › Install the handpiece holder close to the handpiece.

The USB cable is 2.5 m long.

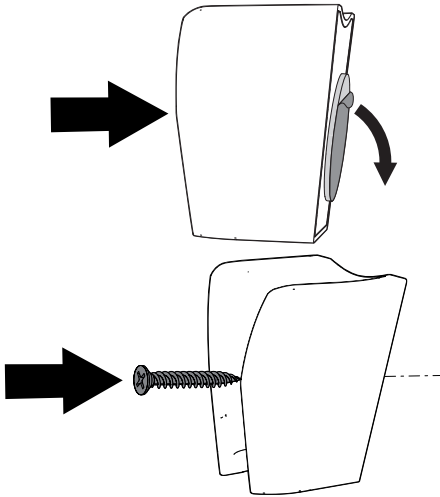

### 7 Commissioning



#### NOTICE

**Short circuit due to the build up of condensation**

- › The unit can only be put into operation once it has warmed up to room temperature and is dry.

The unit supports the following imaging programs:

- VistaSoft from Dürr Dental
- VistaConnect from Dürr Dental
- DBSWIN from Dürr Dental
- VistaEasy from Dürr Dental
- ImageBridge from Dürr Dental
- Third-party software on request

#### 7.1 Connecting the unit

The camera can be used directly after connection. The installation of a device driver is not necessary.



The unit has no main power switch. Ensure that the USB connection on the computer and, if necessary, the handpiece holder with USB hub are easily accessible and that the unit can be unplugged if necessary.

- › Connect the USB connection cable to a computer USB connection socket.
- › If the USB cable is to be extended, use an USB repeater (order number 2106-155-63) or handpiece holder with USB hub (2109-105-51).

#### 7.2 System requirements



The system requirements for the computer systems can be found in the download area at [www.duerrdental.com](http://www.duerrdental.com) (document no. 9000-618-148).

Proper operation of the Dürr Dental hardware and software is coordinated.

- › Based on the *system requirements for computer systems*, check whether the device is compatible with the installed hardware/software.

### 7.3 Configuring the unit in Vista-Soft

The camera is preconfigured in the imaging software and can be used directly.

The following unit settings can be made in the configuration of the imaging software:

#### Standby settings

Standby time      Time until automatic switch-off if the camera is not moved.  
Preset: 2 minutes

#### Acquisition settings

Camera triggering      The time at which the focus and the image acquisition are executed when pressing the focus button or the trigger button:  
– Upon pressing (preset)  
– Upon releasing

- ›  *Geräte > VistaCam iX HD > Konfigurieren > Geräteeinstellungen* wählen.
- › Einstellungen ändern.



### 7.4 Configuring the appliance in DBSWIN

- › Start DBSWIN.
- › In the *Options menu*, select *> Display Configuration*.  
The *Configuration* registration card opens.
- › Click on the *Modules*  button.
- › Double click on *Video*.  
The *Video Properties* window opens.
- › Select the registration card *Video source 1*.
- › Working under *Control type*, select the camera connected.

The following settings can be made:

#### Video source

- |                       |  |
|-----------------------|--|
| WDM driver            | The WDM driver is selected automatically.  |
| Noise reduction       | If noise reduction is active, the set number of images are captured one after the other for each imaging operation. The system uses these images to generate a new image that eliminates interference to the greatest possible extent. |
| Capture ring Function | <ul style="list-style-type: none"> <li>– <i>Trigger the function during release</i></li> <li>– Trigger the function when pressing (pre-set)</li> </ul>   |

#### Settings

- |              |  |
|--------------|--|
| Image export | Each image is automatically copied to a defined path. The path, file format and other settings are set in the <i>Light Table</i> module. |
|--------------|--|

### 7.5 Configuring the device in VistaSoft Connect

The configuration is set up in the settings of the imaging software.

- › Start the imaging software.
- › Click *Settings*.
- › Click *Device list*.
- › Check that the tick is placed in the column *Connected*.  
This shows that the unit is connected to the imaging software and that it has been detected.

- › Set a tick next to *Use in VistaSoft Connect*.
- ›  > *Geräte > VistaCam iX HD > Konfigurieren > Geräteeinstellungen* wählen.
- › Einstellungen ändern.

## 7.6 Configure the appliance in VistaConfig for VistaEasy

- › Start VistaConfig via *Start > All Programs > Duerr Dental > VistaConfig > VistaCamConfig*.

The camera is detected and activated automatically.

The registration card *Settings* opens.

The following settings can be made:

### Display

Resolution      The resolution of the camera image can be selected

Interlaced      Full screen view (preset)

### WDM driver

Driver            The WDM driver "VistaCam iX HD" is selected automatically.



### Capture ring

Function          The function of the capture ring can be selected.

*Record + Pause* is preset.

Trigger event    Time at which the image is created if the trigger button is pressed:

- Upon pressing (preset)
- On releasing

- › To change the configuration, click .
- › To save the configuration, click on .



## 7.7 Connect the handpiece holder with the USB hub (optional)

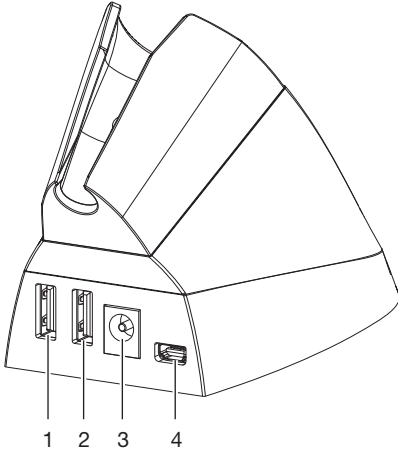

- 1 USB connection (for camera or USB stick)
- 2 USB connection (for camera or USB stick)
- 3 Connection for power supply unit
- 4 USB connection for computer

Requirements:

- ✓ Mains voltage must match the information shown on the type plate of the power supply unit
- › Connect the power unit to the connection socket on the handpiece holder.
- › Plug the mains plug into the power outlet.
- › Connect the handpiece holder with the USB cable with the computer.
- › Connect the connection cable of the camera in the USB connection of the handpiece holder.

## 7.8 Acceptance tests

### Electrical safety checks

- › Perform the electrical safety check according to national law.
- › Document the results.



The interchangeable heads in the various versions (see "5 Operation") are application parts in accordance with IEC 60601-1.

## 7.9 Handover record

- › Carry out and document the instruction and handover for the unit.



A sample handover report is included in the attachment.

## 8 Operation



### NOTICE

#### Damage to the camera from falling down or scratching

- › Always place the camera in the hand-piece holder.
- › Do not place the camera on a storage shelf.
- › Do not place the camera between other treatment instruments.

### 8.1 Changing the interchangeable head

The function of the camera depends on the interchangeable head. The following interchangeable heads are available:



Cam interchangeable head



Proof interchangeable head



Proxi interchangeable head

#### Remove the interchangeable head

- › Pull the interchangeable head off the hand-piece upwards.

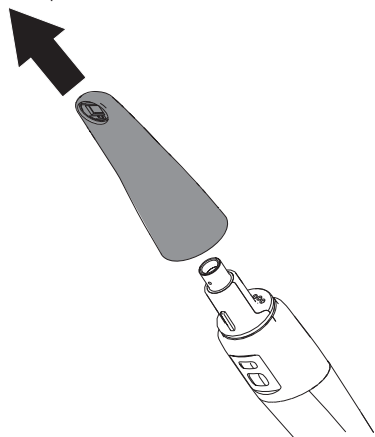

#### Place on the interchangeable head

Requirements:

- ✓ The handpiece and interchangeable head are completely dry.
- › Slide the interchangeable head onto the hand-piece (rotate if necessary) until it engages. A guide on the handpiece ensures that the interchangeable head is placed on correctly.

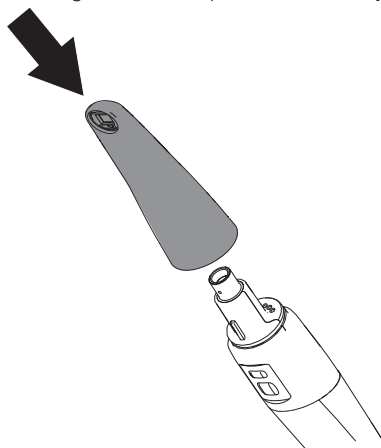

## 8.2 Use of hygienic protective covers



### WARNING

**Danger of cross contamination when not using the hygienic protective cover or when using the hygienic protective cover more than once**

- › Do not use the unit without the hygienic protective cover.
- › Do not use the hygienic protective cover more than once (disposable item).



Do not use the hygienic protective cover more than once (disposable item).



Wear protective gloves when applying the hygienic protective cover.

- › Hold the camera so that the optical element faces down.
- › Lift the white edge of the hygienic protective cover and slide the camera head into the cover. The transparent plastic side must face upwards.

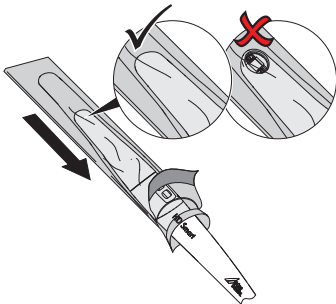

- › Stretch the hygienic protective cover an extra 2 - 3 mm so that the cover presses tightly against the optical element.
- › Carefully press the hygienic protective cover against the optical window using your fingertips. Ensure that there are no air bubbles between the optical window and the disposable hygienic protective cover.

- › Hold the hygienic protective cover firmly on the white edge and pull off the transparent plastic side in the direction of the camera head.

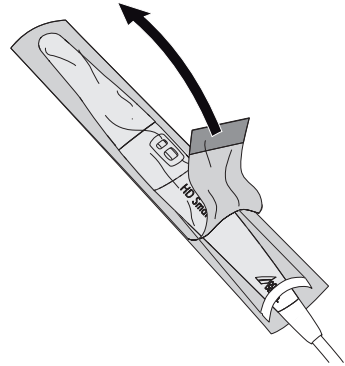

- › Pull off the paper underside from the camera head in the direction of the handpiece.

## 8.3 Place on the spacer

The spacer is required for imaging with the Proof and Proxi interchangeable heads.



### WARNING

**Danger of cross-contamination when used without reprocessing or following incorrect reprocessing**

- › Sterilise the spacer in the steam steriliser (see "10 Reprocessing the spacer") before each use.
- › Place the spacer onto the interchangeable head from above. Ensure that the spacer does not cover the optical element of the interchangeable head.

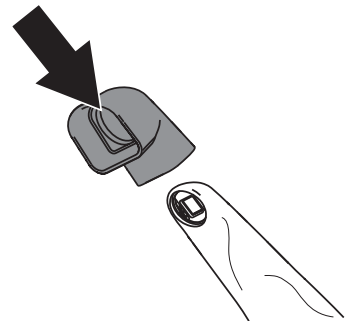

## 8.4 Record an image with the Cam interchangeable head

Still images and video can be recorded with the camera. The possible recording modes are dependent on the imaging software.

Requirements:

- ✓ Camera connected with the computer
- ✓ Imaging software started
- › Take the camera out of the handpiece holder. A moving image can be seen (Live mode) in the recording window of the imaging software.
- › Select the desired recording mode (still image or video) in the imaging software.
- › Select the image section.
- › Press one of the two focus buttons.

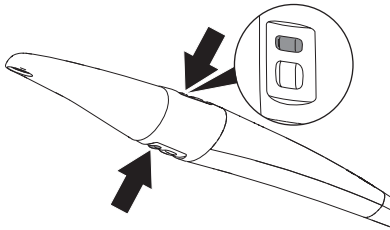

The camera focuses.

- › Press one of the two trigger buttons.

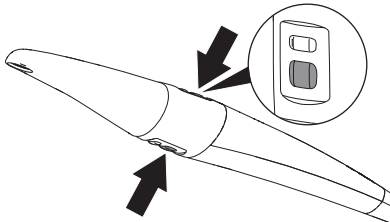

The camera switches to Freeze mode or video recording starts. The still image/video is transferred to the imaging software.

- › To switch back to Live mode or to stop video recording, press the trigger button again.
- › Edit and save the image/video in the imaging software. (For further information, see the software help.)

## 8.5 Record an image with the Proof interchangeable head

Bei Aufnahmen mit dem Wechselkopf Proof sind in der Imaging-Software zwei Ansichten möglich.



### Prophylaxe-Ansicht

Sie gibt einen anschaulichen Nachweis über den Status der Mundhygiene.



### Karies-Ansicht

Sie wertet die Fluoreszenz der Substanzen aus und gibt anhand der Farben einen zuverlässigen Hinweis auf kariöse Läsionen.

Folgende Faktoren können die Fluoreszenz und damit die Karies-Auswertung beeinflussen:

- Verschmutzungen und Speisereste
- Zahnstein, Konkremente
- Hilfsmittel zur Anfärbung von Plaque
- Prophylaxe-/Fluor-Pasten
- Zahn-/Polierpasten



### CAUTION

#### Health risks for the patient due to contraindications

- › Before taking an X-ray image, check the present tooth restorations.

- › See "2.3 Contraindications".

### Preparation

The teeth must be prepared differently depending on the required analysis.

#### For prophylaxis view:

- › Do **not** clean the teeth professionally.

#### For caries analysis:

- › Carry out professional teeth cleaning.
- › Remove polishing paste using the air/water spray.
- › Dry the teeth.

### Record an image



### CAUTION

#### The UV light of the camera can dazzle

- › Do not peer into the light source.
- › Do not use the camera directly on the eye.

## Requirements:

- ✓ Camera connected with the computer
- ✓ Imaging software started
- ✓ Camera in hygienic protective cover
- ✓ Spacer placed on
- › Reduce the penetration of external light. Turn off or dim sources of external light (e.g. operating lights).
- › Dry the row of teeth with compressed air.
- › Place the camera with spacer onto the corresponding tooth.

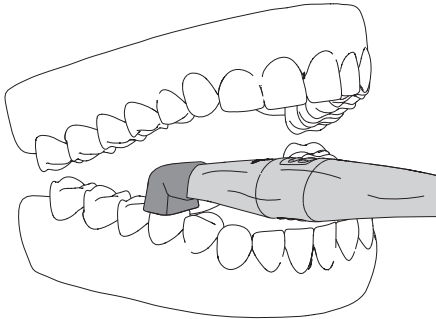

- › If the image is not sharp, press one of the two focus buttons.

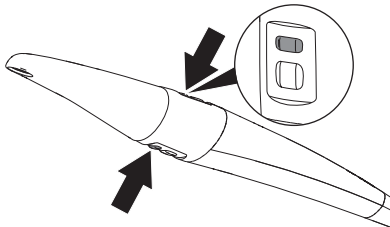

The camera focuses.

- › Press one of the two trigger buttons.

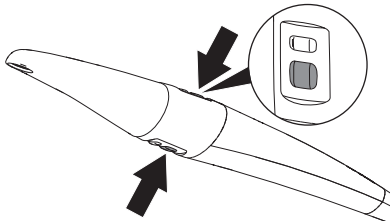

The camera switches to "Freeze" mode. The still image is transferred to the imaging software.

- › Edit the image in the imaging software and save. (For further information, refer to the software manual)
- › Analyse the image (see "Analyse the image").

- › To switch back to Live mode, press the trigger button again.

**Analyse the image**

The **prophylaxis view** shows the original image. Red areas indicate caries-causing bacteria. The healthy enamel is shown as green areas.

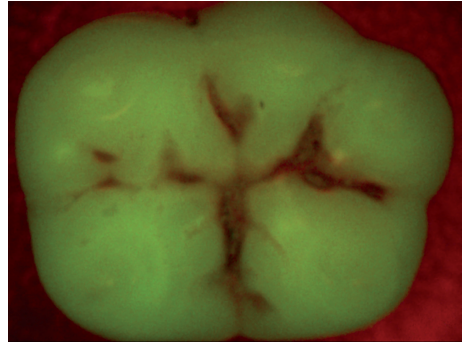

Fig. 6: Prophylaxis view

The **caries view** evaluates the fluorescence of the substances with the caries filter.

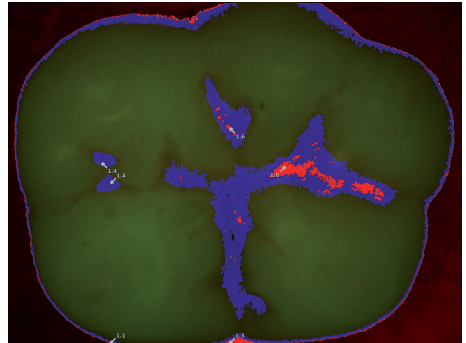





Fig. 7: Caries view

The colour scale and the numeric values provide reliable information on carious lesions:

-  Healthy tooth enamel  
1.0
-  Initial caries, early stages of enamel caries  
1.5
-  Enamel caries up to the enamel/dentine junction  
2.0

- Dentine junction already exceeded  
2.5
- Deep dentine caries

## 8.6 Record an image with Proxi interchangeable head



### CAUTION

**Health risks for the patient due to contraindications**

- › Before taking an X-ray image, check the present tooth restorations.

- › See "2.3 Contraindications".

### Positioning the camera correctly

The camera must be positioned correctly to achieve a good picture quality.

- › Position the camera in a line with the teeth.

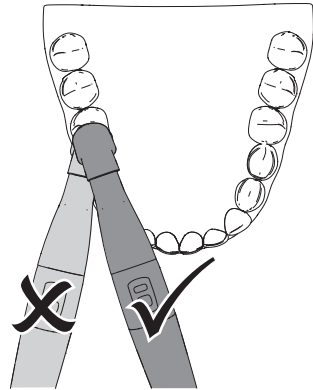

- › Place the spacer vertically on the tooth surface. The spacer must come into contact with the teeth.
- › Ensure that the relevant approximal area is located in the centre of the image section.
- › If the structure underneath the enamel is not visible, change the angle of the camera slightly.

### Record an image

Requirements:

- ✓ Camera connected with the computer
- ✓ Imaging software started
- ✓ Camera in hygienic protective cover
- ✓ Spacer placed on
- › Reduce the penetration of external light. Turn off or dim sources of external light (e.g. operating lights).
- › Dry the row of teeth with compressed air.

- › Place the camera with spacer on the row of teeth above the approximal area.

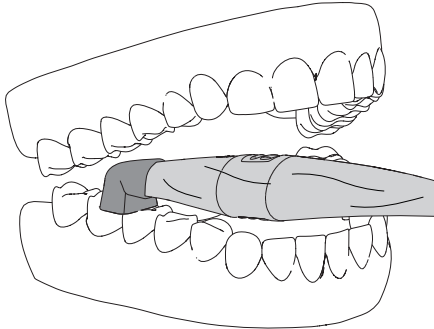

The infra-red LEDs illuminate the respective mesial and distal enamel area of the two adjacent teeth.

- › If the image is not sharp, press one of the two focus buttons.

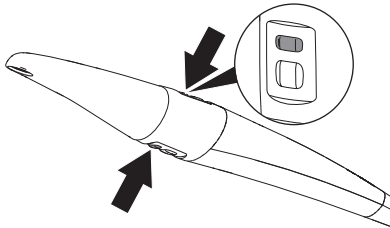

The camera focuses.

- › Press one of the two trigger buttons.

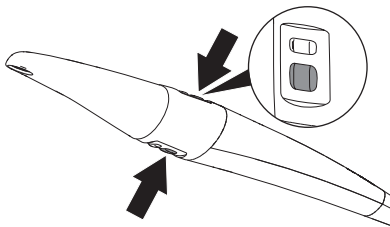

The camera switches to "Freeze" mode. The still image is transferred to the imaging software.

- › Edit the image in the imaging software and save. (For further information, refer to the software manual.)
- › Analyse the image (see "Analyse the image").
- › To return to Live mode, press the trigger button again.

### Analyse the image

The black and white image shows structures with varying translucency as different levels of brightness. The lower the translucency, the higher the reflection of the infra-red light and the brighter the structure. It is possible to make out the following structures:

- Healthy enamel appears very dark, high translucency
- Approximal caries appears bright, low translucency
- Dentine appears bright, low translucency
- Several restorations appear bright, no translucency

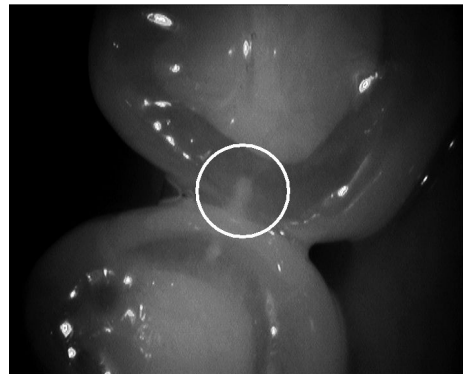

*Fig. 8: Enamel lesions can be seen as wedge-shaped structures within the dark translucent tooth enamel. The lesions reach to the inner half of the enamel.*

The enamel appears brighter in patients with highly opaque enamel. The caries diagnosis is complicated here by the low difference in contrast.

## 8.7 Switching off the camera

If the camera is not moved, it automatically switches itself off after the set stand-by time (pre-set 2 minutes).

Placing the camera in the handpiece holder, results in automatic switch-off.



Always store the camera with the interchangeable head plugged into the handpiece holder.



### WARNING

#### Danger due to re-use of products intended for single use

The disposable item is damaged after use and cannot be reused.

› Dispose of disposable items after use.

› Carefully pull off the hygienic protective cover and discard it.

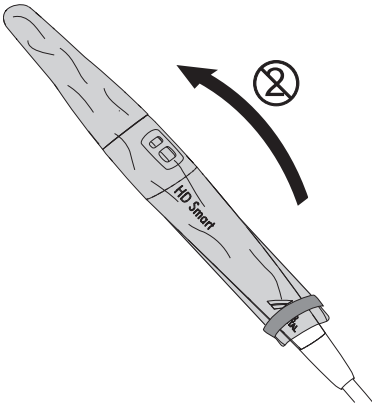

› Disinfect the camera (see "9 Reprocessing of the device").

› Place the camera in the handpiece holder.

#### **Result:**

The camera switches off automatically.



## 9 Reprocessing of the device

### 9.1 Risk analysis and categorisation

A risk analysis and categorisation of medical products often used in dentistry must be performed before their reprocessing by the operator. Comply with all national directives, standards and specifications such as e. g. the "Recommendations from the Commission for Hospital Hygiene and Infection Prevention".

Accessories of the medical device are also subject to reprocessing.

Classification recommendation based on proper use of the product: **Semi-critical A**

#### **Semi-critical medical product:**

A medical product which comes into contact with mucous membrane or pathologically affected skin.

The operator is responsible for correct classification of the medical products, defining the reprocessing steps and performing the reprocessing.

### 9.2 Preparation process in accordance with ISO 17664

Carry out the procedure for reprocessing after every treatment in accordance with the preparation process set out in ISO 17664.



#### **Important information!**

The reprocessing notes in accordance with ISO 17664 have been independently tested by Dürr Dental for the preparation of the device and its components for their reuse.

The person conducting the reprocessing is responsible for ensuring the reprocessing performed using the equipment, materials and personnel achieves the desired results. This requires validation and routine monitoring of the reprocessing process. Any deviation from the instructions described herein by the staff preparing the equipment could lead to lower effectiveness and possible negative consequences: these lie solely with the staff responsible.

Frequent reprocessing has little effect on the device components. The end of the product life cycle is especially influenced by the amount of wear and tear or damage resulting from its use.

The use of soiled, contaminated and damaged components is at the sole responsibility of the person performing the reprocessing and the operator.

The validation of the reprocessing method was performed based on the assumption that, in the worst case scenario, a disposable protective cover could be damaged while it is being pulled on or during use.

In accordance with IEC 80601-2-60, the application part of the intraoral camera is limited to a length of 80 mm, starting with the tip of the interchangeable head. During the validation of the reprocessing method, only the application part was looked at for this reason.

The reprocessing method was validated as follows:

- **Pre-cleaning**
  - FD multi wipes compact (Dürr Dental)
- **Manual cleaning**
  - FD 333 forte wipes (Dürr Dental)
- **Manual disinfection**
  - FD 333 forte wipes (Dürr Dental)

### General information

- › Comply with all national directives, standards and specifications for the cleaning, disinfection and sterilisation of medical products as well as the specific specifications for dental practices and clinics.
- › When selecting the cleaning and disinfectant agents to be used, the information provided (see "9.4 Manual cleaning, disinfection and drying") must be followed.
- › Comply with the concentration, temperature, residence time and post-rinsing specifications issued by the manufacturer of the cleaning and disinfectant agent.
- › Only use cleaning agents that are non-fixing and aldehyde-free and display material compatibility with the product.
- › Only use disinfectants that are aldehyde-free and display material compatibility with the product.
- › Only use freshly-produced solutions.
- › Only use distilled or deionised water with a low bacterial count (at least drinking water quality) that is free from facultatively pathogenic micro-organisms (e.g. legionella bacteria).
- › Use clean, dry, oil and particle-free compressed air.

### 9.3 Preparation at the operating location



Wear protective gloves.



Wear protective goggles.



Use a mask.



Use protective clothing.

- › Clean the hygienic protective cover (with integrated camera) with a disinfection wipe.
- › Carefully pull off the hygienic protective cover and discard it.
- › Clean the device with a disposable wipe soaked in cold tap water until no more dirt or contamination can be seen.

- › Protect the unit from contamination when transporting it from the treatment chair to the reprocessing location.

### 9.4 Manual cleaning, disinfection and drying



#### NOTICE

##### Damage to the device due to incorrect cleaning and disinfection

- › Only clean the surface of the unit.
- › Only use disinfection and cleaning agents specifically approved by Dürer Dental.
- › Do not use any aggressive or abrasive cleaning materials.
- › Only clean the unit using wipe disinfection.
- › Do not clean the unit by submerging or spraying in combination with disinfectant.
- › Do not steam sterilise the unit.

A combined cleaning and disinfectant agent is required for manual cleaning and disinfection. It must have the following properties:

- certified, possibly virucidal efficacy (DVG/RKI, VAH or European Standards)
- without chlorine, without solvent, no strong alkaline solutions (pH > 11), no strong oxidising agents

For further information, see: "General information".

#### Cleaning

- › Thoroughly wipe down the outer surfaces for 1 minute with a disinfection wipe.
- › Repeat this process with a new disinfection wipe.  
This means that the entire cleaning step is performed for 2 minutes.

#### Disinfection

- › Thoroughly wipe down the outer surfaces for 2 minutes with a disinfection wipe.
- › Repeat this process with a new disinfection wipe.  
This means that the entire disinfection step is performed for 4 minutes.

## Drying

- › Allow the device to air-dry.  
The device must be completely dry before a new hygienic protective cover is fitted.

## 10 Reprocessing the spacer

### 10.1 Risk analysis and categorisation

A risk analysis and categorisation of medical products often used in dentistry must be performed before their reprocessing by the operator. Comply with all national directives, standards and specifications such as e. g. the "Recommendations from the Commission for Hospital Hygiene and Infection Prevention".

Accessories of the medical device are also subject to reprocessing.

Classification recommendation given intended use of the product: **semi-critical B**

#### **Semi-critical medical product:**

A medical product which comes into contact with mucous membrane or pathologically affected skin.

The operator is responsible for correct classification of the medical products, defining the reprocessing steps and performing the reprocessing.

### 10.2 Preparation process in accordance with ISO 17664

Carry out the procedure for reprocessing after every treatment in accordance with the preparation process set out in ISO 17664.



### Important information!

The reprocessing notes in accordance with ISO 17664 have been independently tested by Dürr Dental for the preparation of the device and its components for their reuse.

The person conducting the reprocessing is responsible for ensuring the reprocessing performed using the equipment, materials and personnel achieves the desired results. This requires validation and routine monitoring of the reprocessing process. Any deviation from the instructions described herein by the staff preparing the equipment could lead to lower effectiveness and possible negative consequences: these lie solely with the staff responsible.

Frequent reprocessing has little effect on the device components. The end of the product life cycle is especially influenced by the amount of wear and tear or damage resulting from its use.

The use of soiled, contaminated and damaged components is at the sole responsibility of the person performing the reprocessing and the operator.

The reprocessing method was validated as follows:

- **Pre-cleaning**
  - FD 322 premium wipes for quick-acting disinfection (ready-to-use disinfection wipes, Dürr Dental)
- **Manual cleaning**
  - ID 215 enzymatic instrument cleaner (Dürr Dental)
  - Cleaning brush
- **Manual disinfection**
  - ID 213 instrument disinfection (Dürr Dental)
- **Automatic cleaning and disinfection**

Was performed in accordance with EN ISO 15883 with tested efficacy.

  - Cleaning agent: Neodisher MediClean Forte
  - RDG: G 7836 CD (Miele, Gütersloh)
  - Programs: "Cleaning without neutralisation" and "D-V-MEDFORTE"
- **Steam sterilisation**

was performed in accordance with EN ISO 17665 with the fractionated vacuum procedure.

  - Pre-vacuum: 3 x
  - Sterilisation temperature: 134 °C
  - Sterilisation time: 4 minutes
  - Drying time: min. 20 minutes
- **Cleaning brush**

Cleaning brush with nylon hairs, double-sided

  - Number of brush heads: 2
  - Brush material: nylon
  - Brush head length: 25 and 35 mm
  - Brush length: 5 and 10 mm

Example: Interlock cleaning brush, double-sided, green REF 09098

### General information

- › Comply with all national directives, standards and specifications for the cleaning, disinfection and sterilisation of medical products as well as the specific specifications for dental practices and clinics.
- › Comply with the specifications (see "10.4 Manual cleaning, intermediate rinsing, disinfection, final rinse, drying" and "10.5 Automatic cleaning, intermediate rinsing, disinfection, final rinse, drying") when selecting the cleaning and disinfectant agents to be used.

- › Comply with the concentration, temperature, residence time and post-rinsing specifications issued by the manufacturer of the cleaning and disinfectant agent.
- › Only use cleaning agents that are non-fixing and aldehyde-free and display material compatibility with the product.
- › Only use disinfectants that are aldehyde-free and display material compatibility with the product.
- › Do not use any rinse aid (danger of toxic residue on the components).
- › Only use freshly-produced solutions.
- › Only use distilled or deionised water with a low bacterial count (at least drinking water quality) that is free from facultatively pathogenic micro-organisms (e.g. legionella bacteria).
- › Use clean, dry, oil and particle-free compressed air.
- › Do not exceed temperatures of 138 °C.
- › Subject all devices used (ultrasonic bath, cleaning and disinfection device (CD), sealing device, steam steriliser) to regular maintenance and inspections.

### 10.3 Preparation at the operating location



Wear protective gloves.



Wear protective goggles.



Use a mask.



Use protective clothing.



#### **WARNING**

#### **Risk of infection from contaminated products**

Danger of cross contamination

- › Reprocess the product correctly and promptly before its first use and after every subsequent use.
- › Clean the spacer with a disposable wipe soaked in cold tap water until no more dirt or contamination can be seen.
- › Protect the unit from contamination when transporting it from the treatment chair to the reprocessing location.

## 10.4 Manual cleaning, intermediate rinsing, disinfection, final rinse, drying

A combined cleaning and disinfectant agent is required for manual cleaning and disinfection. It must have the following properties:

- certified, possibly virucidal efficacy (DWW/RKI, VAH or European Standards)
- without chlorine, without solvent, no strong alkaline solutions (pH > 11), no strong oxidising agents

For further information, see: "General information".

### Cleaning

- › Place the individual components in a disinfectant bath (non-fixing/aldehyde-free, see "General information") so that all parts are covered.
- › Comply with the reaction times of the cleaning agent and disinfectant (see "General information").
- › If you notice any further contamination, brush all exterior and interior surfaces completely with a hygienic brush under the surface of the ready-to-use solution.

### Intermediate rinsing

After the action time prescribed by the manufacturer:

- › Rinse off all components under water for at least 1 minute (temperature < 35°C).

### Disinfection

- › Place individual components in a cleaning and disinfectant bath so that all parts are covered.
- › Note the action time for the disinfectant.

### Final rinse

After the action time prescribed by the manufacturer:

- › Rinse off all components under water for at least 1 minute (temperature < 35°C).

### Drying

- › If necessary, re-dry at a clean location using a hygienic, lint-free cloth.
- › Blow dry the components with compressed air in a clean location.

## 10.5 Automatic cleaning, intermediate rinsing, disinfection, final rinse, drying

### Selection of the washer-disinfector

Automatic cleaning and disinfection requires a washer-disinfector with the following properties and validated processes:

- Corresponds to and tested in accordance with ISO 15883
- Certified program for thermal disinfection ( $A_0$  value  $\geq 3000$  or at least 5 minutes at 93°C)
- Programme is suitable for the components and provides sufficient rinsing cycles.  
For more information: "General information".

### Selection of the machine cleaning agents and disinfectants

The following properties are required:

- Material compatibility with the product
- Corresponds with the manufacturer's specifications of the CD

For further information, see: "General information".

### Automatic cleaning and disinfecting



When arranging the parts in the washer-disinfector, make sure there are no areas missed by rinsing.

- › Place components in the basket for small parts.

## 10.6 Check for function

- › After the end of the cleaning and disinfection cycle, check the components for any residual soiling and residual moisture. If necessary, repeat the cycle.
- › If necessary, replace any damaged parts.
- › The components should be packaged as soon as possible after drying and checking.

## 10.7 Steam sterilising

### Packing

For packaging of the components, use only sterile barrier systems made of transparent paper film that are approved for use in steam sterilisation according to the manufacturer information. This includes:

- Temperature resistance up to 138°C
- Standards EN ISO 11607-1/2
- The applicable sections of the standard series EN 868

The sterile barrier system must be large enough. Once it is loaded, the sterile barrier system must not be under any strain.

### Steam sterilising



#### WARNING

#### Health risk due to incorrect sterilisation

If the sterilisation not performed correctly, it may not be effective. The use of instruments that have not been properly sterilised can pose a health risk to the patient..

- › Only steam sterilisation must be used.
- › Comply with all of the specified process parameters.
- › Comply with the manufacturer's instructions regarding use of the steam steriliser.
- › Do not use any other methods.



#### NOTICE

#### Damage to equipment due to incorrect sterilisation

If the sterilisation process is not performed correctly, this can cause damage to the product.

- › Comply with the manufacturer's instructions regarding use of the steam steriliser.
- › Comply with all of the specified process parameters.

### Requirements placed on the steam steriliser:

- Corresponds to EN 13060 or EN 285 and/or ANSI AAMI ST79
- Suitable programme for the products listed (e. g. with hollow bodies, fractionated vacuum procedure in three vacuum steps)
- Sufficient product drying
- Validated process in accordance with ISO 17665 (valid IQ/OQ and product-specific performance appraisal (PQ))

Perform the following steps:

- › Sterilise the parts for sterilisation(at least 20 minutes at 121°C, at least 4 minutes at 270°F or at least 5 minutes at 134°C).



Do not exceed 138°C.

### Marking

- › Mark the packaged, treated medical product in such a way as to ensure safe application.

## 10.8 Issue clearance for the parts for sterilisation

The reprocessing of the medical products ends with the documented clearance for storage and renewed use.

- › Document the clearance of the medical product after reprocessing.

## 10.9 Storing parts for sterilisation

- › Comply with the stated storage conditions:
  - Store the parts protected against contamination
  - Dust-protected, e.g. in a locked cabinet
  - Protected against moisture
  - Protected against excessive temperature fluctuations
  - Protected against damage

Packaging for a sterile medical device can suffer damage as a result of a particular incident and the passage of time.

Potential external contamination of the sterile barrier system should be taken into account in terms of aseptic preparation when establishing the storage conditions.

## 11 Cleaning

### 11.1 Cleaning the optical element

The optical element is located partly in the interchangeable head and partly in the handpiece.



#### NOTICE

#### Damage of the optical element from incorrect cleaning

- › Only use the cleaning set for VistaCam optical element. Disinfectant residues soil the optical element.
- › Clean the window of the optical window of the interchangeable head from outside using the microfibre cloth with a drop of VistaCam optical element cleaner or alcohol.

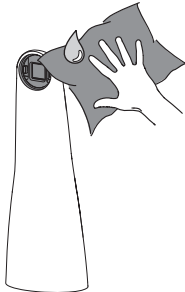

- › If particles can still be seen on the image, dry clean the interchangeable head from the inside with compressed air or with a foam rod (from the cleaning set).

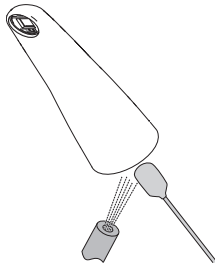

- › Dry clean the lens in the handpiece with compressed air or with a cotton bud (from the cleaning set).

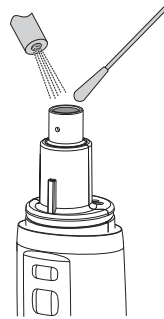

### 11.2 Storage box

Clean the surface of the storage box and the internal shelf in the event of contamination or visible soiling and disinfect.

Use the following cleaning materials for the storage box:

- ✓ FD 366 sensitive disinfectant for sensitive surfaces

Use the following cleaning materials for the shelf:

- ✓ FD 350 disinfectant wipes
- › Clean the surface of the storage box and the shelf with a dampened, soft, lint-free cloth.
- › Disinfect the storage box with spray disinfectant on a soft, lint-free cloth. Comply with the operating instructions for the disinfectant when doing this.
- › Disinfect the shelf using a disinfection wipe.



## 12 Maintenance

### 12.1 Replace the O-ring

If the interchangeable head does not engage properly when placed on, the O-ring on the handpiece can be replaced.

- › Replace the O-ring.



### 12.2 Firmware update



Do not break the connection between the unit and computer while updating the firmware.

- › Click on *Select firmware file*.

**Result:**

The firmware is updated. The process can take several minutes.

# ? Troubleshooting

## 13 Tips for operators and service technicians

 Any repairs exceeding routine maintenance may only be carried out by qualified personnel or our service.

Error	Possible cause	Remedy
<b>Image cloudy, milky</b>	Hygienic protective cover not placed correctly on the optical window	› Place the hygienic protective cover on the optical window correctly.
	Hygienic protective cover pulled on the wrong way round: do not place the transparent side on the optical window	› Pull on the hygienic protective cover correctly (see "8.2 Use of hygienic protective covers").
	Optical window soiled	› Clean the optical window (see "11.1 Cleaning the optical element").
	Optical element scratched	› Replace the interchangeable head.
	Handpiece defective	› Send the handpiece for repair.
<b>Image too dark</b>	LEDs defective	› Replace the interchangeable head.
<b>No image</b>	USB connection cable not connected	› Connect the USB connection cable.
	USB connection cable incorrectly lengthened	› Use the USB repeater or handpiece holder with USB hub to lengthen the connection cable, see "3.3 Optional items".
	Computer not switched on, software not started	› Switch on the computer and start the software.
	Camera driver not correctly installed	› Check the driver installation and software settings.
	Interchangeable head not placed on correctly, no contact between the handpiece and the interchangeable head	› Ensure that the interchangeable head has been placed on to its fullest extent, no gap between the handpiece and the interchangeable head
		› Grease the o-ring with a little Vaseline, replace if necessary (see "12.1 Replace the O-ring")
<b>The interchangeable head does not lock</b>	Defective O-ring on the handpiece	› Replace the O-ring.

Error	Possible cause	Remedy
Moving image judders	Insufficient computing power	<ul style="list-style-type: none"> <li>› Reduce the image resolution.</li> <li>› Use the computer in accordance with the system requirements (9000-618-148).</li> </ul>
Camera is not detected by the software	USB driver not up to date	<ul style="list-style-type: none"> <li>› Install the up-to-date USB driver.</li> </ul>
Camera is not correctly detected by the software under Windows 7	Outdated chipset driver (especially for chipsets from Intel, type C216 or C220)	<ul style="list-style-type: none"> <li>› Download and install the respective Windows 7 chipset driver from the manufacturer. (The correct driver is supplied for Windows 8 and higher)</li> </ul>
The image is blurred	Resolution set incorrectly	<ul style="list-style-type: none"> <li>› Working in <i>VistaConfig</i> &gt; <i>Camera configuration</i> &gt; <i>Settings</i> select a resolution with width-to-height ratio 4:3.</li> </ul>

### 13.1 Proof interchangeable head

Error	Possible cause	Remedy
Image contains a high amount of red; healthy tooth substance is not properly green	Penetration of external light	<ul style="list-style-type: none"> <li>› Check the position of the spacer (directly on the tooth).</li> <li>› Turn off or dim source of external light (e.g. operating light); darken the room.</li> </ul>

### 13.2 Proxi interchangeable head

Error	Possible cause	Remedy
Image is too light in a specific region	The angle of the camera to the tooth is not ideal	<ul style="list-style-type: none"> <li>› Change the holding angle of the camera to the tooth.</li> </ul>
Snow effect on the image	Clearance of the camera to the tooth is too high, no optimum illumination	<ul style="list-style-type: none"> <li>› Ensure that the spacer does not come into contact with the teeth.</li> </ul>
	Camera used without spacer	<ul style="list-style-type: none"> <li>› Always use a spacer for imaging using the Proxi interchangeable head.</li> </ul>
Dark shadow in the dentine	Hygienic protective cover or optical element soiled	<ul style="list-style-type: none"> <li>› Check the hygienic protective cover, clean or replace if necessary.</li> <li>› Check the optical element and clean if necessary (see "11.1 Cleaning the optical element").</li> </ul>

Error	Possible cause	Remedy
<b>Image is too light or too dark</b>	Incorrect settings in the imaging software	<ul style="list-style-type: none"><li>› Alter the brightness of the image in the imaging software.</li><li>› Adapt the brightness in the configuration of the imaging software to change the brightness settings.</li></ul>
<b>Too many reflections in the image</b>	Saliva in the mouth	<ul style="list-style-type: none"><li>› Dry the row of teeth with a cloth or compressed air.</li><li>› Change the holding angle of the camera lightly.</li></ul>
	Teeth with large-surface fillings and a small surface with intact enamel in the image section	<ul style="list-style-type: none"><li>› This image does not permit exact analysis.</li></ul>

---

 Appendix

## 14 Handover record

This document confirms that a qualified handover of the medical device has taken place and that appropriate instructions have been provided for it. This must be carried out by a qualified adviser for the medical device, who will instruct you in the proper handling and operation of the medical device.

Product name	Order number (REF)	Serial number (SN)

- Visual inspection of the packaging for any damage
- Unpacking the medical device and checking for damage
- Confirmation of the completeness of the delivery
- Instruction in the proper handling and operation of the medical device based on the operating instructions

**Notes:**

**Name of person receiving instruction:****Signature:**

**Name and address of the qualified adviser for the medical device:**

**Date of handover:****Signature of the qualified adviser for the medical device:**

--	--

## 15 Country representatives

Country	Address
GB 	<b>UK Responsible Person:</b> Duerr Dental (Products) UK Ltd. 14 Linnell Way Telford Way Industrial Estate Kettering, Northants NN 16 8PS
UA 	<b>Уповноважений представник в Україні:</b> Приватне підприємство "Галіт" вул. 15 квітня, 6Є, с. Байківці, Тернопільський р-н, 47711, Україна тел.: 0800 502 998; +38 050 338 10 64 <a href="http://www.galit.te.ua">www.galit.te.ua</a> ; e-mail: <a href="mailto:office@galit.te.ua">office@galit.te.ua</a>  Виробник: Дюрр Дентал ЕсЕ Хьолфігхаймер Штрассе 17, Д-74321 Бітігхайм-Біссінген, Німеччина email: <a href="mailto:info@duerrdental.com">info@duerrdental.com</a>
CH 	<b>Schweizer Bevollmächtigter:</b> DÜRR DENTAL SCHWEIZ AG Grabenackerstraße 27 8156 Oberhasli Switzerland













**Hersteller / Manufacturer:**

DÜRR DENTAL SE  
Höpfigheimer Str. 17  
74321 Bietigheim-Bissingen  
Germany  
Fon: +49 7142 705-0  
[www.duerrdental.com](http://www.duerrdental.com)  
[info@duerrdental.com](mailto:info@duerrdental.com)

