

User Manual

Vacuklav[®] 23 B+ Vacuklav[®] 31 B+

Steam sterilizer

from software version 5.20



EN

Dear customer,

We thank you for your confidence demonstrated by the purchase of this MELAG product. As an owner-run and operated family concern founded in 1951, we have a long history of successful specialization in hygiene products for practice-based use. Our focus on innovation, quality and the highest standards of operational reliability has established MELAG as the world's leading manufacturer in the instrument reprocessing and hygiene field.

You, our customer are justified in your demand for the best products, quality and reliability. Providing **“competence in hygiene”** and **“Quality – made in Germany”**, we guarantee that these demands will be met. Our certified quality management system is subject to close monitoring: one instrument to this end is our annual multi-day audit conducted in accordance with EN ISO 13485. This guarantees that all MELAG products are manufactured and tested in accordance with strict quality criteria.

The MELAG management and team.

CE 0197

Contents

1 General guidelines	5
Symbols used	5
Formatting rules	5
Disposal	5
2 Safety	6
3 Performance specifications	8
Intended use	8
Sterilization procedure	8
Type of the feed water supply	8
Safety equipment	9
Performance characteristics of sterilization programs	9
Program sequences	10
Overview of programs	11
4 Description of the device	13
Scope of delivery	13
Views of the device	14
Symbols on the device	15
Operating panel	17
Load mounts	17
5 First steps	18
Setup and installation	18
Feed water supply	18
Wastewater connection	19
Switching on the steam sterilizer	19
Opening and closing the door	19
Setting the date and time	19
6 Important information for routine operation	21
7 Sterilization	22
Preparing the load	22
Loading the steam sterilizer	23
Selecting the program	25
Additional program options	26
Starting the program	27
Program run	27
Program end	28
Manual program abort	28
Removing the sterile material	30
Storing sterile material	30
8 Logging	31
Batch documentation	31
Output media	32
Outputting logs immediately and automatically	34
Subsequent log output	35

Displaying the log memory 36

Deleting logs in the internal log memory 36

Reading logs correctly 37

9 Function tests 39

 Automatic functional checks 39

 Manual functional checks 39

 Batch-related tests 39

 Vacuum test 39

 Bowie & Dick test 40

 Checking the quality of the feed water 41

 Checking the preheating temperature of the chamber 41

10 Maintenance 42

 Servicing intervals 42

 Cleaning 42

 Avoiding staining 44

 Replacing the door seal 44

 Replacing or sterilizing the sterile filter 45

 Cleaning the filter in the chamber 47

 Maintenance 47

11 Pause times 48

 Frequency of sterilization 48

 Operating pauses 48

 Decommissioning 48

 Transport 49

 Recommissioning after relocation 49

12 System malfunctions 50

 Information messages 51

 Warnings 52

 Malfunction messages 55

 Opening the door in an emergency following a power outage 61

 Replacing the device fuses 62

13 Technical data 63



14 Accessories and spare parts 64

Glossary 65

1 General guidelines

Please read this user manual carefully before commissioning the device. The manual includes important safety instructions. Make sure that you always have access to digital or printed version of the user manual. Should the manual no longer be legible, is damaged or has been lost, you can download a new copy from MELAG download centre at www.melag.com.

Symbols used

Symbol	Explanation
	Indicates a dangerous situation, which if not avoided, could entail slight to life-threatening injuries.
	Draws your attention to a situation, which if not avoided, could result in damage to the instruments, the practice fittings or the device.
	Draws your attention to important information.

Formatting rules

Example	Explanation
see Chapter 2	Reference to another text section within this document.
Universal- Program	Words or phrases appearing on the display of the device are marked as display text.

Disposal

MELAG devices are synonymous with high quality and a long life-span. When you eventually need to de-commission your MELAG device, the required disposal of the device can take place with MELAG in Berlin.

Dispose of accessories and consumption media which you no longer require in the appropriate manner. Comply with all relevant disposal specification in terms of possibly contaminated waste.

The packaging protects the device against transport damage. The packaging materials have been selected for their environmentally-friendly disposability and can be recycled. Returning the packaging to the material flow reduces the amount of waste and saves raw materials.

2 Safety



When operating the device, comply with the following safety instructions as well as those contained in subsequent chapters. Use the device only for the purpose specified in these instructions. Failure to comply with the safety instructions can result in injury and/or damage to the device.

Qualified personnel

- As with the preceding instrument reprocessing, only competent personnel should undertake sterilization using this steam sterilizer.
- The operator must ensure that the users have been trained in the operation and safe handling of the device.
- The operator must ensure that users are regularly trained in the operation and safe handling of the device.

Setup, installation and commissioning

- Check the device after unpacking for any damage suffered during transport.
- The device should only be setup, installed and commissioned by MELAG authorized persons.
- The connections for electrical provision and water supply and discharge must be setup by trained personnel.
- Using the optional electronic leak detector (water stop) minimizes the risk of water damage.
- The device is not suitable for operation in explosive atmospheres.
- Install and operate the device in a frost-free environment.
- The device is conceived for use outside the patient area. The device should be located a minimum of 1.5 m radius away from the treatment area.
- The documentation media (computer, CF card reader etc.) must be placed in such a way that they cannot come into contact with liquids.
- Observe all the information contained in the technical manual during commissioning.

Power cable and power plug

- Comply with all legal requirements and locally-specified connection conditions.
- Never operate the device if the plug or power cable are damaged.
- The power cable or plug should only be replaced by authorized technicians.
- Never damage or alter the power plug or cable.
- Never unplug by pulling on the power cable. Always take a grip on the plug.
- Ensure that the power cable does not become jammed in.
- Never lead the cable along a source of heat.
- Never fix the power cable with sharp objects.
- The mains socket must be freely accessible after installation so that the device can be disconnected from the electrical mains at any time if necessary by pulling the mains plug.

Spring safety valve

- The free movement of the valve rod must be guaranteed. For example, the spring safety valve must not be taped or blocked. Install the device in such a way that the proper functioning of the spring safety valve is guaranteed.

Reprocessing and sterilization

- Follow the manufacturer's instructions of your textile articles and instruments regarding their reprocessing and sterilization.
- Comply with the relevant standards and directives applicable to the reprocessing and sterilization of textiles and instruments (in Germany e.g. from the RKI and DGSV).
- Only ever use packaging material and systems which have been cleared by their manufacturer for steam sterilization.

Program abort

- Please observe that depending on the time of the program abort, opening the door following a program abort can lead to hot steam leaving the sterilization chamber.
- Depending on the time of the program abort, it is possible that the load is unsterile. Observe the clear instructions shown on the display of the device. Sterilize the affected load after re-wrapping again.

Removing the sterile material

- Never use force to open the door.
- Use a tray lifter to remove the tray. Never touch the sterilized equipment, the chamber, the mount or the inside of the door with bare hands. The components are hot.
- Check the packaging on the sterile material for damage when removing it from the steam sterilizer. Should the packaging be damaged, re-pack the load and re-sterilize it.

Transport and storage

- Store and transport the device in a frost-free environment.
- The device should always be carried by two people.
- Use suitable carrying straps to carry the device.

Maintenance

- Maintenance should only be performed by authorized technicians.
- Maintain the specified servicing intervals.
- Only original MELAG spare parts may be used.

Repair

- Never open the device housing. Incorrect opening and repair can compromise electrical safety and pose a danger to the user. The device may only be opened by an authorised technician who must be a qualified electrician (according to VDE 0105-100 or IEC 60050).

Malfunctions

- Should the device issue the same malfunction message repeatedly, turn off the device and if necessary, inform your stockist.
- The device may only be serviced by authorized technicians.

Notification requirement in the event of serious accidents in the European Economic Area

- Please note that all serious accidents which occur in connection with the medical product (e.g. death or serious deterioration in the state of health of a patient) which were presumably caused by the product, must be reported to the manufacturer (MELAG) and the relevant authority of the member state, in which the user and/or patient resides.

3 Performance specifications

Intended use

This steam sterilizer is designed for application in a medical context, e.g. general practitioners and dental practices. According to EN 13060, this steam sterilizer is considered as a steam sterilizer with type B cycles. As a universal steam sterilizer, it is suited to highly-demanding sterilization tasks. It can be used for a range of tasks such as the sterilization of large quantities of instruments with narrow lumen and transmission instruments - both wrapped or unwrapped - and of textiles.



WARNING

Any attempt to sterilize liquids can result in a delay in boiling. This can result in burns and damage to the device.

- Never use this device to sterilize fluids. It is not licensed for the sterilization of fluids.

Sterilization procedure

The steam sterilizer sterilizes on the basis of the fractionated vacuum procedure. This guarantees the complete and effective wetting/penetration of the sterilization material with saturated steam.

The steam sterilizer uses a separate steam generator to generate sterilizing steam. Steam is generated upon program start and led into the sterilization chamber. This establishes a pre-defined pressure and temperature. The sterilization chamber is protected against overheating. You can sterilize large quantities of instruments or textiles directly one after each other, thereby achieving excellent drying results.

Automatic preheating

If preheating is activated, the cold chamber is heated up to the preheating temperature of the particular program before program start, or this temperature is held between two program runs. This reduces program times and the accretion of condensation, thus improving drying results.

Type of the feed water supply

The steam sterilizer works with a one-way feed water system. This means that it uses fresh feed water (demineralized or distilled water) for every sterilization procedure. The quality of the feed water is subject to permanent monitoring via integrated conductivity measurement. If combined with instrument decontamination of the instruments, this serves largely to prevent stain accretion on the instruments and soiling of the steam sterilizer.

The supply with feed water for steam generation is performed automatically via an internal storage tank or a water treatment unit (e.g. MELAdem 40, MELAdem 47).

The technical manual provides detailed information regarding connection to a water treatment unit.

Safety equipment

Internal process monitoring

A process evaluation system is integrated in the electronics of the steam sterilizer. It compares the process parameters (such as temperature, time and pressure) during a program run. It monitors the parameters in terms of their threshold values during control and regulation and guarantees safe and successful sterilization. A monitoring system checks the device components of the steam sterilizer for their functionality and interplay. If one or more parameters exceeds pre-determined threshold values, the steam sterilizer issues warning or fault messages and if necessary, aborts the program. In the case of a program abort, follow the instructions on the display.

The steam sterilizer uses an electronic parameter control. This enables the steam sterilizer to optimise the total operating time of a program in dependence on the load.

Door mechanism

The steam sterilizer constantly checks pressure and temperature in the sterilization chamber and prevents the door from being opened when over-pressure has built up.

Quantity and quality of the feed water

The quantity and quality of the feed water is automatically checked before every program start.

Performance characteristics of sterilization programs

The results in this table show which inspections were performed on the steam sterilizer. The marked field shows compliance with all the applicable sections of the standard EN 13060.

Type tests	Universal-Program	Quick-Program B	Quick-Program S	Gentle-Program	Prion-Program
Program type in accordance with EN 13060	Type B	Type B	Type S	Type B	Type B
Dynamic pressure test of the sterilization chamber	X	X	--	X	X
Air leakage	X	X	X	X	X
Empty chamber test	X	X	X	X	X
Solid load	X	X	X	X	X
Porous partial load	X	--	--	X	X
Porous full load	X	--	--	X	X
Simple hollow body (Hollow body B)	--	--	X	--	--
Product with narrow lumen (Hollow body A)	X	X	--	X	X
Single wrapping	X	X	--	X	X
Multiple wrapping	X	--	--	X	X
Drying solid load	X	X	X	X	X
Drying porous load	X	--	--	X	X
Sterilization temperature	134 °C	134 °C	134 °C	121 °C	134 °C
Sterilization pressure	2.1 bar	2.1 bar	2.1 bar	1.1 bar	2.1 bar
Sterilization time	5:30 min	5:30 min	3:30 min	20:30 min	20:30 min
X = Complies with all applicable sections of the standard EN 13060					

Program sequences

Regular sterilization program

A program runs through three phases: the air removal, sterilization and drying phases. After program start, you can follow the program run on the display. It shows the chamber temperature and pressure as well as the time until the end of sterilization or drying.

Program phase	Description
1. The air removal phase (fractionation)	The air removal phase comprises the conditioning and the evacuation phase. During conditioning, steam is repeatedly injected into the sterilization chamber to generate over-pressure. The mixture of air and steam is then removed repeatedly (evacuation). This procedure is also called the fractionated vacuum procedure.
2. Heating phase	The heating phase follows the air removal phase. The continued steam intake into the sterilization chamber leads to an increase in pressure and temperature which continues until the program-specific sterilization parameters have been reached.
3. Sterilization phase	Once the pressure and temperature correspond to the program-dependent nominal values, the actual sterilization phase begins. The sterilization time is indicated on the display.
4. Pressure release	The end of the sterilization phase is followed by pressure release with simultaneous emptying of the steam generator.
5. Drying phase	The load is dried using a vacuum (vacuum drying). The drying phase begins after the pressure release.
6. Ventilation	Upon program end, the sterilization chamber is filled with sterile air via the air filter and adjusted to the ambient pressure. The corresponding display message "Ventilate" is displayed

Vacuum test

The vacuum test measures the leakage rate. No real sterilization is performed. The test is performed with a cold, dry and unloaded device.

Program phase	Description
1. Air removal phase (evacuation)	The sterilization chamber is evacuated until the pressure for the vacuum test has been reached.
2. Equilibration time	An equilibration time of 5 min will follow.
3. Measurement time	The measuring time is 10 min. The pressure increase within the chamber is measured during the measurement time. The evacuation pressure and the equilibration time or measurement time are shown on the display.
4. Test end	The display shows the test result, the batch number, the total number of batches and the leakage rate.

Overview of programs

MAIN menu

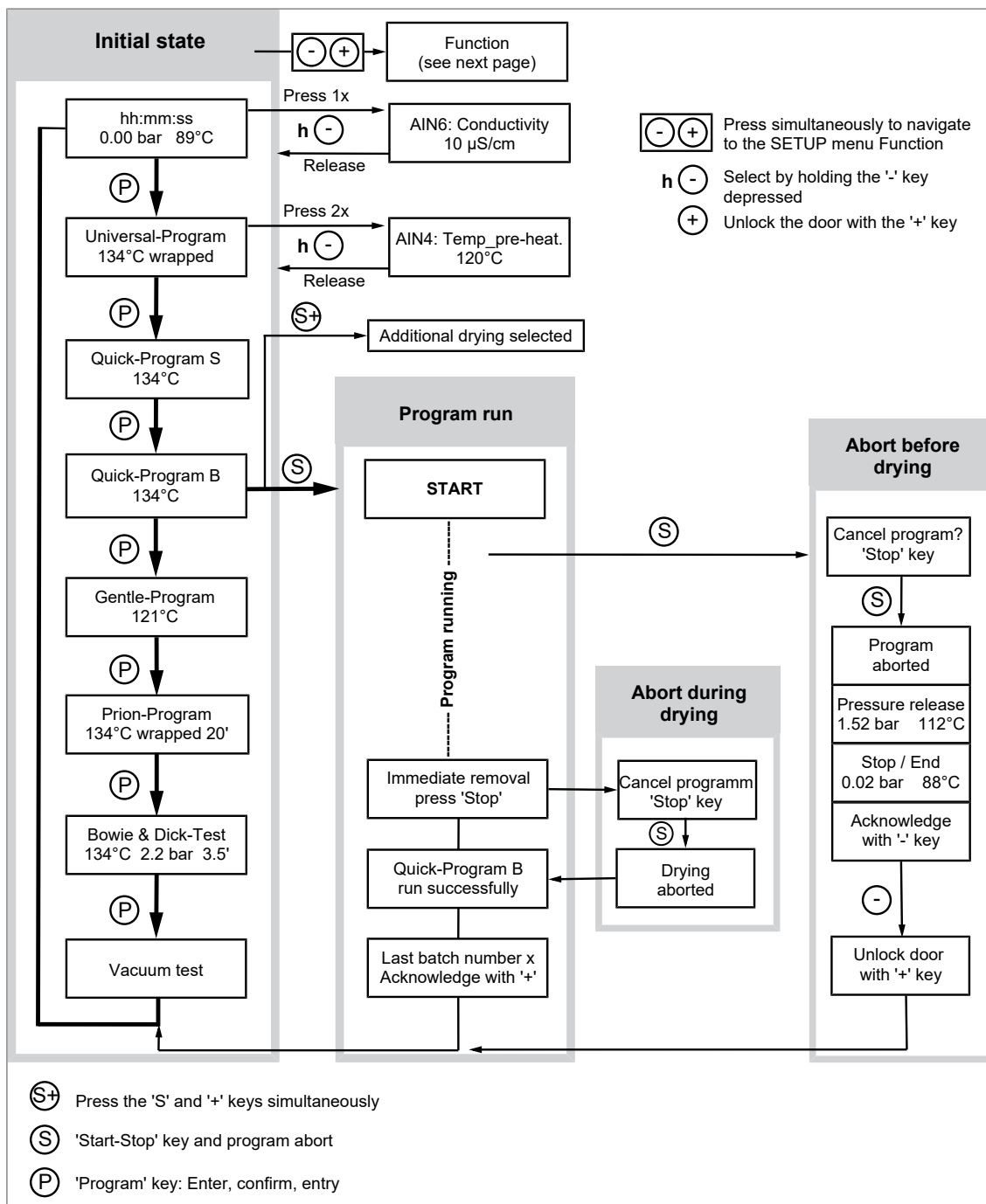

Functions of the SETUP menu

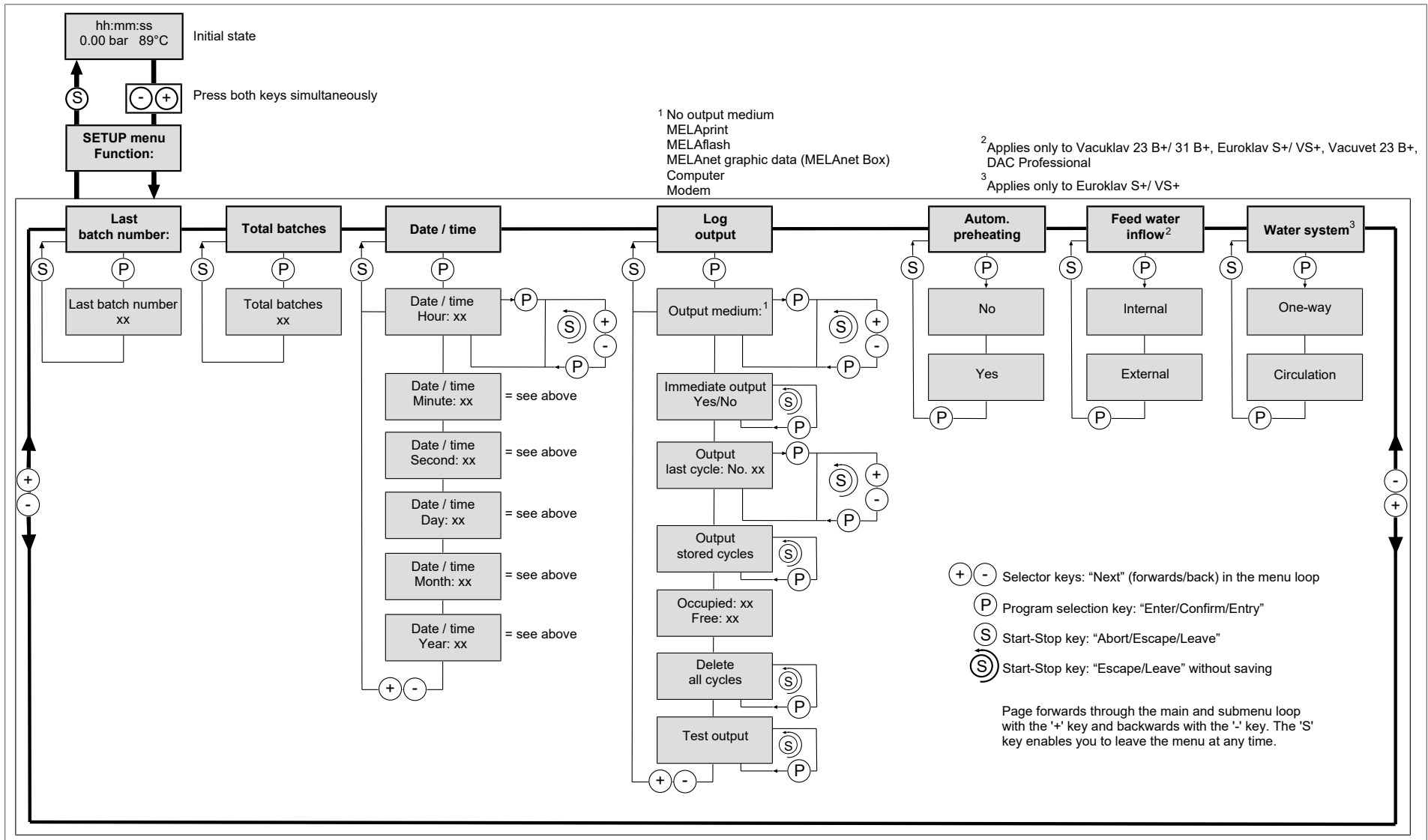

4 Description of the device

Scope of delivery

Please check the scope of delivery before setting up and connecting the device.

Standard scope of delivery

- Vacuklav 23 B+ or Vacuklav 31 B+
- User manual
- User manual: Accessories for small steam sterilizers
- Technical manual
- Warranty certificate
- Manufacturer's inspection report and declaration of conformity
- Record of installation and setup
- Tray lifter
- Hose for emptying the interior storage tank
- Key for the chamber filter
- Lever for emergency release of the door
- 2x replacement device fuse on the inside of the steam sterilizer door

Views of the device

Front

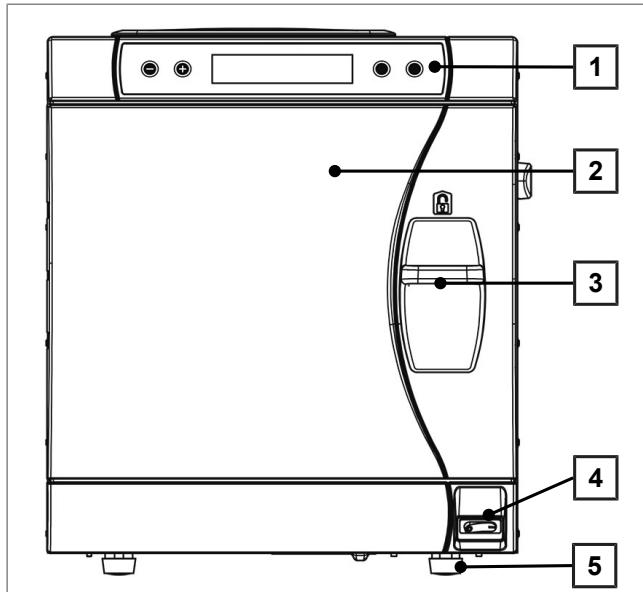

- 1 Operating and display panel
- 2 Door, swings open to the left
- 3 Slide locking grip
- 4 Power switch
- 5 Front device foot (adjustable)

Rear panel

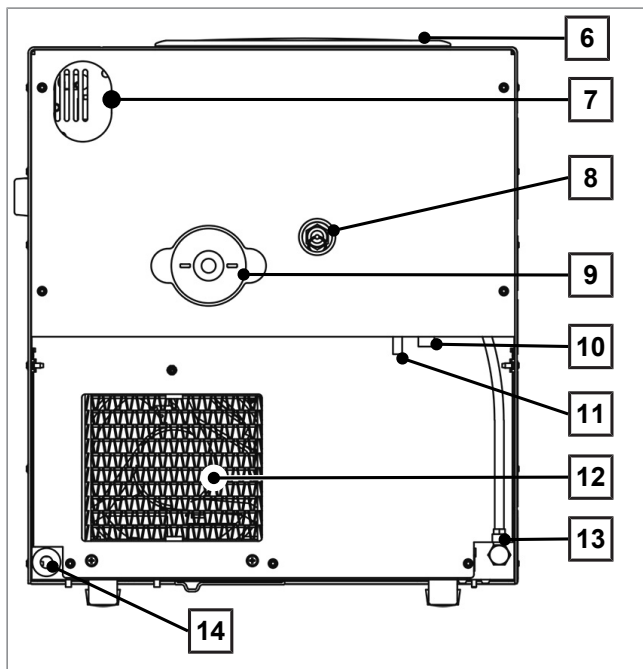

- 6 Tank lid
- 7 Slot for optional upgrade with the safety combination EN 1717
- 8 Spring safety valve
- 9 Sterile filter
- 10 Emergency overflow hose
- 11 One-way outlet (optional)
- 12 Cooler
- 13 Feed water inflow from water treatment unit
- 14 Power cable

View of the interior

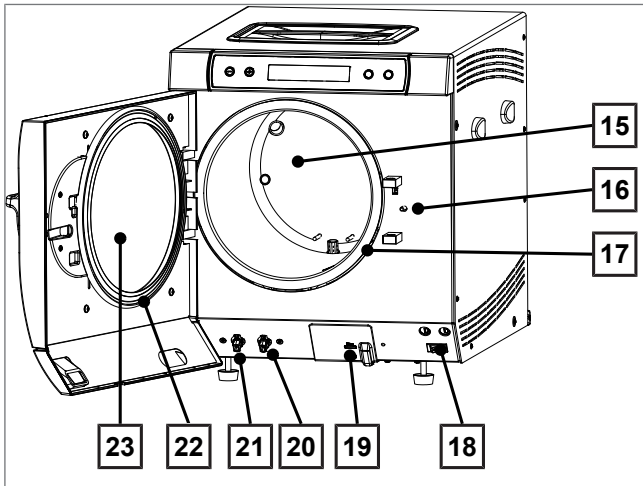

- 15 Sterilization chamber
- 16 Door locking pin
- 17 Chamber seal face
- 18 2 device fuses
- 19 Serial data and printer connection (RS232)¹⁾
- 20 Connection for emptying the internal storage tank - feed water
- 21 Connection for emptying the internal storage tank - wastewater
- 22 Door seal
- 23 Round blank

Symbols on the device

Type plate



Manufacturer of the medical device



Date of manufacture of the medical device



Identifies a medical device



Medical device serial number from the manufacturer



Article number of the medical device



Information about the chamber volume



Operating temperature of the device



Operating pressure of the device



Electrical connection of the device: AC current



Internal device fuse, rated in amperes [A]

¹⁾hidden behind white cover



The user manual includes important safety information. Failure to comply with these instructions can result in injury and material damage.



Read this user manual carefully before commissioning the device.



In affixing this CE mark, the manufacturer declares that this medical product fulfils the basic requirements of the Medical Device Directive. The four-digit number confirms that this is monitored by an approved certification agency.



In affixing this CE mark, the manufacturer declares that this product fulfils the basic requirements of the Pressure Equipment Directive. The four-digit number confirms that this is monitored by an approved certification agency.



The device may not be disposed as domestic waste. The vendor is responsible for appropriate disposal of the device - it must be delivered to the vendor to be disposed of.

Front of the device

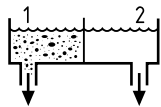

Bleed valves, internal storage tanks:

1 = Wastewater side 2 = Feed water side

Symbols on the power switch



Switching on device



Switching off device

Operating panel

The operating panel consists of a two-row alphanumerical LC display and four membrane keys.

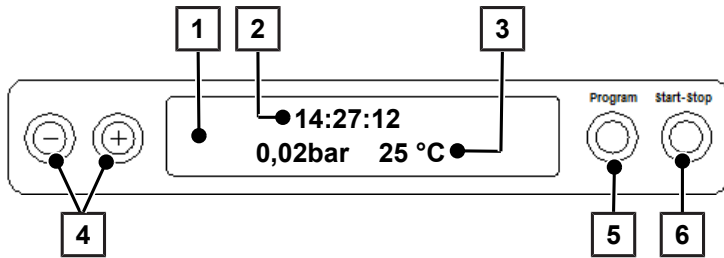

- 1 **2-row LC display**
for displaying the program status and parameters
- 2 Time (h:min:s)
- 3 Chamber pressure (bar) and (steam) temperature (°C)
- 4 **Function keys '-' and '+'**
for the selection, setting and display of special functions: print, date/time, preheating, total batches, conductivity, acknowledge error, key '+' for unlocking the door
- 5 **Program selection key 'P'**
for selecting the sterilization program / test program and selection / setting of the options (submenus) of the special functions
- 6 **Start – Stop key 'S'**
for starting programs, aborting programs / drying and controlling the special functions

Initial state

Each time the device is switched on, the display changes to the initial state, showing the current time, the chamber pressure in bar and the (steam) temperature in °C.

Load mounts

For detailed information about the different mounts, how to combine them with different load holders and how to use them, please refer to the separate document “User manual: Accessories for small steam sterilizers”.

Mount A Plus

The mount (A Plus) is standard and can accommodate either five trays or three MELAstore Boxes 100 when turned 90°.

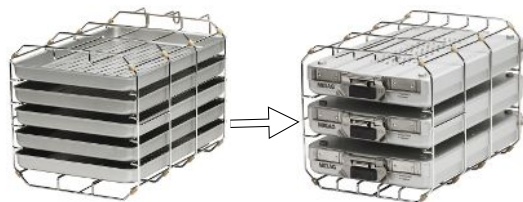

Mount D

The mount (D) can accommodate two tall sterilization containers (e.g. MELAstore Box 200) or four trays (when turned 90°).



5 First steps

Setup and installation



PLEASE NOTE

Comply with the specifications of the technical manual during setup and installation. This contains all building-side requirements.

Record of installation and setup

The record of installation and setup is to be completed by the responsible stockist and a copy sent to MELAG as proof of the correct setup, installation and initial commissioning. This is a constituent part of any guarantee claim.

Feed water supply

Steam sterilization requires the use of distilled or demineralized water, known as feed water. Annex C of EN 13060 specifies the guideline values to be observed.

The feed water supply is effected either via the internal storage tank or via a separate water treatment unit (e.g. MELAdem 40/MELAdem 47).

When using the internal storage tank for the feed water supply, it is necessary to refill feed water side.

A water treatment unit is connected to the domestic water supply. It produces the feed water which the steam sterilizer requires for steam generation. The use of a water treatment unit guarantees the availability of sufficient feed water. You no longer have to manually fill the feed water side of the internal storage tank.

Using the internal water storage tank

When feed water is supplied via the internal storage tank, this needs to be filled manually from time to time. The steam sterilizer will issue notification at the relevant time.

The internal storage tank holds max. 4 l. This volume of feed water is sufficient for up to 7 sterilization runs.

The steam-generating system requires at least 1 l to ensure the feed water supply.

- ▶ To fill the storage tank with fresh feed water remove the lid and fill the right-hand chamber of the storage tank (right) with fresh feed water up to the MAX mark.

Setting the feed water supply on the steam sterilizer

The **INTERNAL** function must be set in order to enable feed water supply via the internal storage tank. The **EXTERNAL** function must be set in order to enable feed water supply via a water treatment unit.

1. Select the SETUP menu **Function** by pressing the '+' and '-' keys simultaneously. The display will show the notification **Function: Last batch number**.
2. Navigate using the '+' or '-' key until the display shows: **Function: Feed water supply**.
3. Press the 'P' key. The display shows the option currently set.
4. Press the 'P' key again to change to the desired setting (**INTERNAL/EXTERNAL**).
5. Press the 'S' key to save the setting and to leave the menu.

Repeated pressing of the 'S' key enables you to leave the menu entirely and return to the display basic state.

Wastewater connection

The wastewater can either be collected in the internal storage tank on the wastewater side (left) and be removed manually or be let out automatically via the one-way outlet. An upgrade kit can be ordered to connect the steam sterilizer to the wastewater. Detailed information regarding the connection to the wastewater is provided in the technical manual.

Switching on the steam sterilizer

- ✓ *The steam sterilizer is connected to the electricity supply.*
- ✓ *The door is closed.*

- ▶ The steam sterilizer is switched on at the power switch.
- ➔ The display switches between the initial state and the message **Unlock door with '+' key**, as long as the door is closed.



PLEASE NOTE

Remove all accessories from the sterilization chamber directly after switching on for the first time and before initial commissioning.

After device activation, a heating up time of approx. 5 min is required depending on the device type. A program will be started only after the target temperature has been reached.



PLEASE NOTE

When switching off the device via the power switch, wait 3 s before switching it back on.

Opening and closing the door

The door can only be opened when the display shows **Acknow. with '+' key / Unlock door with '+' key**.

1. Press the '+' key. You can open the door after hearing an audible click.
2. To shut the door, press it lightly against the device and slide the slide locking grip downwards to its at the same time.

Setting the date and time

Correct batch documentation requires the correct date and time setting on the steam sterilizer. Ensure that you take into account any clock change, as this is not adjusted automatically. Set the date and time as follows:

1. Select the menu **Function** by pressing the '+' and '-' keys simultaneously.
 - ➔ The display will show the message **Function: Last batch number**.
2. Navigate in the **Function** menu using the '+' or '-' keys until the display shows:

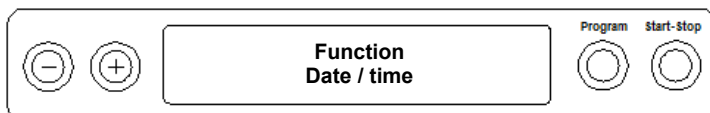

3. Press the 'P' key to confirm.
 - ➔ The current hour is displayed.
4. Choose one of the following setting possibilities using the '+' or '-' key: Hour, minute, second, day, month, year.

5. To e.g. adjust the hours parameter, press the 'P' key to confirm.
 - ↳ The current value flashes on the display.
6. You can increase or reduce the value using the '+' and '-' keys.
7. Confirm with the 'P' key in order to save the value.
 - ↳ The current value set no longer flashes on the display.
8. Proceed in a similar fashion to alter the other parameters.
9. After completing the settings, press the 'S' key to leave the menu.
 - ↳ The display will show **Function: Date / Time.**
10. Repeated pressing of the 'S' key enables you to leave the menu and the display returns to its initial state.

6 Important information for routine operation

Comply with the recommendations issued by the Robert Koch Institute (RKI) and the information contained in DIN 58946-7.

Manufacturer’s recommendation for the routine operation of type B steam sterilizers²⁾

When is it necessary to make checks?	How should the checks be made?
Once per working day	<ul style="list-style-type: none"> ▪ Visual check of the door seal and the door lock for damage ▪ Check the operating media (electricity, feed water and water connection if necessary) ▪ Check the documentation media (printer paper, computer, network) <p>MELAG recommends performing the steam penetration test with MELAcontrol Helix/MELAcontrol Pro in the Universal-Program (test system in accordance with EN 867-5).</p>
Once a week	<ul style="list-style-type: none"> ▪ Vacuum test <p>Tip: In the mornings before starting work – the steam sterilizer must be cold and dry</p>
Batch-related tests	<p>With “Critical B” instruments:</p> <ul style="list-style-type: none"> ▪ MELAcontrol Helix/MELAcontrol Pro must be used as batch control with every sterilization cycle. <p>With “Critical A” instruments:</p> <ul style="list-style-type: none"> ▪ The process indicator (type 5 in accordance with EN ISO 11140) must be used as batch control with every sterilization cycle. <p>With “Critical A + B” instruments:</p> <ul style="list-style-type: none"> ▪ MELAcontrol Helix/MELAcontrol Pro must be used as batch control with every sterilization cycle. <p>This simplifies the working procedure and increases security. You can omit the daily steam penetration test with MELAcontrol Helix/MELAcontrol Pro (see above). The use of another test system in accordance with EN 867-5 is possible. The number of the available test systems means that MELAG is not able to provide technical support when using a different system.</p>



PLEASE NOTE

Document the results of the tests.

- The indicator test strips used need not be stored.

²⁾in accordance with the current recommendations from the Robert Koch Institute

7 Sterilization

Preparing the load

Always clean and disinfect properly before sterilization. Only in this way is it possible to guarantee the subsequent sterilization of the load. The materials used, cleaning agents and reprocessing procedure are of decisive significance.



NOTICE

Only ever operate the steam sterilizer with a sterile filter inserted.

Reprocessing textiles



WARNING

The incorrect reprocessing of textiles, e.g. a textile package can prevent steam penetration or produce poor drying results.

The textiles could not be sterilized.

Comply with the following points when reprocessing textiles and putting the textiles in sterilization containers:

- ▶ Comply with both the manufacturer's instructions of the textiles regarding reprocessing and sterilization as well as the relevant standards and directives (in Germany e.g. from the RKI and DGSV).
- ▶ Arrange the folds in the textiles parallel to each other.
- ▶ Stack textiles vertically wherever possible and not too closely together in the sterilization container. This enables the development of flow channels.
- ▶ If textile packages do not remain together, wrap the textiles in sterilization paper.
- ▶ Only ever sterilize dry textiles.
- ▶ The textiles may not be permitted to come into direct contact with the sterilization chamber; otherwise they will become saturated with condensate.

Reprocessing the instruments

Unwrapped sterile material loses its sterility on contact with ambient air. If you intend to store your instruments sterilely, wrap them in suitable packaging before sterilization.

Ensure the following when reprocessing used and brand-new instruments:

- ▶ Observe both the instrument manufacturer's instructions regarding reprocessing and sterilization as well as the relevant standards and directives (in Germany, for example, from RKI, DGSV and DGUV Regulation 1).
- ▶ Clean the instruments exceptionally thoroughly e.g. using an ultrasonic device or washer-disinfector.
- ▶ Rinse the instruments after cleaning and disinfecting, where possible with demineralised or distilled water and then dry the instruments thoroughly with a clean, non-fuzzing cloth.
- ▶ Use only those care agents suitable for steam sterilization. Consult the manufacturer of the care agents. Do not use any water repellent agents or oils impermeable to steam.
- ▶ When using ultrasonic devices, care equipment for handpieces and washer-disinfectors, comply with the manufacturer's reprocessing instructions.



NOTICE

The presence of residual disinfection and cleaning fluids results in corrosion.

This could result in increased maintenance requirements and a restriction of the steam sterilizer function.

Loading the steam sterilizer

Effective sterilization and good drying is only possible if the steam sterilizer has been loaded correctly.

Ensure the following during loading:

- ▶ Insert trays or sterilization containers in the chamber only with their appropriate mount.

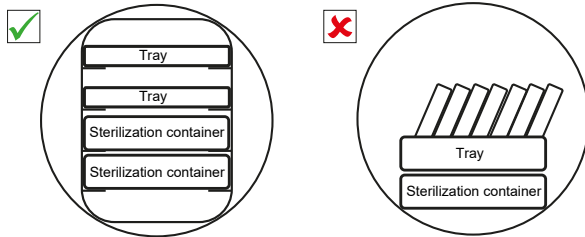

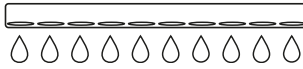
- ▶ Use perforated trays such as those from MELAG. Only in this way can condensate drain off. Non-perforated bases or half-shells for holding the sterilization material lead to poor drying results. 
- ▶ The use of paper tray inserts can result in poor drying results.
- ▶ Wherever possible, ensure the separate sterilization of textiles and instruments in separate sterilization containers or sterilization packaging. This leads to better drying results.

Packaging

Only ever use packaging materials and systems (sterile barrier systems) which fulfil the standard EN ISO 11607-1. The correct use of suitable packaging is important in achieving successful sterilization results. You can use re-usable rigid packaging systems or soft packaging such as transparent sterilization packaging, paper bags, sterilization paper, textiles or fleece.

Closed sterilization containers



WARNING

Risk of contamination due to insufficient steam penetration or poor drying.

- Use only suitable sterilization containers.
- Do not cover the perforations when stacking the sterilization containers so that the condensate can drain off.

Please comply with the following when using closed sterilization containers:

- ▶ Use aluminium sterilization containers. Aluminium retains and conducts heat and thus accelerates drying.
- ▶ Closed sterilization containers must be either perforated or have a valve on at least one side. MELAG sterilization containers (e.g. MELAstore Boxes) fulfil the requirements for successful sterilization and drying.
- ▶ Wherever possible, ensure that sterilization containers are only stacked on top of those of identical size, so that the condensate can run down their sides.
- ▶ Ensure that the perforations are not covered when stacking the containers.

Tip: MELAG sterilization containers fulfil the requirements of EN 868-8 for successful sterilization and drying. They have a perforated lid and base and are fitted with disposable paper filters.

Soft sterilization packaging

Soft sterilization packaging can be used in both sterilization containers and on trays. Comply with the following when using soft sterilization packaging e.g. MELAfol:

- ▶ Arrange soft sterilization packaging in a perpendicular position and at narrow intervals.
- ▶ Place transparent sterilization packages on their edge wherever possible and with the paper side facing downwards.
- ▶ Do not place multiple soft sterilization packages flat on top of each other on a tray or in a container.
- ▶ If the seal seam tears during sterilization, the packaging could be too small or the sealing pulse too low. Re-pack the instruments and if necessary, extend the sealing pulse on the film sealing device or make a double seam. Sterilize the sterilization material again.

Multiple wrapping

The device works with a fractionated vacuum procedure. This permits the use of multiple wrapping.

Mixed loads

Observe the following when sterilizing mixed loads:

- ▶ Always place textiles at the top.
- ▶ Place the sterilization containers at the bottom.
- ▶ Place unwrapped instruments at the bottom.
- ▶ Place the heaviest loads at the bottom.
- ▶ Place transparent sterilization packaging and paper bags at the top - except in combination with textiles. In this case, place them at the bottom.

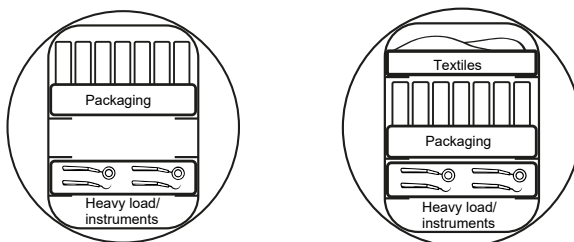

Load versions

Example:

Loading versions*)	Vacuklav 23 B+		Vacuklav 31 B+	
	Instruments	Textiles	Instruments	Textiles
Max. weight per component	2 kg	1.8 kg	2 kg	1.8 kg
Maximum total weight	5 kg	1.8 kg	5 kg	1.8 kg

*) For MELAG mounts, trays, sterilization containers, see [Accessories and spare parts](#) [▶ page 64].

Loading patterns designed especially for the dental sector are available from the download area of the MELAG website: www.melag.com and in the separate document "User manual: Accessories for small steam sterilizers".

Selecting the program

You can switch between the initial state and the desired program using the program selection key 'P'.

Now select the sterilization program according to how and whether the sterilization material is wrapped. It is also necessary to take into account the temperature resistance of the sterilization material.

The following table shows which program is to be selected for which sterilization material.

Overview of sterilization programs

	Universal-Program	Quick-Program B	Quick-Program S	Gentle-Program	Prion-Program
Sterilization temperature	134 °C	134 °C	134 °C	121 °C	134 °C
Sterilization pressure	2.1 bar	2.1 bar	2.1 bar	1.1 bar	2.1 bar
Sterilization time	5:30 min	5:30 min	3:30 min	20:30 min	20:30 min
Operating time ³⁾	approx. 30 min	approx. 30 min	approx. 20 min	approx. 45 min	approx. 45 min
Drying	20 min	10 min	5 min	20 min	20 min

Overview of the use of the respective sterilization programs

Program	Packaging	Especially suitable for	Load
Universal-Program	Single and multiple wrapping	Mixed loads, transmission instruments, products with narrow lumen, simple hollow bodies	Instruments 5 kg Textiles 1.8 kg
Quick-Program B	Single wrapped and unwrapped instruments (no textiles)	Transmission instruments, products with narrow lumen, simple hollow bodies	Single wrapped 1.5 kg Unwrapped 5 kg
Quick-Program S	Only unwrapped (no textiles)	Single massive instruments, simple hollow bodies	Unwrapped instruments 5 kg
Gentle-Program	Single and multiple wrapped	Larger quantities of textiles, thermo-unstable equipment (e.g. plastic, rubber articles), mixed loads, products with narrow lumen, simple hollow bodies	Textiles 1.8 kg or thermo-unstable equipment 5 kg
Prion-Program	Single and multiple wrapped	Instruments under suspicion of carrying the danger of infection through abnormally altered proteins (e.g. Creutzfeld-Jacob, BSE), simple hollow bodies	Instruments 5 kg Textiles 1.8 kg

³⁾ without drying, with a full load and dependent on the load and set-up conditions (such as e.g. mains voltage)

Additional program options

Selecting automatic preheating

Automatic preheating is activated in delivery state.

If preheating is activated, the cold chamber is heated up to the preheating temperature of the particular program before program start, or this temperature is held between two program runs. This reduces program times and the accretion of condensation, thus improving drying results.



PLEASE NOTE

The steam sterilizer must remain continually activated for the automatic preheating. MELAG recommends activating the automatic preheating function.

To alter this setting proceed as follows:

1. Select **Function** menu by pressing the '+' and '-' keys simultaneously until the display shows **Function: Last batch number**.
2. Navigate using the '+' or '-' key until the display shows:

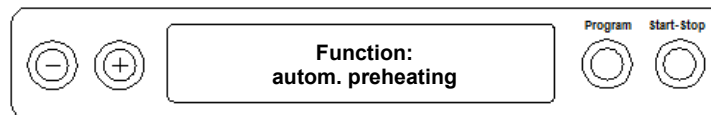

3. Press the 'P' key to confirm.
 - ↳ The display will show the option currently set e.g. **Preheating YES**.
4. Pressing the 'P' key again makes the display switch to **Preheating NO**.
 - ↳ The preheating function has been deactivated.
5. Press the 'S' key twice to leave **Function: Autom. preheating** and return to the initial state.

Selecting additional drying

The **Additional drying** function extends the drying time by 50 % to perform difficult drying tasks.

- ▶ Press the 'S' and '+' keys simultaneously upon program start. The display will show:

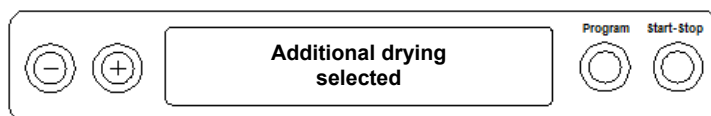

The program run will now begin.

Starting the program



NOTICE

Unsupervised operation of electrical devices, including this steam sterilizer at the operator's risk. MELAG accepts no liability what so ever for any damage resulting from unsupervised operation.

After having selected a program via the program selection key 'P', the display will show both the selected program and sterilization temperature as well as whether the program is suitable for wrapped or unwrapped loads.

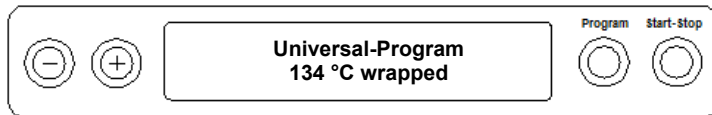

- ▶ Press the 'S' key to start the program.
The steam sterilizer checks the feed water supply and its conductivity.



PLEASE NOTE

When the Quick-Program S is started, the warning message **Attention: Unwrapped instruments only** appears on the display.

If the load contains exclusively unwrapped instruments, press the 'S' key again to confirm and to start the program.

Program run

After starting the program, you can follow the program run in the display. It shows the chamber temperature and pressure as well as the time until the end of sterilization or the drying time which has passed.

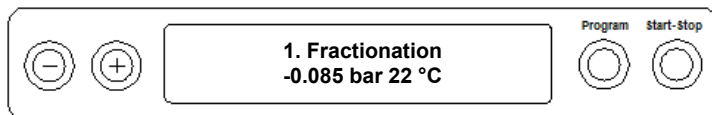

Sterilization phase

The display enables you to see whether the sterilization phase has already been completed successfully. The time left in the sterilization phase is shown in the display in alternation with the pressure and temperature.

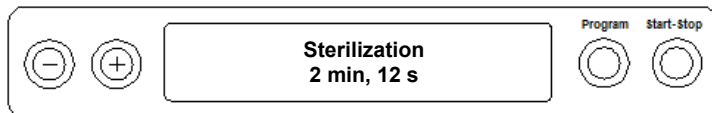

Drying phase

The regular drying time for the Quick-Program S amounts to 5 min. For the Quick-Program B 10 min and for all other programs 20 min. The display will show the corresponding message during the drying phase.

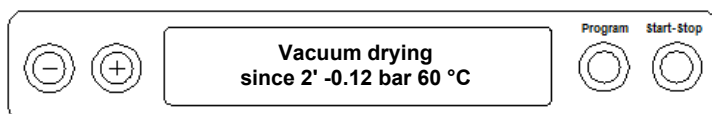

The steam sterilizer provides excellent drying of the sterile material. If difficult-to-dry items require better drying, you can undertake the following steps to improve drying:

- ▶ Load the steam sterilizer properly. Stand e.g. the transparent and paper sterilization packaging upright, see [Loading the steam sterilizer](#) [▶ page 23]. Use the optional package holder if necessary.
- ▶ Activate the function **Additional drying**, see [Selecting additional drying](#) [▶ page 26].

Program end

When the program has been completed successfully, the display shows:

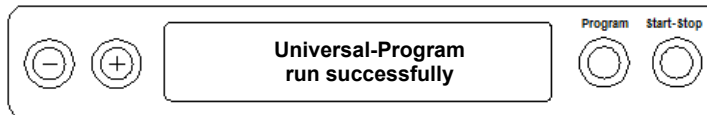

If immediate output after program end is activated in **SETUP menu Function > Last batch number**, then the log of the completed program is output to the activated output media after the door is opened, see [Logging](#) [▶ page 31].

Manual program abort

You can abort a current program in all phases. If you abort the program before drying begins, the load remains **unsterile**.



WARNING

Hot steam can be released from the device when opening the door after a program abort.

This could result in scalding.

- Use a tray lifter to remove the tray.
- Never touch the sterile material, the sterilization chamber or the door with unprotected hands. The components are hot.



NOTICE

Aborting a running program by switching off the power switch can result in the egress of hot steam from the sterile filter and will cause the soiling of the sterile filter.

- Never abort a program by switching off at the mains.

Program abort before the start of drying



WARNING

Danger of infection from early program abort

Aborting a program before the drying phase begins means that the load is unsterile. This endangers the health of your patients and practice team.

- Re-pack the load if necessary.
- Repeat the sterilization of the load.

Proceed as follows to abort the program before drying:

1. Press the 'S' key.
2. Confirm the following security query **Stop program?** by pressing the 'S' key repeatedly.



PLEASE NOTE

The security query will be displayed for approx. 5 s. If the 'S' key is not pressed again, the program will continue with the usual program run.

Depending on the time of the abort, pressure will be released or the device will be ventilated. A corresponding display text appears on the display.

After pressure release or ventilation, you will be asked to acknowledge the program abort.

The display will alternate between **Stop / End** and **Acknowledge with '-' key**.

3. Press the '-' key.
 - ➔ The display will alternate between **Unlock door with '+' key** and the program previously selected.
4. You can open the door after pressing the '+' key.
 - ➔ The log will contain: **Program stopped / Load not sterile!**

Program abort after the start of drying

You can abort the program during the drying phase via the 'S' key without the steam sterilizer registering a fault.

Should you abort a program after drying has started, the sterilization is having been completed successfully. The steam sterilizer will not issue a malfunction message. You should expect insufficient drying, especially in the case of wrapped sterile material and a full load. Sterile storage requires sufficient drying. To ensure this, allow programs with wrapped sterile material to continue to the end of the drying phase as far as is possible. Unwrapped instruments sterilized in a Quick-Program dry after being removed from their own warmth.

The drying time completed thus far is indicated on the display during the drying phase. This will alternate with the display of:

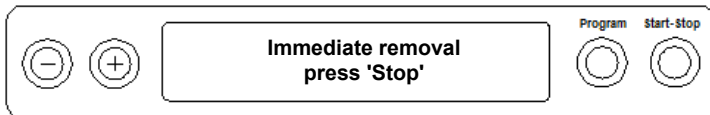

Proceed as follows to abort the program during drying:

1. Press the 'S' key.



PLEASE NOTE

The security query will be displayed for approx. 5 s. If the 'S' key is not pressed repeatedly, the program will continue with the usual program run.

- Confirm the following security query **Immediate removal 'Stop'** by pressing the 'S' key again.

↳ The display confirms the abort with **Drying stopped**.

After ventilation of the chamber, the display will show: **Universal-Program run successfully** in alternation with:

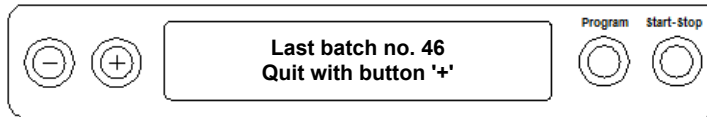

If a printer or other output medium is connected to the steam sterilizer, and **Immediate output** is set to **YES**, the notification **Drying stopped** is recorded on the log.

Removing the sterile material



CAUTION

Danger of burns from hot metal surfaces

- Allow the device to cool sufficiently before opening.
- Do not touch any hot metal parts.



CAUTION

Unsterile instruments resulting from damaged or burst packaging. This endangers the health of your patients and practice team.

- Should the packaging be damaged or have burst after sterilization, wrap the load again and re-sterilize it.

If you remove the sterile material from the device directly after the end of the program, it is possible that the instruments can be partially damp. According to the red brochure of the Arbeitskreis für Instrumentenaufbereitung (AKI), the tolerable residual moisture is – in practice – a few drops of water capable of evaporating within 15 min, but actual pools of water are not acceptable.

Comply with the following specifications when removing the sterile material:

- ▶ Never use force to open the door. This could damage the device or result in the emission of hot steam.
- ▶ Use a tray lifter to remove the tray.
- ▶ Never touch the sterile material, the sterilization chamber, the mount or the inside of the door with bare hands. The components are hot.
- ▶ Check the packaging of the sterilized equipment for damage when removing it from the device. Should the packaging be damaged, re-pack the load and re-sterilize it.

Storing sterile material

The maximum storage time is dependent on the packaging and the storage conditions. Please observe the regulatory requirements for the storage period of sterile materials (in Germany e.g. DIN 58953, Part 8 or the DGSV guidelines) as well as the following listed criteria:

- ▶ Comply with the maximum storage duration in accordance with the packaging type.
- ▶ Do not store the sterile material in the reprocessing room.
- ▶ Store the sterile material in a dust-protected environment e.g. in a closed instrument cabinet.
- ▶ Store the sterile material in an environment protected against moisture.
- ▶ Store the sterile material in an environment protected against excess temperature variations.

8 Logging

Batch documentation

The batch documentation serves as proof of the successful conclusion of the program and represents an obligatory part of quality assurance. The device internal log memory saves such data as the program type, batch and process parameters of all the programs completed.

To obtain the batch documentation, you can output the internal log memory and transfer its data to various output media. This can be performed immediately at the end of every program or at a later point, such as at the end of the day.

Capacity of the internal log memory

The capacity of the internal log memory is sufficient for approx. 40 logs. If the internal log memory is full, the oldest log will be overwritten automatically at the beginning of the next program.

If a printer is connected and the option **Immediate output** has been set to **NO**, a security query will be issued before the saved log is overwritten. For further information about connecting the printer, consult the operating manual of the respective device.

Displaying the daily batch counter

The last batch number of the day is shown on the display after every program run.

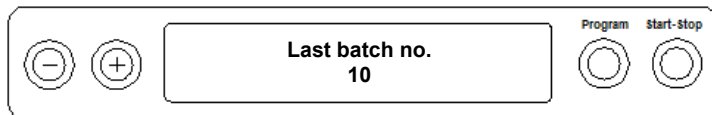

You can also arrange for the batch number to be displayed. To do so:

1. Select SETUP menu **Function** by pressing the '+' and '-' keys simultaneously. The display will show the notification **Function: Last batch number**.
2. Press the 'P' key to display the current daily batch number.
3. To return to the basic state, press the 'S' key twice.

Displaying the total batch counter

You can arrange the display of the number of the batches previously run:

1. Select SETUP menu **Function** by pressing the '+' and '-' keys simultaneously. The display will show the notification **Function: Last batch number**.
2. Navigate using the '+' or '-' keys until the display shows:

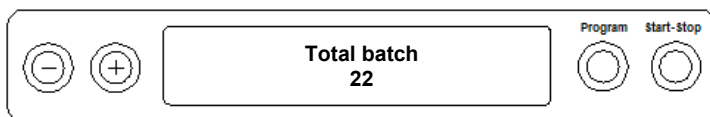

3. Press the 'P' key to display the current total batches counter.
4. To return to the basic state, press the 'S' key twice.

Output media

You are able to output and archive the logs of the completed programs on the following output media:

- MELAflash CF card printer on the CF card
- Computer, e.g. with MELAtrace/MELAvue software (optionally with MELAnet Box)
- MELAprint 42/44 log printer

In its delivery state, an option for log output is not set on the steam sterilizer.



PLEASE NOTE

Further information about the log printer (e.g. the duration of the readability of the log printouts) is specified in the attendant user manual.

Using a computer as an output medium (without a network connection)

In order to be able to use a computer as an output medium, the computer must be connected to the steam sterilizer via the serial interface.

You can connect the steam sterilizer to a computer if the following conditions are fulfilled:

- ✓ *The computer is either fitted with a serial interface or a USB serial adapter is connected.*
- ✓ *The documentation software MELAvue/MELAtrace is installed on the computer.*



PLEASE NOTE

The MELAnet Box is required for integration in the (practice) network.

1. Open the door of the steam sterilizer.
2. Open the white cover of the serial data and printer connection on the steam sterilizer: To do this, use a coin to turn the locking slot (pos. a) on the white cover a quarter of a turn.
3. Remove the cover.
4. Push the metal frame (pos. d) downwards slightly until it unlocks and then fold the metal frame forwards.
5. Push the metal frame (pos. d) downwards slightly until it snaps into place and can no longer fold back independently.
6. Connect the steam sterilizer to the RS232 interface (pos. c) to the computer with a fitting data connection cable.



PLEASE NOTE

If the computer is constantly connected to the steam sterilizer, you can insert the serial cable in the cable guide (pos. b), fold in the metal strap and replace the cover.

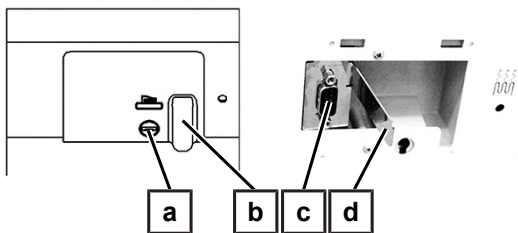

Reading out text logs on the computer

You can use the MELAtrace/MELAviiew software to read out the logs.

The following settings are required to register the computer on the steam sterilizer:

1. Switch on the steam sterilizer.
Wait until the display shows the initial state.
2. Select SETUP menu **Function** by pressing the '+' and '-' keys simultaneously. The display will show **Function: Last batch number**.
3. Navigate with the '+' or '-' keys in the **Function** menu until the display shows **Function: Log output**.
4. Press the 'P' key to select the **Log output – Output medium** submenu.
5. Press the 'P' key again. If an output medium has yet to be chosen, the display will show the **Log output – No output medium** notification.
Navigate using the '+' or '-' keys until the display shows:

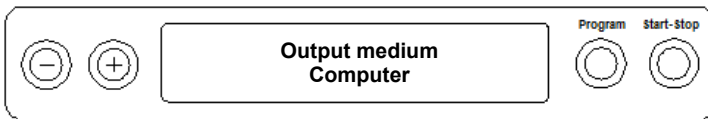

6. Press the 'P' key to confirm. The display switches back to the **Log output – Output medium** menu.
7. Press the 'S' key to return to the SETUP menu **Function: Log output**.
8. After repeated pressing of the 'S' key, the display returns to its initial state.

Opening text logs on the computer

All text logs can be opened and printed using a text editor, a word processing program or a spreadsheet program.



PLEASE NOTE

Graphic logs cab only be displayed with the MELAtrace/MELAviiew (from MELAviiew 3) documentation software.

Each text log (e.g. .PRO, .STR, .STB etc.) must be linked with the text editor to enable the operating system of your computer to open them automatically with a text editor. The meanings of the endings are outlined in the section [Subsequent log output](#) [▶ page 35]. The following examples show how you can link the Windows 10 editor with a specific text log.

1. In Windows Explorer double click on the log file.
2. If the file ending is unfamiliar, Windows 10 will display the following message:

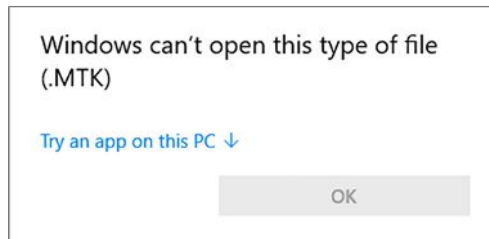

3. Select "Try an app on this PC".

4. Mark the editor and confirm with "OK".

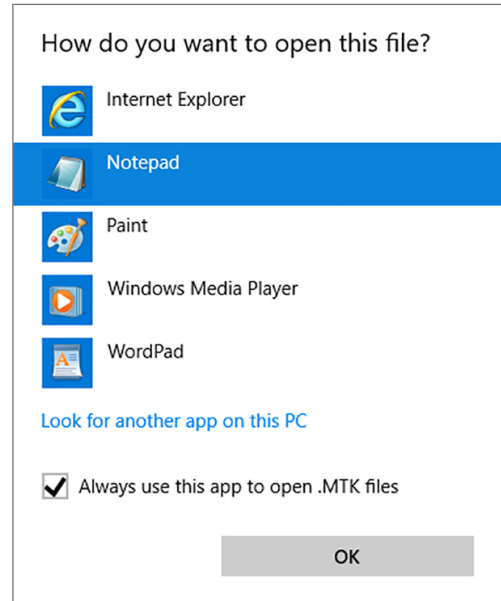

→ You can then open files with this ending via a double-click in Windows Editor.

Alternatively, you can open all text logs with the documentation software MELAtrace/MELAvie (from MELAvie 3).

Outputting logs immediately and automatically

Text log

If you want to output the associated text and graphic logs automatically after the end of a program on an output medium, use the function **Immediate output YES**. This is not set in the delivery state.

The following requirements must be fulfilled in order to issue logs immediately after the end of a program:

- ✓ *In SETUP menu **Function**: **Log output immediate output** is set to **YES**.*
- ✓ *At least one output medium must be selected (computer, log printer MELAprint 42/44).*
- ✓ *The activated output medium must be connected and initialised.*

1. Switch on the steam sterilizer at the power switch.
2. Select SETUP menu **Function** by pressing the '+' and '-' keys simultaneously. The display will show the message **Function: Last batch number**
3. Navigate using the '+' or '-' key until the display shows: **Function: Log output** and press the 'P' key.
4. Navigate using the '+' or '-' key until the display shows:

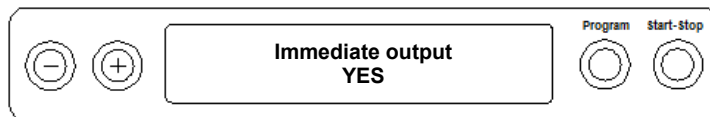

5. Press the 'P' key to change between **Immediate output NO / YES**.
6. Press the 'S' key to save the setting and to leave the menu. The display will show **Function: Log output**.
7. Pressing the 'S' key once again enables you to leave the menu and return to the display initial state.



PLEASE NOTE

If immediate output is unable to issue a log, for example, because the output medium activated is not connected, a warning message will appear. MELAG recommends using the immediate log output function.

Graphic logs

For log output immediately after program end, comply with the following:

- ▶ In SETUP menu **Function: Log output**, **MELANet+graphic data** must be selected as the output medium.
- ▶ The computer or another medium must be connected and initialised.

Subsequent log output

It is possible to issue logs subsequently and independently of the time of a program end. You can choose whether selected or all saved logs (up to 40) are to be output. Use the output media connected for this task e.g. the log printer.

Printing selected logs

To print the subsequently selected logs of a particular program proceed as follows:

1. Select SETUP menu **Function** by pressing the '+' and '-' keys simultaneously. The display will show the message **Function: Last batch number**
2. Navigate using the '+' or '-' key until the display shows: **Function: Log output** and press the 'P' key.
The **Log output – Output medium** menu will be displayed.
3. Navigate using the '+' or '-' key until the display shows: **Last cycle output: no. 40** (as example no. 40).
4. Press the 'P' key. The current log number flashes.
5. To issue a log or another cycle, navigate to the desired number using the '+' or '-' keys until you have reached the desired number, e.g. 25.
6. Press the 'P' key in order to start the output of the selected program. The display will show the message **Output**.

After a successful output, the display returns to its previous setting and shows:

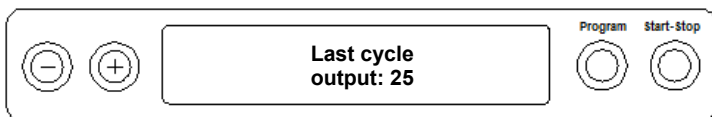

Repeat the last three steps in order to issue further logs.

7. Press the 'S' key to leave the submenu without outputting the log.
8. Press the 'S' key to leave the menu after having outputted the log. The display will show the message **Function: Log output**.
9. Repeated pressing of the 'S' key enables you to leave the menu entirely and return to the display initial state.

Outputting all saved logs

Proceed as follows to output all the saved logs subsequently:

1. Select SETUP menu **Function** by pressing the '+' and '-' keys simultaneously. The display will show the message **Function: Last batch number**
2. Navigate using the '+' or '-' key until the display shows: **Function: Log output** and press the 'P' key.

3. Navigate using the '+' or '-' key until the display shows:

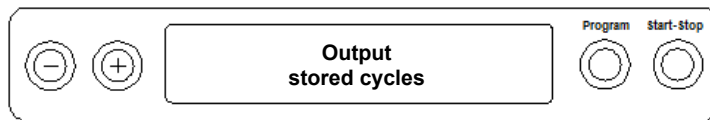

4. Press the 'P' key in order to start the output of the selected program. The display will show the message during the output: **Output**.
 ↳ If output has been performed, the display will show: **Output stored cycles**.
5. Press the 'S' key to leave the submenu without outputting the log.



PLEASE NOTE

An abort during log output on the log printer is only possible through deactivation of the device using the power switch or by interrupting the power supply to the printer.

When switching off the device via the power switch, wait 3 s before switching it back on.

6. Press the 'S' key to leave the menu. The display will show the message of the SETUP menus **Function: Log output**.
7. Repeated pressing of the 'S' key enables you to leave the menu entirely and return to the display initial state.

Displaying the log memory

If a printer or other output medium is connected and initialised, you can check how many logs have already been saved in the steam sterilizer log memory.

Proceed as follows:

1. Select SETUP menu **Function** by pressing the '+' and '-' keys simultaneously. The display will show the message **Function: Last batch number**
2. Navigate using the '+' or '-' key until the display shows: **Function: Log output** and press the 'P' key.
3. Navigate using the '+' or '-' key until the display shows the number of logs saved:

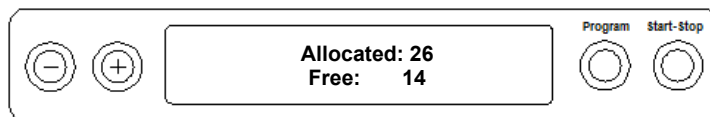

4. Press the 'S' key twice to leave the menu.

Deleting logs in the internal log memory

Delete the saved logs manually to suppress the warning message **Protocol memory full** with the option **Immediate output NO** set. The following example shows how to delete all the logs saved.

1. Select SETUP menu **Function** by pressing the '+' and '-' keys simultaneously. The display will show the message **Function: Last batch number**
2. Navigate using the '+' or '-' key until the display shows: **Function: Log output** and press the 'P' key.
3. Navigate using the '+' or '-' key until the display shows:

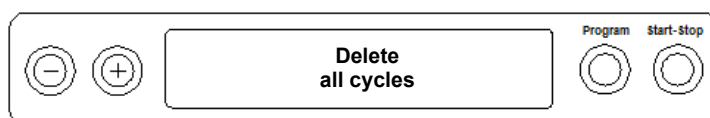

4. Press the 'P' key to delete all logs.

5. To cancel the sub-menu without deleting, press the 'S' key.
6. Press the 'P' key to leave the menu after deletion. The display will show the message **Function: Log output**.
7. Repeated pressing of the 'S' key enables you to leave the menu entirely and return to the display initial state.

Reading logs correctly

Log type	File ending	Explanation
Text log	.PRO	Log of a completed program
Malfunction log	.STR	Log of an unsuccessfully finished program
Graphic log	.GPD	Program run displayed as a graphic curve
Standby log	.STB	Log for faults in standby mode
Demo log	.DEM	Log of a simulated program run. No real sterilization will be performed!
Demo graphic log	.DEG	Simulated program run displayed as a graphic curve. No real sterilization will be performed!

Log header

The header of the program log comprises the general basic information regarding the program run. This includes e.g. date, the selected program, the daily batch number and the device type.

Program step values

The phases of the program run are recorded whilst it runs and the values for steam pressure, temperature and time (related to the program start) are recorded.

Summary

The summary states whether the program has been completed successfully. The values of the sterilization time required, the sterilization temperature and the pressure (including the maximum deviation) are also displayed.

Example for a text log of a successfully completed program

```

MELAG Vacuklav 31-B
-----
Program      : Universal -Program
              134°C wrapped
Date        : 29.08.2018
Time       : 10:39:08 (Start)
Batch number: 3
SN         : 201831-B4321
-----

AIN6: Conductivity 0 µS/cm

Program step  Press.  Temp.  Time
              bar     °C     min

Start                0.00   99.6  00:00
1. Fractionation
  Evacuation        -0.92   49.6  00:45
  Steam intake      0.40  109.2  01:49
2. Fractionation
  Evacuation        -0.82   57.5  02:48
  Steam intake      0.40  109.2  03:47
3. Fractionation
  Evacuation        -0.82   57.5  04:46
  Steam intake      0.40  109.2  05:46
Press. build-up     2.04  134.0  07:05
Steriliz. begin.    2.04  134.0  07:05
Steriliz. end       2.16  135.3  12:35
Press. release      0.12  102.7  14:27
Vacuum-drying
  Drying begin.     -0.30   89.9  14:47
  Drying pressure   -0.98   49.2  16:45
  Drying pressure   -0.99   49.1  18:45
  Drying pressure   -0.98   49.1  20:45
  Drying pressure   -0.99   49.1  22:45
  Drying pressure   -0.98   49.1  24:45
  Drying pressure   -0.99   49.1  26:45
  Drying pressure   -0.98   49.1  28:45
  Drying pressure   -0.99   49.1  30:45
  Drying pressure   -0.98   49.1  32:45
  Drying pressure   -0.99   49.1  34:45
  Drying end        -0.95   49.4  34:47
Ventilate           -0.30   90.0  35:19
End                 0.00   99.6  35:31
-----

PROGRAM SUCCESSFULLY COMPLETED!

Temperature      : 135.3 +0.1 /-0.1 °C
Pressure         : 2.16 +0.01/-0.00 bar
Steril. time     : 5 min 30 s
Time             : 11:14:39 (End)
-----

3 201804321 5.15 5.06

```

Device type

```

-----
Program started
Current date
Time upon program start
Daily batch number
Serial number
-----

```

```

-----
Preheating temperature
Feed water conductivity
-----

```

VALUES OF THE PROGRAM STEPS

```

-----
Program run phases with the appendant values for
pressure, temperature and time (relative to the program
start)
-----

```

SUMMARY - Control message

```

-----
Median sterilization temperature with max. deviations
Median sterilization pressure with max. deviations
Sterilization time maintained
Time upon program end
-----

```

```

-----
Information with total batch counter, factory number and
device software number / version no.
-----

```

9 Function tests

Automatic functional checks

The electronic parameter control subjects the interaction of the sterilization-relevant parameters pressure, temperature and time to constant automatic monitoring. The steam sterilizer process evaluation system compares the process parameters during the program with each other and monitors them in terms of their threshold values. The steam sterilizer monitoring system checks the device components for their functionality and their plausible interaction. Should the parameters exceed pre-set threshold values, the steam sterilizer emits warning or fault messages. If necessary, it interrupts the program with appropriate information. When the program has ended successfully, the corresponding message will be shown on the display.

Manual functional checks

You can follow the program run on the display via the values displayed there. You can also use the log recorded for every program to determine its success, see [Logging](#) [▶ page 31].

Batch-related tests

Test body system MELAcontrol helix and MELAcontrol Pro

The test body system MELAcontrol Helix is an indicator and batch control system fulfilling the requirements of EN 867-5. It consists of a test body and an indicator strip.

When sterilizing category "critical B" instruments, you should add the MELAcontrol Helix or MELAcontrol Pro test body system to every sterilization cycle as a batch control.

Regardless of this, you can perform a steam penetration test in the Universal-Program at any time using MELAcontrol Helix or MELAcontrol Pro.

Intended use of the test body system can result in the colouration of the plastic surface. This colouration exercises no influence on the functionality of the test body system.

Vacuum test

The test detects leaks in the steam sterilizer. This determines the leakage rate at the same time.

Perform a vacuum test in the following circumstances:

- Once a week in routine operation
- During commissioning
- Following longer operating pauses
- In the case of a corresponding malfunction (e.g. in the vacuum system)

Perform the vacuum test with the steam sterilizer in a cold and dry state as follows:

1. Switch on the device at the power switch. The display switches to its initial state.
2. Press the 'P' key until the display shows **Vacuum test**.
3. Close the door.
4. Press the 'S' key to start the vacuum test.

➔ The evacuation pressure and the equilibration time or measurement time are shown on the display. The chamber is ventilated after the end of the measuring time. Then the message will be shown on the display with an indication of the leakage rate. Should the leakage rate be too high i.e. over 1.3 mbar, a corresponding message will be shown on the display.

The current daily batch number and **Acknow. with '+' key** is displayed. You can open the door after pressing the '+' key.

**PLEASE NOTE**

If a log printer or another output medium is connected and the setting **Immediate output YES** is set, a log printout will be issued at the same time.

Bowie & Dick test

The Bowie & Dick test serves as proof of steam penetration of porous materials such as e.g. textiles.

Specialist stockists provide various test systems for the Bowie & Dick test. Perform the test according to the test system manufacturer information.

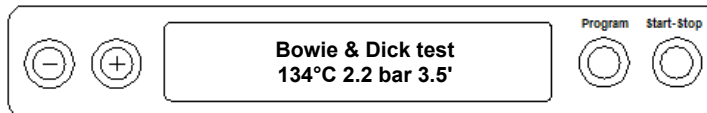

How to start the Bowie & Dick test program:

1. Switch on the device at the power switch.
2. Select the Bowie & Dick test by pressing the 'P' key repeatedly.
3. Press the 'S' key to start the Bowie & Dick test.

Following a successful test program, the current batch number of the day is displayed, alternating with **Ac-know. with '+' key**. You can open the door after pressing the '+' key.

**PLEASE NOTE**

If a log printer or another output medium is connected and the setting **Immediate output YES** is set, a log printout will be issued at the same time.

Evaluation of the indicator following the colour change

Depending on the manufacturer batch, indicators often exhibit differing intensities in the colour change resulting from different lengths of storage or other influences. Of crucial importance for evaluating the Bowie & Dick test is not the strength of contrast in the colour change on the test sheet, but the uniformity of the colour change on the indicator. If the indicator indicates an equal distribution of colour change, the air removal of the sterilization chamber is without fault. If the indicators are uncoloured or exhibit less colour in the centre in comparison to the end, air removal was insufficient. In such a case, please consult the stockist customer services / authorised customer services.

Checking the quality of the feed water

You can access the water quality on the display at any time during a current program when the steam sterilizer is switched on.

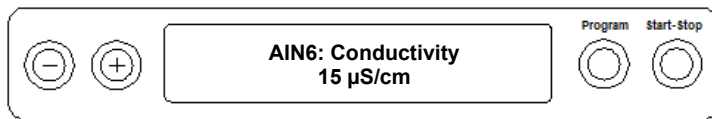

- ▶ To do so, hold the '-' key depressed until the display shows **Conductivity**.
 - ↳ The conductivity is displayed in µS/cm.
- ↳ As soon as you have released the '-' key, the display returns to its previous state (e.g. initial state).

Checking the preheating temperature of the chamber

- ▶ Press the '-' key twice. When pressing the first time, press shortly. When pressing the second time, hold the key depressed.

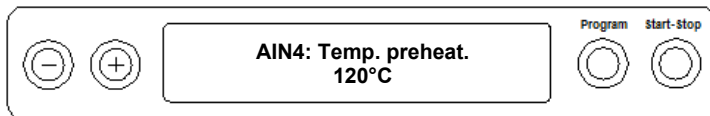

- ↳ The conductivity display disappears and the preheating temperature in the chamber will be displayed.

10 Maintenance

Servicing intervals

Interval	Measure	Device components
Daily	Check for soiling, deposits or damage	Chamber inc. door seal and chamber sealing face, door lock, mount for the load
After 24 months or 1000 cycles	Maintenance	By the authorized customer services working in accordance with the maintenance instructions
As required	Cleaning the surfaces	Housing parts

Cleaning



NOTICE

Inappropriately performed cleaning can lead to the scratching of and damage to surfaces and the development of leaks in sealing surfaces.

This also favours the development of soiling deposits and corrosion in the sterilization chamber.

- Comply with all information regarding cleaning of the part affected.
- Do not use any hard objects for cleaning such as a metal saucepan cleaner or a steel brush.

Sterilization chamber, chamber sealing face, mount, trays

To maintain the value of your device and to avoid persistent contamination and deposits, MELAG recommends weekly cleaning of the surfaces (e.g. with the MELAG chamber cleaning set).

Cleaning the sterilization chamber, chamber sealing face, mount and trays

The following must be fulfilled or present:

- ✓ *The device has been switched off and the power plug has been unplugged from the socket.*
- ✓ *The device has been completely cooled.*
- ✓ *Trays or sterilization containers and the associated mount have been removed from the sterilization chamber.*

1. Wet the surfaces to be cleaned completely with the cleaning fluid.
Please note: You should not allow cleaning fluid to enter the piping coming from the sterilization chamber.
2. Spread the cleaning fluid evenly with a non-fuzzing cloth.
3. Allow the cleaning fluid to act and evaporate for a sufficient time.
4. Using a new non-fuzzing cloth, spread ample amounts of demineralised water over the cleaned surfaces.
5. Wipe the surfaces thoroughly to remove cleaning residues. Repeat this process as necessary after wringing out the cloth.
↳ Residues of cleaning fluids can ignite or cause deposits on the instruments.
6. Allow the cleaned areas to dry completely. This may take a few minutes.
7. Finally, wipe the cleaned surfaces with a dry, non-fuzzing microfibre cloth.

Housing parts

Where necessary, clean the housing parts with a neutral fluid cleaner or spirit.

Internal storage tank

Should you use the internal storage tank for the feed water supply, perform regular checks and cleaning.

Interval	Measure
Each time you fill up	Check the storage tank for soiling. If necessary, clean the storage tank before filling.
Weekly	Replace the feed water completely.
Every 2 weeks	Clean the drain side of the storage tank.

Empty the storage tank

1. Open the device door.
2. Connect the drain hose to the bleed valve for feed water or wastewater. Turn the bleed valve with the drain hose anti-clockwise as far as it will go.

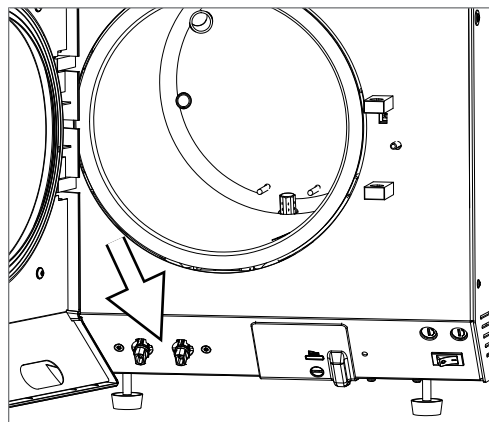

3. Discharge the water into a container with min. volume of 5 l.
4. Turn the bleed valve with the drain hose anti-clockwise as far as it will go.
 ↳ The bleed valve is closed.
5. Remove the drain hose by pulling it lightly backwards away from the device.

Clean the supply and wastewater side

✓ *The device has been completely cooled.*

1. Remove the tank lid and the feed funnel.
2. Clean the feed water side (right) and wastewater side (left) with a lint-free cloth and fresh feed water.
3. Return the filling funnel and the tank lid.

Avoiding staining

Only proper cleaning of the instruments prior to sterilization enables you to avoid residue from being released from the load under steam pressure during sterilization. Loosened dirt residue can clog the filter, fittings and valves of the device and deposit themselves on the instruments and in the sterilization chamber as deposits and stains.

All steam-conducting parts of the device consist of non-rusting material. This rules out the possibility of stain or rust development being caused by the steam sterilizer. Any rust which develops is always extraneous rust.

Incorrect instrument decontamination can result in the accretion of rust even on stainless steel instruments of leading manufacturers. Often, a single instrument which drops rust can suffice to cause the development of rust on other instruments or in the device. Remove foreign rust from the instruments using chlorine-free stainless steel cleaning fluid (see [Cleaning](#) ► page 42]) or send the damaged instruments to the manufacturer.

The extent of stain accretion on the instruments is also dependant on the feed water used for steam generation.

Replacing the door seal

The door seal may not be greased or oiled. It should be kept clean and dry. If the door seal becomes worn or loses form, it must be replaced. Otherwise, this could result in leaks which will enable steam egress, or can cause too high a leakage rate in the vacuum test. The door seal is only inserted in the groove of the round blank and can be changed as follows:

1. Open the steam sterilizer door and remove the old door seal.



2. Insert the door seal in the groove of the round blank.



PLEASE NOTE

Make sure that the broad seal face faces the sterilization chamber when inserting. The door can only be shut correctly and the sterilization chamber sealed, if the door seal sits correctly in the groove.

Replacing or sterilizing the sterile filter

The sterile filter must be replaced regularly within the scope of the maintenance. In the event of malfunctions and the fault message F32: **Power failure/Sterilize sterile filter** replace or sterilize the sterile filter.



NOTICE

Only ever operate the steam sterilizer with a sterile filter inserted.

Replacing the sterile filter

1. Remove the sterile filter by turning and pulling it from the holding sockets simultaneously.

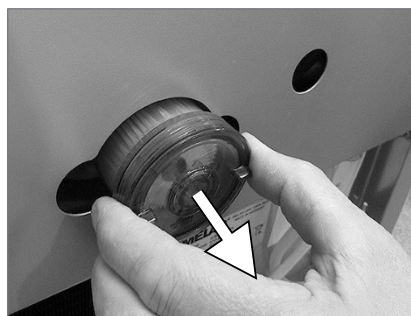

2. Replace the sterile filter or sterilize the current sterile filter, see [Sterilizing the sterile filter](#) [▶ page 46].

3. Exert a little pressure on the sterile filter and turn to insert it into the holding sockets.

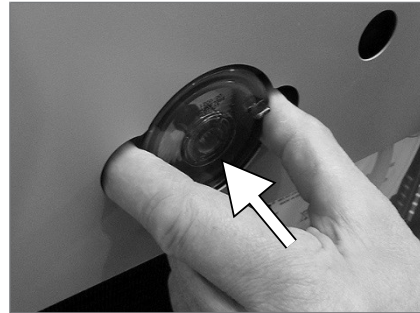

Sterilizing the sterile filter

1. Remove the sterile filter by turning and pulling it from the holding sockets simultaneously.

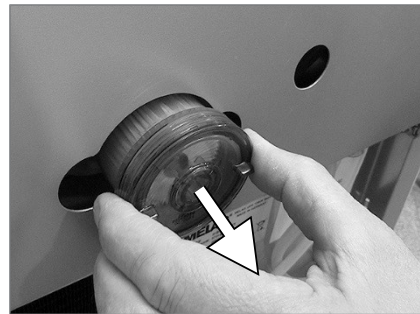

2. Slide it into the steam sterilizer and place the sterile filter vertically on the tray. Ensure that the sterile filter does not fall over, otherwise the condensate will not be able to drain away correctly.



3. Start the **Gentle-Program**.
4. Remove the sterile filter from the device after the program end and allow it to cool for min. 15 min.
5. Exert a little pressure on the sterile filter and turn to insert it into the holding sockets.

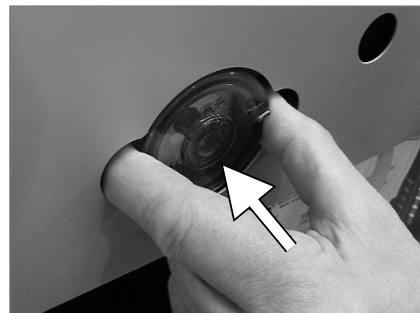

Cleaning the filter in the chamber

1. Screw out the condensate return filter (pos. a) and the chamber filter (pos. b) anti-clockwise from the opening in order to perform a check.

Unscrew the chamber filter (pos. b) using the chamber filter wrench included in the scope of delivery (pos. c).

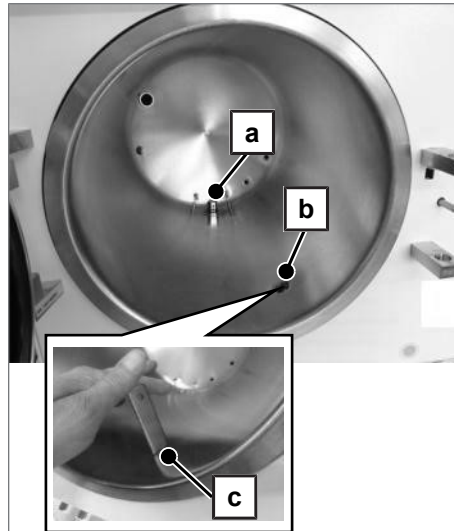

2. Rinse the filter (pos. a and b) for cleaning with water.
3. Screw in the condensate return filter (pos. a) and the chamber filter (pos. b) clockwise into the opening.

Maintenance



NOTICE

Continuing operation beyond the maintenance interval can result in malfunctions in the device.

- Maintenance should only be performed by trained and authorized service technicians or stockist technicians.
- Maintain the specified servicing intervals.

Regular maintenance is vital to ensure reliable operation and value retention of the steam sterilizer. All function and safety-relevant components and electrical units must be checked during maintenance and replaced where necessary. Maintenance is performed in accordance with the maintenance instructions pertinent to this steam sterilizer.

Arrange for regular maintenance in 24 month intervals or after 1000 program cycles. The steam sterilizer will issue a maintenance message at the relevant time.

11 Pause times

Frequency of sterilization

Pause times between individual programs are not necessary. After the end/abort of the drying time and removal of the sterile material, you can load the steam sterilizer again and start a new program.

Operating pauses

Depending on the duration of the operating pauses, the following measures must be maintained:

Duration of the operating pause	Measure
Short pauses between two sterilization processes	<ul style="list-style-type: none"> ▪ Keep the door closed to save energy
Pauses which last longer than an hour	<ul style="list-style-type: none"> ▪ Switch off the steam sterilizer
Longer pauses e.g. over night or the weekend	<ul style="list-style-type: none"> ▪ Switch off the steam sterilizer ▪ Leave the door ajar to prevent premature wear and the sticking of the door seal ▪ If present, shut off the water inflow of the water treatment unit
Longer than two weeks	<ul style="list-style-type: none"> ▪ Switch off the steam sterilizer ▪ Leave the door ajar to prevent premature wear and the sticking of the door seal ▪ If present, shut off the water inflow of the water treatment unit <p>Upon re-commissioning:</p> <ul style="list-style-type: none"> ▪ Perform a vacuum test ▪ After a successful vacuum test, perform an empty sterilization run in Quick-Program B

After pauses, perform the checks described in chapter [Function tests](#) [▶ page 39] depending on the length of pause.

Decommissioning

When decommissioning the steam sterilizer for a long pause (e.g. due to holiday or planned transport), proceed as follows:

1. Empty the storage tank, see [Internal storage tank](#) [▶ page 43].
2. Switch off the device at the power switch.
3. Disconnect the power plug from the socket.
4. Clean the supply tank, see [Internal storage tank](#) [▶ page 43].
5. Close the water inflow if you are using a water treatment unit.

Transport

Transport within the practice

**NOTICE**

Failure to observe these provisions can result in damage to the device and malfunction.

Comply with the following provisions when transporting within a room or the practice:

- ▶ Empty the feed and wastewater side of the internal storage tank, see [Internal storage tank](#) [▶ page 43].
- ▶ When using a water treatment unit and/or an outlet hose, close the water inflow and remove the hose connections on the rear of the device.
- ▶ Should you wish to leave the mount and trays or sterilization containers in the sterilization chamber during transport, protect the surface of the round blank. To do so, place e.g. some foam or bubble wrap between the round blank and mount.
- ▶ Close the device door before moving the device.

Transport over long distances

**NOTICE**

Damage to the housing and the device interior as a result of using unsuitable transport packaging.

- Only transport the device in its original packaging or other suitable packaging.
-

Comply with the following provisions when transporting the steam sterilizer (e.g. a move or dispatch):

- ▶ Before transporting the steam sterilizer over long distances, before dispatch or given the danger of frost, an authorized technician must prepare the device in accordance with the instructions and empty the storage tank entirely.

Recommissioning after relocation

When recommissioning after a move, proceed as with the first commissioning; see the technical manual.

12 System malfunctions

Troubleshooting online

All messages with current descriptions can be found in the Troubleshooting portal on the MELAG website (<https://www.melag.com/en/service/troubleshooting>).



Warnings

Warning messages are not fault messages. They help to ensure malfunction-free operation and to recognise undesirable situations. Comply with these warning messages early in order to avoid malfunctions.

Fault messages

Fault messages are issued on the display with an event number. This number serves identification purposes. Fault messages are issued when it is not possible to ensure safe operation or safety of sterilization. These can appear on the display shortly after activating the steam sterilizer or during a program run.

If a malfunction occurs during a program run, the program will be aborted.



WARNING

Danger of infection from early program abort

Aborting a program before the drying phase begins means that the load is unsterile. This endangers the health of your patients and practice team.

- Re-pack the load if necessary.
- Repeat the sterilization of the load.

Before contacting customer services

Ensure that you have complied with all instructions relating to a warning or fault message issued by the display of the device. The following table contains a summary of the most important events. The events contain possible causes and the corresponding operator information.

Should the following table not contain the relevant event, or your efforts do not redress the problem, you can contact your nearest stockist or a local authorised MELAG customer service provider. Please have the serial number of your device and a detailed description of the message ready.

Information messages

Event	Possible causes	What you can do
Empty display	Insufficient power supply.	<p>Check the power plug for its correct position in the socket.</p> <p>Check the mains voltage at the socket.</p> <p>If necessary, replace the device fuses on the lower front the steam sterilizer, see Replacing the device fuses [▶ page 62].</p>
Door cannot be opened	The door seal sticks to the seal face.	<ol style="list-style-type: none"> 1. Switch on the steam sterilizer. 2. Press the '+' key to open the door and pull strongly on the door in order to open it.
Feed water consumption too high	The steam sterilizer has been loaded incorrectly.	Comply with the load quantities, see Loading the steam sterilizer [▶ page 23].
	The steam sterilizer has not been set-up correctly.	Check that the steam sterilizer is set up correctly. If necessary, increase the slope of the device feet by unscrewing them by max. two revolutions.
	Condensate reflux is prevented.	Remove any instruments, filter paper or other objects which have fallen onto the chamber floor.
Poor drying results	The steam sterilizer has been loaded incorrectly.	Comply with the load quantities, see Loading the steam sterilizer [▶ page 23]. The textiles may not be permitted to have direct contact with the chamber wall and floor.
	The steam sterilizer has not been set-up correctly.	Check that the steam sterilizer is set up correctly. If necessary, increase the slope of the device feet by unscrewing them by max. two revolutions.
	Condensate return is prevented or blocked.	<ol style="list-style-type: none"> 1. Remove any instruments, filter paper or other objects which have fallen onto the chamber floor. 2. Check the chamber filter and "condensate return" filter for blockage. 3. Select automatic preheating, see Selecting automatic preheating [▶ page 26]. 4. Activate additional drying, see Selecting additional drying [▶ page 26].

Warnings

Event	Possible causes	What you can do
Notice: no feed water / refill feed water – start not possible	There is insufficient feed water in the internal storage tank.	Check the water level of the feed water in the internal storage tank and refill with feed water if necessary.
Notice: no feed water / check the feed water inflow	When using the internal storage tank:	
	The warning message will be displayed after a program start. The installed flow monitor does not close.	Upon repeated incidence, contact an authorised customer services / stockist technician.
	When using a MELAG water treatment unit:	
	The warning message will be displayed after a program start. The installed flow monitor does not close.	<p>MELAdem 40/53/53 C: Check the water treatment unit and open the inflow to the system if necessary. Upon repeated incidence, contact an authorised customer services / stockist technician.</p> <p>MELAdem 47: Check the water treatment unit and if necessary, open the inflow to the system. Perform a new start with an empty pressure storage after approx. 1 hour. Upon repeated incidence, contact an authorised customer services / stockist technician.</p> <p>PLEASE NOTE: This message can be issued following commissioning/ recommissioning, as the pipe system has not been filled completely. Repeat the start.</p>
Poor feed water / replace the cartridge or module	The conductivity of the feed water is too high. Conductivity $\geq 40 \mu\text{S/cm}$	Start through repeated pressing of the 'S' key still possible.
	When using a MELAG water treatment unit:	
	The mixed-bed resin is exhausted.	MELAdem 40/53/53 C: Replace the mixed-bed resin (art. no. ME 61026), see the operating manual of the MELAdem 40 water treatment unit.
	The mixed-bed resin in the ion exchanger (3rd cartridge) is exhausted.	<p>MELAdem 47: Replace the mixed-bed resin (art. no. ME 37470), see the operating manual of the MELAdem 47 water treatment unit and check the treatment unit.</p> <p>Following repeated incidence, arrange for maintenance to be performed by the authorised customer services / stockist technician. The pre-filter and activated carbon filter may require changing.</p>
	When using a different water treatment unit:	
The mixed-bed resin in the reverse osmosis unit is exhausted.	<p>Replace the module / resin cartridge in accordance with the manufacturer's operating manual. Maintenance is required following repeated incidence.</p> <p>PLEASE NOTE: Perform a program start after completing the work outlined above. This warning message can be issued upon the initial start after maintenance of the water treatment unit, as the inflow hose / the measurement cell have not been completely rinsed with fresh water.</p>	

Event	Possible causes	What you can do
Feed water quality insufficient/No start possible	Feed water conductivity too high. Conductivity $\geq 65 \mu\text{S/cm}$	Start no longer possible. See event: Feed water quality poor/ Exchange cartridge/ module.
Please wait, the chamber is warming	This message appears during the program start phase. The steam sterilizer has not yet reached the starting temperature.	The steam sterilizer starts automatically after the starting temperature has been reached.
Notice: change the sterile filter	The min./max. pressure is exceeded/undercut during air drying; the sterile filter is soiled or torn.	Replace the sterile filter. PLEASE NOTE: The message is issued at the end of the program and in the last line of the log output.
Output medium is not ready	The steam sterilizer is operating without an output medium, but one has been registered.	Working in the Log output menu, set the option No output medium .
	The output medium has not been connected properly.	Check that the data cable has been connected to the steam sterilizer and output medium correctly.
	The electricity supply to the printer has been interrupted.	Make sure that the power supply is connected. The red LED "P" on the MELAprint 42/44 log printer must illuminate red.
	The printer is offline.	Set the printer online (press the 'SEL' key on MELAprint 42/44, the "SEL" LED must illuminate green).
Log memory full	The internal log memory of the device is full (max. 40 logs possible).	The message is displayed upon program start. Repeated pressing of the 'S' key removes the message and the program starts. The oldest log will be deleted in the process.
	An output medium has been registered. In the Log output menu, the option Immediate output NO has been set.	<ol style="list-style-type: none"> 1. Set the steam sterilizer to Immediate output YES, see Outputting logs immediately and automatically [▶ page 34]. 2. Delete the internal device memory, see Deleting logs in the internal log memory [▶ page 36]. If necessary, output all previously saved logs, see Subsequent log output [▶ page 35]. 3. Working in the Log output menu, deselect the output medium and set the option No output medium.
Carry out maintenance	The maintenance message is activated. The device has reached 1000 cycles or the running time of 24 months.	The message is displayed upon every program start. Repeated pressing of the 'S' key removes the message and the program starts. Retain the message: Press the 'S' key twice to start. Arrange for maintenance by the authorised customer services / stockist technician. PLEASE NOTE: The maintenance counter is reset by the customer services.

Event	Possible causes	What you can do
Test unsuccessful Leakage rate: 3.2	The leakage rate determined during the vacuum test lies over the maximum permissible value of 1.3 mbar. The door seal and / or chamber seal face is soiled.	<ol style="list-style-type: none"> 1. Check the door seal and the flange of the sterilization chamber for soiling and clean if necessary. 2. Check the door seal for damage and change if necessary, see Replacing the door seal [▶ page 44]. 3. Repeat the vacuum test with a cold device, see Vacuum test [▶ page 39].
	The door seal has been inserted incorrectly.	<ol style="list-style-type: none"> 1. Check the door seal for its correct position. 2. Repeat the vacuum test with a cold device, see Vacuum test [▶ page 39].
Notice! Battery empty	Monitoring of the internal battery voltage has returned a low value.	The battery is to be replaced by the authorized customer services/stockist technician.

Malfunction messages

Event	Possible causes	What you can do
F01	The door seal and/or the chamber seal face is soiled or the door seal is defective.	Check the door seal and the chamber seal face for soiling and foreign bodies and clean them if necessary. Check the door seal for defects and replace if necessary, see Replacing the door seal [▶ page 44].
	The door seal was not inserted correctly.	Check whether the door seal has been inserted correctly, see Replacing the door seal [▶ page 44]. Insert the new door seal in the groove in such a way that the wider seal face points towards the side of the sterilization chamber.
	The sterilization chamber is too hot or too damp.	Allow the steam sterilizer to cool and rub the sterilization chamber dry with a non-fuzzing cloth. PLEASE NOTE: The sterilization chamber must be dry and cold to ensure a successful vacuum test.
	The incline to the steam sterilizer is too flat.	Check the incline of the steam sterilizer to the rear. Complete condensate drainage from the sterilization chamber is only possible with a sufficient rearwards incline. Starting with the device in a level position, the fore device feet are to be extended to the following extent: Vacuklav 23 B+: min five rotations, Vacuklav 31 B+: three rotations.
	The condensate is not able to flow out of the sterilization chamber to the rear.	Unscrew and remove the "Condensate return filter" and "Vacuum" chamber filters (directly under the floor of the sterilization chamber at the rear and the front) and check whether they are soiled/blocked. Clean the filter if necessary, see Cleaning the filter in the chamber [▶ page 47].
	The surrounding temperature of the steam sterilizer is too hot.	The ambient temperature must amount to < 40 °C. We recommend a maximum temperature of 25 °C.
	The minimum clearance to the surrounding surfaces has not been maintained.	Maintain a minimum clearance to the surrounding surfaces (see information in the technical manual). The device may only be installed if sufficient ventilation can be guaranteed.
	The outlet opening of the evaporator coil in the wastewater side (left) of the internal storage tank is impeded.	Check the outlet opening of the evaporator coil as follows: <ol style="list-style-type: none"> 1. Remove the tank lid from the internal storage tank. 2. Remove the filling funnel if present. 3. Check whether the outlet opening of the evaporator coil at the front underneath the tank lid is blocked or the rubber panel obscures the opening.

Event	Possible causes	What you can do
F02	The steam sterilizer is overloaded.	Comply with the maximum permissible load quantities, see Loading the steam sterilizer [▶ page 23].
	The incline to the steam sterilizer is too flat.	Check the incline of the steam sterilizer to the rear. Complete condensate drainage from the sterilization chamber is only possible with a sufficient rearwards incline. Starting with the device in a level position, the fore device feet are to be extended to the following extent: Vacuklav 23 B+: min five rotations, Vacuklav 31 B+: three rotations.
	The mains voltage is too low, poor building voltage supply (e.g. undersized installation, defective socket, multiple devices on a single socket/fuse) so that the steam generator cannot heat up.	Check the building-side socket / test the steam sterilizer using a different socket or circuit.
F04	The “condensate return” filter is blocked.	Screw out the “Condensate return” filter (in the rear area of the chamber floor) and check whether it is soiled/blocked. Clean the filter if necessary, see Cleaning the filter in the chamber [▶ page 47].
F06	The sterile filter is blocked.	<ol style="list-style-type: none"> 1. Check whether the sterile filter suction aperture (centre aperture) on the rear panel of the steam sterilizer is blocked. If yes, replace it with a new sterile filter, see Replacing or sterilizing the sterile filter [▶ page 45]. 2. If nothing can be recognised, remove the sterile filter on the rear panel of the steam sterilizer and perform a program run without a load. If the program has been ended successfully, the sterile filter is blocked. In this case, replace the sterile filter.
F08	The internal device time monitoring is defective.	Check the building-side socket / test the steam sterilizer using a different socket or circuit or connect to a mains filter. Upon repeated incidence, arrange for an electrician to check the electricity supply for electromagnetic disruption.
F09	The door has not been closed correctly upon program start.	Close the door correctly and start the program again. PLEASE NOTE: To shut the door correctly, press it against the steam sterilizer lightly and slide the slide locking grip downwards to its fullest extent.
	An attempt was made to open the door during a program run.	Do not attempt to open the door during a program run.
F10	The overheat protection of the steam generator has triggered.	Allow the steam sterilizer to cool for approx. 2 min and then restart the program. PLEASE NOTE: This message can be issued if a program is started immediately after a malfunction or a program abort.
F12	The door has not been closed correctly.	To shut the door correctly, press it against the steam sterilizer lightly and slide the slide locking grip downwards to its fullest extent.
	The locking pin for the door is stiff.	Open the door, switch off the steam sterilizer and press in the locking pin by hand. The pin must be free-moving. If necessary, clean the locking pin.

Event	Possible causes	What you can do
F14	When using the internal storage tank:	
	There is not enough feed water in the feed water side (right).	Check the feed water level in the feed water side (right) and refill with feed water if necessary.
	Residual air in the feed system after filling the storage tanks.	Acknowledge the fault message and start the program repeatedly until the fault message is no longer displayed.
	If the message is displayed despite a full tank, the float switch is blocked.	<ol style="list-style-type: none"> 1. Remove the tank lid from the storage tank. 2. Remove the filling funnel if present. 3. Move the float in the feed water side (at the front bottom of the tank) up and down several times to make it move smoothly again.
	When using a MELAG water treatment unit:	
	Residual air is in the feed system of the water treatment unit after initial commissioning or after replacing the mixed-bed resin cartridge.	Acknowledge the fault message and start the program repeatedly until the fault message is no longer displayed.
	The pressure tank of the MELAdem 47 is not sufficiently filled.	Please note that after initial commissioning of a MELAdem 47 it takes approx. 1 h until the pressure tank is sufficiently full with water.
	The water inflow tap is not open or the pressure tank of the MELAdem 47 is closed.	Check whether the water inflow tap for the water treatment unit is open. When using a MELAdem 47, also check whether the tap on the pressure tank is open.
When using a central water treatment unit:		
The central water supply has been interrupted or the flow pressure is insufficient.	Check whether all inflow valves from the central system to the steam sterilizer are open. If necessary, arrange for an inspection of the flow pressure of the central water treatment unit using a flow pressure gauge (min. 0.5 bar at 5 l/min).	
F18	Malfunction on the specified sensor input	Upon repeated incidence, contact an authorised customer services / stockist technician.
	With "Malfunction 18 Sensor: 6 Input: 6" an excessively high conductivity of the feed water supply can be measured.	Check whether the water used as feed water actually corresponds to the required quality or e.g. tap water has been used. The feed water must fulfil the quality requirements of EN 13060, Appendix C. If tap water has been used, restart the steam sterilizer two to three times so as to flush out the tap water from the system.

Event	Possible causes	What you can do
F25	The quality of the feed water is very poor (conductivity $\geq 65 \mu\text{S/cm}$).	
	When using the internal storage tank:	
	Water of insufficient quality e.g. tap water was used.	Drain and clean the feed water side (right) and fill it with water of required quality (EN 13060, Appendix C).
	When using a MELAG water treatment unit:	
MELAdem 40: The mixed-bed resin cartridge is exhausted.	MELAdem 40/53/53 C: Replace the MELAdem 40 mixed-bed resin cartridge in accordance with the applicable operating manual.	
MELAdem 47/53: The mixed-bed resin cartridge, the pre-filter or the activated coal filter is exhausted.	MELAdem 47: Replace the mixed-bed resin cartridge and if necessary, the pre-filter and activated carbon filter of the MELAdem 47 in accordance with the applicable operating manual. Empty the pressure tank (if possible until it is half full) and wait until it has been filled again. An empty pressure tank requires approx. one hour to fill. PLEASE NOTE: The message may also continue to be shown after the filter has been changed until the water remaining in the pressure tank has been consumed.	
F28	Insufficient battery voltage in the device.	Arrange for the battery to be replaced by customer services / stockist customer services.
F29	Data loss in the internal device memory. Insufficient voltage of the device battery.	1. Acknowledge the fault message and then reset the date and time, see Setting the date and time [▶ page 19]. 2. Start the program again.
F31	During the vacuum test, the permissible maximum pressure was exceeded after the evacuation pressure had been achieved (serious leak). The sterilization chamber is too hot or too damp.	Allow the steam sterilizer to cool and rub the sterilization chamber dry with a non-fuzzing cloth. PLEASE NOTE: The sterilization chamber must be dry and cold to ensure a successful vacuum test.
	The door seal and/or the chamber seal face is soiled or the door seal is defective.	Check the door seal and the chamber seal face for soiling and foreign bodies and clean them if necessary. Check the door seal for defects and replace if necessary, see Replacing the door seal [▶ page 44].
	The door seal was not inserted correctly.	Check whether the door seal has been inserted correctly, see Replacing the door seal [▶ page 44]. Insert the new door seal in the groove in such a way that the wider seal face points towards the side of the sterilization chamber.

Event	Possible causes	What you can do
F32	The steam sterilizer was switched off at the power switch during a program run.	<p>Replace or sterilize the sterile filter as follows:</p> <ol style="list-style-type: none"> 1. Remove the sterile filter from the rear panel of the steam sterilizer and sterilize it in the Gentle-Program without continuing loading. 2. Return the sterile filter to the rear panel. <p>Never switch off the steam sterilizer at the power switch during a program run. Always abort a program with the 'Start-Stop' key.</p>
	The power plug has been disconnected or has not been connected correctly in the socket.	Check whether the power plug is connected, the power cable has suffered damage, or a loose contact or loose plug connections is the cause. Plug the power plug back into the mains socket.
	Power failure in the building supply.	Arrange for an inspection of the building-side installation (e.g. automatic circuit breaker) and test the steam sterilizer at another socket or on another circuit.
F34	The sterilization temperature on temperature sensor 1 was undercut. The steam sterilizer is overloaded.	Comply with the maximum permissible load quantities, see Loading the steam sterilizer [▶ page 23]. If necessary, perform a vacuum test, see Vacuum test [▶ page 39].
	The door seal and/or the chamber seal face is soiled or the door seal is defective.	Check the door seal and the chamber seal face for soiling and foreign bodies and clean them if necessary. Check the door seal for defects and replace if necessary, see Replacing the door seal [▶ page 44].
	The door seal was not inserted correctly.	Check whether the door seal has been inserted correctly, see Replacing the door seal [▶ page 44]. Insert the new door seal in the groove in such a way that the wider seal face points towards the side of the sterilization chamber.
F36	The required chamber pressure was undercut during sterilization. The steam sterilizer is overloaded.	Comply with the maximum permissible load quantities, see Loading the steam sterilizer [▶ page 23]. If necessary, perform a vacuum test, see Vacuum test [▶ page 39].
	The door seal and/or the chamber seal face is soiled or the door seal is defective.	Check the door seal and the chamber seal face for soiling and foreign bodies and clean them if necessary. Check the door seal for defects and replace if necessary, see Replacing the door seal [▶ page 44].
	The door seal was not inserted correctly.	Check whether the door seal has been inserted correctly, see Replacing the door seal [▶ page 44]. Insert the new door seal in the groove in such a way that the wider seal face points towards the side of the sterilization chamber.
F39	The internal memory (EEPROM) has suffered data inconsistency or data loss.	<ol style="list-style-type: none"> 1. Acknowledge the fault message and then reset the date and time, see Setting the date and time [▶ page 19]. 2. Start the program again.
F40	There is not enough feed water in the feed water side (right).	Check the feed water level in the feed water side (right) and refill with feed water if necessary.
	If the message is displayed despite a full tank, the float switch is blocked.	<ol style="list-style-type: none"> 1. Remove the tank lid from the storage tank. 2. Remove the filling funnel if present. 3. Move the float up and down in the feed water side (at the front bottom of the tank).

Event	Possible causes	What you can do
F47	The left chamber of the wastewater side (left) is full.	Empty the wastewater side (left).
	If the message is displayed despite an empty tank, the float switch is blocked.	<ol style="list-style-type: none"> 1. Remove the tank lid from the storage tank. 2. Remove the filling funnel if present. 3. Move the float in the feed water side (at the front bottom of the tank) up and down several times to make it move smoothly again.
F48	Parameter malfunction	<ol style="list-style-type: none"> 1. Switch off the steam sterilizer and back on again. 2. Restart the program.
F51	The sterilization temperature on temperature sensor 2 was undercut. The steam sterilizer is overloaded.	Comply with the maximum permissible load quantities, see Loading the steam sterilizer [▶ page 23]. If necessary, perform a vacuum test, see Vacuum test [▶ page 39].
	The door seal and/or the chamber seal face is soiled or the door seal is defective.	Check the door seal and the chamber seal face for soiling and foreign bodies and clean them if necessary. Check the door seal for defects and replace if necessary, see Replacing the door seal [▶ page 44].
	The door seal was not inserted correctly.	Check whether the door seal has been inserted correctly, see Replacing the door seal [▶ page 44]. Insert the new door seal in the groove in such a way that the wider seal face points towards the side of the sterilization chamber.

Opening the door in an emergency following a power outage



WARNING

The steam sterilizer must be completely pressure free.

Failure to observe this provision can result in scalding / injury.

- No steam may be permitted to leave from between the sterile filter and the rear panel of the steam sterilizer.
- The slide seal grip must be easy to actuate.
- It must be possible to push the door approx. 2 mm to the rear with light pressure.
- It is imperative that you allow the steam sterilizer to cool. Metal parts such as the door and chamber can be hot.

If the door cannot be opened, e.g. due to a power failure, please proceed as follows, observing the safety information provided above:

1. Switch off the steam sterilizer at the mains and remove the plug from the socket.
2. Position long side of the lever between the door and the side wall of the steam sterilizer. The curve points forwards and the lever is at the level of the slide locking grip.

If the lever is in the guide, pull it forwards with your right hand. Push the slide locking grip upwards with your other hand.

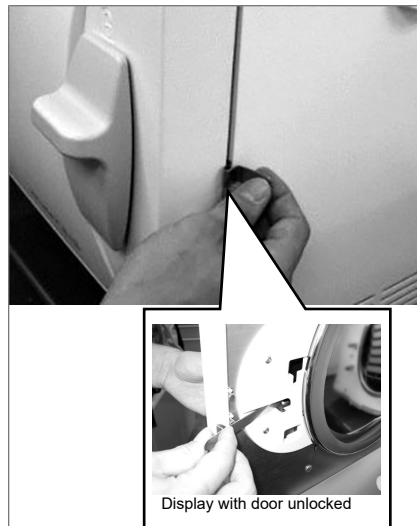

3. Open the door.

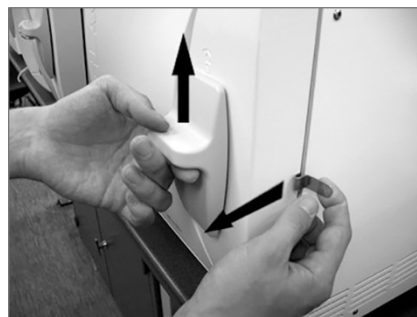

Replacing the device fuses

If the device fuses have tripped, proceed as follows to replace them:

1. Switch off the steam sterilizer at the mains and remove the plug from the socket.
2. Open the door manually, see [Emergency door opening in case of power failure](#) [▶ page 61].
3. Unscrew and remove both caps on the fuse holder on the lower front of the steam sterilizer with a screwdriver or coin.

Two replacement fuses are mounted on the inside of the door (see marking).

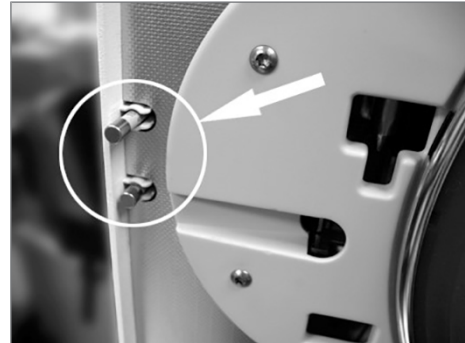

4. Remove the defective fuses and insert the new fuses securely in their holder.



5. Screw the cap of the fuse holder to the lower front of the steam sterilizer.
6. Reconnect the steam sterilizer plug to the socket and switch on the steam sterilizer at the power switch.

Should this trigger repeatedly, inform the authorised customer services / stockist technician.

13 Technical data

Device type	Vacuklav 23 B+	Vacuklav 31 B+
Device dimensions (H x W x D)	49 x 42.5 x 74 cm	49 x 42.5 x 62 cm
Empty weight	50 kg	45 kg
Operating weight	62 kg	57 kg
Sterilization chamber		
Diameter	25 cm	
Depth	45 cm	35 cm
Volume	22.6 l	17 l
Electrical connection		
Electricity supply	220-240 V, 50/60 Hz	
Max. voltage range	207-253 V	
Electrical power	2100 W	
Building fuses	separate power circuit with 16 A fuse, 30 mA RCD protection	
Overvoltage category	transient overvoltage up to the values of overvoltage category II	
Degree of air pollution (acc. to EN 61010-1)	category 2	
Length of power cable	1.35 m	
Ambient conditions		
Installation location	interior of a building	
Noise emission	65 dB(A)	
Waste heat (with max. load)	0.9 kWh	
Ambient temperature	5-40 °C (recommended max. 25 °C)	
Relative humidity	max. 80 % at 31 °C, decreases in a linear fashion up to max. 50 % relative humidity at 40 °C	
Degree of protection (acc. to IEC 60529)	IP20	
Max. altitude	2000 m	
Feed water connection		
Water quality	distilled or demineralised feed water in accordance with EN 13060, Appendix C (with central demineralisation system max. conductivity 5 µS/cm)	
Recommended flow pressure	1.5 bar at 3 l/min	
Min. water pressure (static)	corresponding to the water treatment unit ⁴⁾	
Max. water pressure (static)	10 bar	
Max. water consumption ⁵⁾	approx. 700 ml	
Min. filling volume (internal storage tank, feed water side)	1 l	
Volume (internal storage tank, feed water side)	4 l (approx. 7 cycles)	
Wastewater connection		
Max. water temperature	70 °C ⁶⁾	
Volume (internal storage tank, wastewater side)	3 l	

⁴⁾ Optional when using a water treatment unit

⁵⁾ In the Prion program with porous full load.

⁶⁾ Optional: automatically via the one-way drain with the MELAG upgrade kit for the tank drain

14 Accessories and spare parts

You can obtain the specified articles and an overview of further accessories from your stockist.

Category	Article	Art. no.	
		Chamber depth 45 cm	Chamber depth 35 cm
Mounts	Mount A Plus for 5 trays or 3 MELAstore Boxes 100	ME82630	ME82620
	Mount D for 2 tall sterilization containers or 4 trays	ME46840	
Sterilization container with disposable paper filters in accordance with EN 868-8 (depth x width x height)	15K (18 x 12 x 4.5 cm)	ME01151	
	15M (35 x 12 x 4.5 cm)	ME01152	
	15G (35 x 12 x 8 cm)	ME01153	
	17K (20 x 14 x 5 cm)	ME01171	
	17M (41 x 14 x 5 cm)	ME01172	--
	17G (41 x 14 x 9 cm)	ME01173	--
	23M (42 x 16 x 6 cm)	ME01231	--
	23G (42 x 16 x 12 cm)	ME01232	--
	28M (32 x 16 x 6 cm)	ME01284	
	28G (32 x 16 x 12 cm)	ME01285	
Package holder	Package holder (Ø 25 cm)	ME22420	ME22410
Trays	Tray	ME00230	ME00280
Test body system	MELAcontrol Helix consisting of a Helix test body and 250 indicator strips	ME01080	
	MELAcontrol Pro consisting of a Helix test body and 40 indicator strips	ME01075	
Water treatment unit	MELAdem 40 ion exchanger	ME01049	
	MELAdem 47 reverse osmosis unit	ME01047	
	MELAjet spray pistol	ME27300	
For the documentation	MELAflash CF card printer including MELAflash CF card and card reader	ME01039	
	MELAnet Box	ME40296	
	MELAprint 44 log printer	ME01144	
Other	Chamber cleaning set	ME01081	
Spare parts	Water stop	ME01056	
	Device fuses 20 A gRL	ME57589	
	Door seal	ME58512	
	Sterile filter	ME20160	
	Slide clips for mounts Plus, 10 pcs.	ME81235	

Glossary

Air leakage

is a location through which air can pass in and out without this being desired. Verification of the leakage serves to prove that the volume of air ingress in the chamber during the vacuum phase does not exceed a value which would prevent steam penetration of the sterilizer load and that the air leakage does not cause the possible contamination of the sterilizer load during the drying phase.

AKI

AKI is the abbreviation for "Arbeitskreis Instrumentenaufbereitung"

Authorised technician

The term "authorised technician" refers to an employee of a customer service provider or stockist who has been trained and authorised by MELAG to perform maintenance and installation work on MELAG devices. Only they may carry out this work.

Batch

The batch is the composition of items which has been subject to the same reprocessing procedure.

Bowie & Dick test

Steam penetration test with a standard test package; described in EN 285; the test is recognized in the large-scale sterilization industry.

CF card

The CF card is a memory medium for digital data; Compact Flash is an official standard, i.e. these memory cards can be used in every device fitted with the corresponding slot. The CF card can be read by every device that supports the standard and where necessary, written on.

Competent personnel

Trained personnel in accordance with national specifications for the respective area of application (dentistry, medicine, podiatry, veterinary medicine, cosmetics, piercing, tattoo) with the following contents: knowledge of instruments, hygiene and microbiology, risk assessment and classification of medical devices and instrument reprocessing.

Condensate

Fluid (e.g. water) produced by the cooling of and resultant separation from the vaporous state.

Conductivity

is the ability of a conductive chemical substance or mixture of substances to conduct or transfer energy or other substances or particles in space.

Corrosion

The chemical alteration or destruction of metal materials by water and chemicals

Delay in boiling

This refers to the phenomenon that it is possible under certain circumstances to heat a fluid beyond its boiling point without them boiling. This represents an unstable state; even low-level agitation can produce a large bubble within the shortest period, which expands explosively.

Demineralised water

Water without the minerals usually found in normal spring or tap water; is produced through ion exchange of normal tap water. It is used here as feed water.

DGSV

Abb.: Deutsche Gesellschaft für Sterilgutverordnung (German Association for the Sterilized Equipment Ordinance). The DSGV training centres are specified in DIN 58946, part 6 as "Requirements of personnel".

DGUV Regulation 1

DGUV is the abbreviation for "Deutsche Gesetzliche Unfallversicherung" (German Statutory Accident Insurance). The regulation 1 governs the principles of prevention.

DIN 58946-7

Standard – sterilization - steam steam sterilizers - part 7: Building requirements and requirements placed on the operating agents and the operation of steam sterilizers in the health-care branch

DIN 58953

Standard – sterilization, sterile equipment supply

Distilled water

From the Latin aqua destillata; also referred to as aqua dest; water which to a great extent is free from salts, organic material and micro-organisms, is produced from normal tap water or pre-cleaned water through the process of distillation (evaporation and subsequent condensation). Distilled water is used, for example, as feed water for steam sterilizers.

Dynamic pressure test of the sterilization chamber

Serves to prove that the rate of pressure variations during a sterilization cycle does not exceed a particular value which could result in the damage of the packaging material. [see also EN 13060]

Empty chamber test

Test run without a load, performed to assess the performance of a sterilizer without the influence of a load; facilitating verification of the temperatures maintained in comparison to the temperatures set. [see EN 13060]

EN 13060

Standard – small steam sterilizers

EN 867-5

Standard – non-biological systems for use in sterilizers – part 5: The determination of indicator systems and test bodies for the performance inspection of type B and type S small sterilizers.

EN ISO 11140-1

Standard – the sterilization of products for use in medical treatment – chemical indicators – part 1: General requirements

EN ISO 11607-1

Standard - packaging for medical devices to be sterilized in the final packaging - Part 1: Requirements placed on materials, sterile barrier systems and packaging systems

Feed water

Feed water is required to produce steam for sterilization. Guide values for water quality in accordance with EN 285 / EN 13060 – Appendix C

Heat-up phase

The time required after the steam sterilizer has been switched on / after the start of a sterilization program, to heat the double-jacket steam generator before the sterilization procedure starts. The duration is dependent on temperature at which sterilization takes place.

Hollow body A

See product with narrow lumen

Hollow body B

See simple hollow body

Load

Products, devices or materials that are reprocessed together in one operating cycle.

Mixed loads

wrapped and unwrapped load within a single batch

Multiple wrapping

e.g. wrapped instruments sealed in a double layer of film or wrapped in film and placed in an additional container or a container wrapped in textiles.

Porous

Pervious to liquids and air, e.g. textiles

Porous full load

Serves to prove that the values set on the control satisfy the necessary sterilization conditions in porous loads with a maximum mass for which the sterilizer is designed in accordance with EN 13060 [see also EN 13060].

Porous partial load

Serves to prove that the values set on the control allow steam to enter the pre-determined test package quickly and equally [see also EN 13060]

Process evaluation system

Also known as the self-monitoring system – this observes itself and compares the various sensors during a current program.

Product with narrow lumen

An article open on one side to which the following applies: $1 \leq L/D \leq 750$ and $L \leq 1500$ mm or an article with an opening on both sides which is: $2 \leq L/D \leq 1500$ and $L \leq 3000$ mm and which does not correspond to a hollow body article B; L...length of hollow body article; D...Diameter of hollow body article [see also EN 13060]

RKI

Abbreviation for "Robert Koch Institute". It is one of the most important bodies for the safeguarding of public health in Germany.

Simple hollow bodies

An article open on one side to which the following applies: $1 \leq L/D \leq 5$ and $D \geq 5$ mm or an article with an opening on both sides which is: $2 \leq L/D \leq 10$ and $D \geq 5$ L...hollow body article length D... hollow body article diameter [see EN 13060]

Single wrapping

Wrapped once e.g. instruments sealed in foil – in opposition to: Multiple wrapping

Soft sterilization packaging

e.g. a paper bag or transparent sterilization packaging

Solid

Without hollows or gaps, solid, compact, closed

Solid load

Serves to prove that the necessary sterilization conditions have been reached within the entire load with the values set in the control. The load must represent the largest weight of massive instruments designed for sterilization in a sterilizer in accordance with EN 13060. [see also EN 13060]

Sterile barrier system

A closed minimum packaging which prevents the entrance of micro-organisms e.g. through sealing bags, sealed and re-usable containers and folded sterilization towels etc.

Sterile material

Also referred to as a batch: a load which has already been sterilized, i.e. is sterile

Sterilization chamber

The interior of a sterilizer accommodates the load

Sterilization material

Unsterile, sterilizable material which is still to be sterilized.

Vacuum

In common parlance, an area devoid of all material
In the technical sense: volumes with a reduced gas pressure (at least air pressure)

MELAG Medizintechnik GmbH & Co. KG

Geneststraße 6-10
10829 Berlin
Germany

Email: info@melag.com
Web: www.melag.com

Original instructions

Responsible for content: MELAG Medizintechnik GmbH & Co. KG
We reserve the right to technical alterations

Your stockist

