



ORDER INFORMATION

Ceramill TI-Forms and original titanium abutment blanks for all current implant systems

Condition: Ceramill Motion 2 (5X)			
Abutment blank and components for individual single titanium abutments			
Products for restorations		Products for the scan	
Screw		Screw	
Titanium abutment blank		Scan body	



Ceramill TI-Forms Starter Kit

Use of the TI-Forms components and the instruments necessary for screw retention

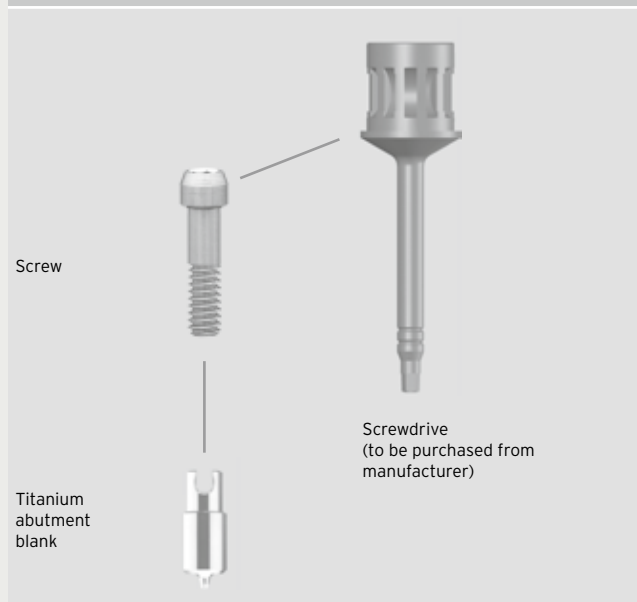

All components for implant systems, which are not listed in our product catalogue, must be ordered directly from the manufacturer. Screwdrivers should be purchased from the manufacturer of the respective implant systems. All product brands labelled with TM/® are registered trademarks of the manufacturer named. All original implants should be purchased from the respective manufacturer.



Titanium base for all conventional implant systems

Condition: Ceramill Motion or Ceramill Motion 2 Titanium bases and components for individual single abutments		Condition: Ceramill Motion 2 5X only Conical SR titanium bases and components for multi-unit, screw-retained restorations (SR = Screw retained)	
Products for restorations	Products for the scan	Products for restorations	Products for the scan
Screw		Screw SR	
Titanium base		Adhesive coping SR	
	Scan body	Titanium base SR	

Use of the TI-Connect components and the instruments necessary for screw retention

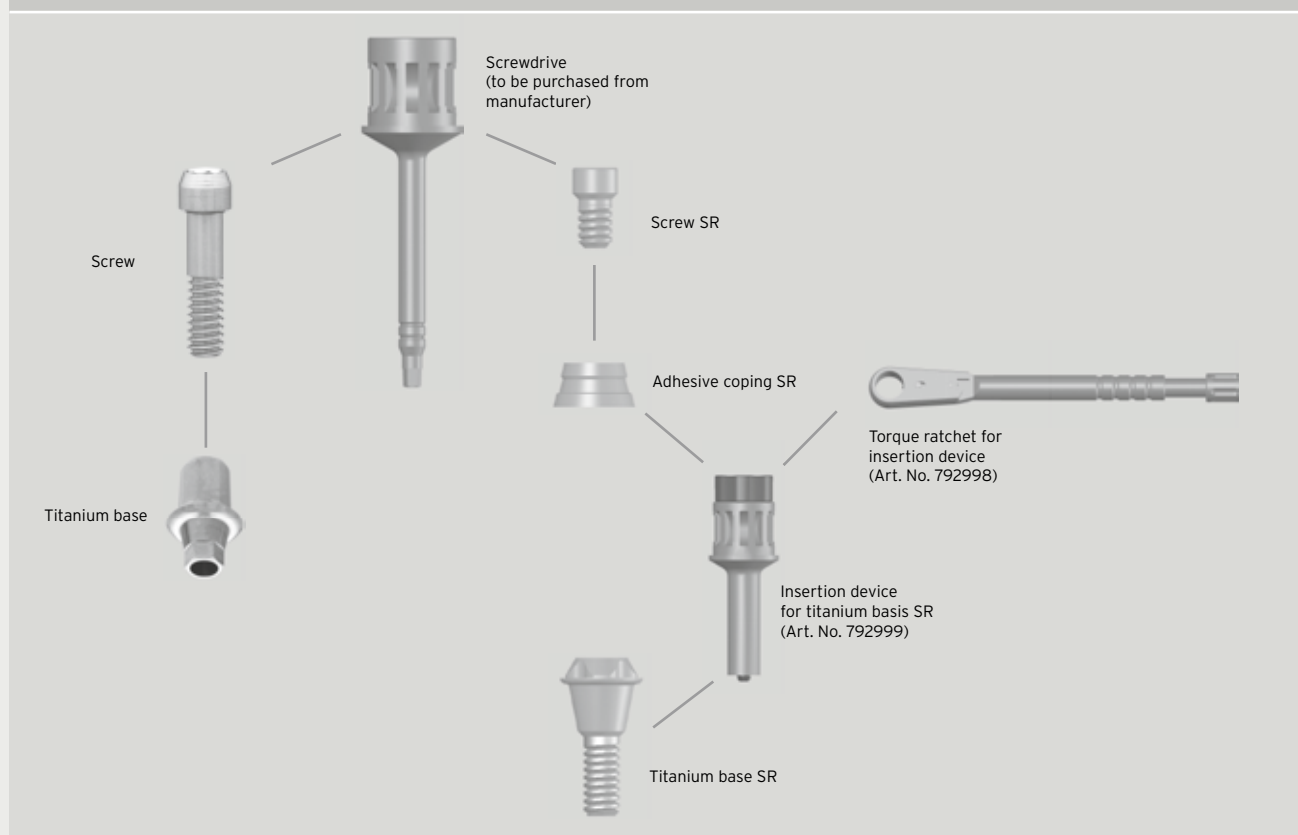

All components for implant systems, which are not listed in our product catalogue, must be ordered directly from the manufacturer. Screwdrivers should be purchased from the manufacturer of the respective implant systems. All product brands labelled with TM/® are registered trademarks of the manufacturer named. All original implants should be purchased from the respective manufacturer.

Original Straumann titanium abutment blanks

Implant manufacturer	Implant system	Compatible original abutment blanks for customised titanium abutments
Straumann	BoneLevel®	◆
Straumann	SynOcta®	◆
The Amann Girrbach product portfolio is continually being extended by implant systems.		◆ To be ordered from Amann Girrbach ● To be ordered from the implant manufacturer or manufacturer of the titanium bases

CAD/CAM System	Straumann® BoneLevel®				Straumann® SynOcta®			
	3.3 mm (NC)	4.1/4.8 mm (RC)			4.8 mm (RN)	6.5 mm (WN)		
Laboratory implant	 792331	 792332			 792532	 792533		

Abutment blanks and components for customised single abutments

Titanium abutment blank	Ceramill Motion 2 5X only	 022.0058	 022.0059			 048.824	 048.825		
Scan body		 025.2915	 025.4915			 048.168	 048.169		
Screw		 025.2900	 025.4900			 048.356	 048.356		
Torque		35 Ncm	35 Ncm			35 Ncm	35 Ncm		

All components for implant systems, which are not listed in our product catalogue, must be ordered directly from the manufacturer. Screwdrivers should be purchased from the manufacturer of the respective implant systems. All product brands labelled with TM/® are registered trademarks of the manufacturer named. All original implants should be purchased from the respective manufacturer.



Ceramill TI-Forms, Ceramill TI-Connect, Ceramill TI-Connect SR

Range	Implant manufacturer	Implant system	Ceramill TI-Forms Compatible abutment blanks for customised titanium abutments	Ceramill TI-Connect Compatible titanium bases for single abutments	Ceramill TI-Connect SR Compatible conical titanium bases for multi-unit restorations
1	Astra Tech	Osseo Speed®	◆	◆	◆
2	Biomet 3i	Osseotite® Certain®	◆	◆	◆
3	Straumann	BoneLevel®	◆	◆	◆
4	Nobel Biocare	Nobel Active®	◆	◆	◆
5	Straumann	SynOcta®	◆	◆	◆
6	Nobel Biocare	Replace Select®	◆	◆	◆
7	Biomet 3i	Osseotite®	◆	◆	◆
8	Nobel Biocare	Branemark®	◆	◆	◆
9	Zimmer	Tapered Screw-Vent®	◆	◆	◆
10	Dentsply Friadent	Frialit / Xive®	◆	◆	◆
11	Camlog	Camlog®		●	◆
12	Camlog	ConeLog®	◆	●	◆
13	Dentsply-Friadent	Ankylos®			◆
14	Bredent Medical	Sky®		●	◆
-	Thommen Medical	SPI®ELEMENT SPI®CONTACT SPI®ONETIME		●	
-	Prowital	Prowital-Implantate		●	
-	MIS	SEVEN M4 C1		●	●
-	medentis medical GmbH	ICX-templant®		●	
-	Dentaurum Implants GmbH	tioLogic®		●	
-	OSSTEM Implant	GS US SS		●	
-	Dentium	Implantium		●	
-	Nemris	Aesthura Classic		●	

- ◆ To be ordered from Amann Girrbach
- To be ordered from the implant manufacturer or manufacturer of the titanium bases

All components for implant systems, which are not listed in our product catalogue, must be ordered directly from the manufacturer. Screwdrivers should be purchased from the manufacturer of the respective implant systems. All product brands labelled with TM/® are registered trademarks of the manufacturer named. All original implants should be purchased from the respective manufacturer.

ORDER INFORMATION

Range	CAD/CAM System	Range one for Astra Tech® OsseoSpeed®				Range two for Biomet 3i® Osseotite® Certain®			
		Kit a 3.5/4.0 mm	Kit b 4.5/5.0 mm			Kit a 3.4 mm	Kit b 4.1 mm	Kit c 5.0 mm	
Laboratory implant		 792131	 792132			 792231	 792232	 792233	

Abutment blanks, titanium basis and components for individual abutments

Titanium abutment blank	Ceramill Motion 2 5X only	 7921101	 7921102			 7922101	 7922102	 7922103	
Titanium base incl. screw	Ceramill Motion or Ceramill Motion 2	 792111	 792112			 792211	 792212	 792213	
Scan body	Ceramill Motion or Ceramill Motion 2	 792121	 792122			 792221	 792222	 792222	
Screw	Ceramill Motion or Ceramill Motion 2	 792141	 792142			 792241	 792241	 792241	
Torque		25 Ncm	25 Ncm			20 Ncm	20 Ncm	20 Ncm	

Conical SR titanium bases and components for multi-unit, screw-retained restorations (SR = Screw retained)

Titanium base SR H 0.5 mm	Ceramill Motion 2 5X only	 7921511	 7921521			 7922511	 7922521		
Titanium base SR H 1.5 mm	Ceramill Motion 2 5X only	 7921512	 7921522			 7922512	 7922522		
Titanium base SR H 2.5 mm	Ceramill Motion 2 5X only	 7921513	 7921523			 7922513	 7922523		
Adhesive coping SR (incl. screw SR) H 3 mm	Ceramill Motion 2 5X only	 792161	 792161			 792261	 792261		
Adhesive coping SR (incl. screw SR) H 4 mm	Ceramill Motion 2 5X only	 792162	 792162			 792262	 792262		
Scan body SR	Ceramill Motion 2 5X only	 792171	 792171			 792171	 792171		
Screw SR	Ceramill Motion 2 5X only	 792181	 792181			 792281	 792281		

All components for implant systems, which are not listed in our product catalogue, must be ordered directly from the manufacturer. Screwdrivers should be purchased from the manufacturer of the respective implant systems. All product brands labelled with TM/® are registered trademarks of the manufacturer named. All original implants should be purchased from the respective manufacturer.



ORDER INFORMATION

Range	CAD/CAM System	Range three for Straumann® BoneLevel®				Range four for Nobel Biocare® Nobel Active™			
		Kit a 3.3 mm (NC)	Kit b 4.1/4.8 mm (RC)			Kit a 3.5 mm (NP)	Kit b 4.3/5.0 mm (RP)		
Laboratory implant		 792331	 792332			 792431	 792432		

Abutment blanks, titanium basis and components for individual abutments

Titanium abutment blank	Ceramill Motion 2 5X only	 7923101	 7923102			 7924101	 7924102		
Titanium base incl. screw	Ceramill Motion or Ceramill Motion 2	 792311	 792312			 792411	 792412		
Scan body	Ceramill Motion or Ceramill Motion 2	 792321	 792322			 792421	 792422		
Screw	Ceramill Motion or Ceramill Motion 2	 792341	 792341			 792441	 792442		
Torque		35 Ncm	35 Ncm			25 Ncm	35 Ncm		

Conical SR titanium bases and components for multi-unit, screw-retained restorations (SR = Screw retained)

Titanium base SR H 0.5 mm	Ceramill Motion 2 5X only	 7923511	 7923521			 7924511	 7924521		
Titanium base SR H 1.5 mm	Ceramill Motion 2 5X only	 7923512	 7923522			 7924512	 7924522		
Titanium base SR H 2.5 mm	Ceramill Motion 2 5X only	 7923513	 7923523			 7924513	 7924523		
Adhesive coping SR (incl. screw SR) H 3 mm	Ceramill Motion 2 5X only	 792361	 792361			 792461	 792461		
Adhesive coping SR (incl. screw SR) H 4 mm	Ceramill Motion 2 5X only	 792362	 792362			 792462	 792462		
Scan body SR	Ceramill Motion 2 5X only	 792171	 792171			 792171	 792171		
Screw SR	Ceramill Motion 2 5X only	 792381	 792381			 792481	 792481		

All components for implant systems, which are not listed in our product catalogue, must be ordered directly from the manufacturer. Screwdrivers should be purchased from the manufacturer of the respective implant systems. All product brands labelled with TM/® are registered trademarks of the manufacturer named. All original implants should be purchased from the respective manufacturer.

ORDER INFORMATION

Range	CAD/CAM System	Range five for Straumann® SynOcta®			Range six for Nobel Biocare® Replace Select®			
		Kit a 3.5 mm (NN)	Kit b 4.8 mm (RN)	Kit c 6.5 mm (WN)	Kit a 3.5 mm (NP)	Kit b 4.3 mm (RP)	Kit c 5.0 mm (WP)	Kit d 6.0 mm
Laboratory implant								
		792531	792532	792533	792631	792632	792633	792634

Abutment blanks, titanium basis and components for individual abutments

Titanium abutment blank	Ceramill Motion 2 5X only							
		7925101	7925102S	7925103S	7926101	7926102	7926103	
Titanium base incl. screw	Ceramill Motion or Ceramill Motion 2							
		792511	792512	792513	792611	792612	792613	792614
Scan body	Ceramill Motion or Ceramill Motion 2							
		792521	792522	792523	792621	792622	792623	792624
Screw	Ceramill Motion or Ceramill Motion 2							
		792541	792542	792542	792641	792642	792642	792642
Torque		35 Ncm	35 Ncm	35 Ncm	35 Ncm	35 Ncm	35 Ncm	







Conical SR titanium bases and components for multi-unit, screw-retained restorations (SR = Screw retained)

Titanium base SR H 0 mm	Ceramill Motion 2 5X only							
			7925520					
Titanium base SR H 0.5 mm	Ceramill Motion 2 5X only							
					7926511	7926521		
Titanium base SR H 1.5 mm	Ceramill Motion 2 5X only							
					7926512	7926522		
Titanium base SR H 2.5 mm	Ceramill Motion 2 5X only							
					7926513	7926523		
Adhesive coping SR (incl. screw SR) Range 5 - H 3.75 mm Range 6 - H 3 mm	Ceramill Motion 2 5X only							
			792561		792661	792661		
Adhesive coping SR (incl. screw SR) H 4 mm	Ceramill Motion 2 5X only							
					792662	792662		
Scan body SR	Ceramill Motion 2 5X only							
			792571		792171	792171		
Screw SR	Ceramill Motion 2 5X only							
			792581		792681	792681		

All components for implant systems, which are not listed in our product catalogue, must be ordered directly from the manufacturer. Screwdrivers should be purchased from the manufacturer of the respective implant systems. All product brands labelled with TM/® are registered trademarks of the manufacturer named. All original implants should be purchased from the respective manufacturer.



ORDER INFORMATION

Range	CAD/CAM System	Range seven for Biomet 3i Osseotite®			Range eight for Nobel Biocare Brånemark®		
		Kit a 3.4 mm	Kit b 4.1 mm	Kit c 5.0 mm	Kit a 3.5 mm (NP)	Kit b 4.1 mm (RP)	Kit c 5.1 mm (WP)
Laboratory implant							
		792731	792732	792733	792831	792832	792833

Abutment blanks, titanium basis and components for individual abutments







Titanium abutment blank	Ceramill Motion 2 5X only						
		7927102			7928101	7928102	7928103
Titanium base incl. screw	Ceramill Motion or Ceramill Motion 2						
		792711	792712	792713	792811	792812	792813
Scan body	Ceramill Motion or Ceramill Motion 2						
		792721	792722	792722	792821	792822	792823
Screw	Ceramill Motion or Ceramill Motion 2						
		792741	792741	792741	792841	792842	792843
Torque		35 Ncm			35 Ncm	35 Ncm	35 Ncm

Conical SR titanium bases and components for multi-unit, screw-retained restorations (SR = Screw retained)

Titanium base SR H 2.5 mm	Ceramill Motion 2 5X only						
		7927513	7927523		7928513	7928523	
Adhesive coping SR (incl. screw SR) 3 mm	Ceramill Motion 2 5X only						
		792761	792761		792861	792861	
Adhesive coping SR (incl. screw SR) 4 mm	Ceramill Motion 2 5X only						
		792762	792762		792862	792862	
Scan body SR	Ceramill Motion 2 5X only						
		792171	792171		792171	792171	
Screw SR	Ceramill Motion 2 5X only						
		792781	792781		792881	792881	

All components for implant systems, which are not listed in our product catalogue, must be ordered directly from the manufacturer. Screwdrivers should be purchased from the manufacturer of the respective implant systems. All product brands labelled with TM/® are registered trademarks of the manufacturer named. All original implants should be purchased from the respective manufacturer.

























ORDER INFORMATION

Range	CAD/CAM System	Range nine for Zimmer Tapered Screw-Vent®			Range ten for Dentsply Friadent Frialit/Xive®			
		Kit a 3.5 mm	Kit b 4.5 mm	Kit c 5.7 mm	Kit a 3.4 mm	Kit b 3.8 mm	Kit c 4.5 mm	Kit d 5.5 mm
Laboratory implant		 792931	 792932	 792933	 7921031	 7921032	 7921033	 7921034

Abutment blanks, titanium basis and components for individual abutments

Titanium abutment blank	Ceramill Motion 2 5X only	 7929101	 7929102	 7929103	 79210101	 79210102	 79210103	 79210104
Titanium base incl. screw	Ceramill Motion or Ceramill Motion 2	 792911	 792912	 792913	 7921011	 7921012	 7921013	 7921014
Scan body	Ceramill Motion or Ceramill Motion 2	 792921	 792922	 792923	 7921021	 7921022	 7921023	 7921023
Screw	Ceramill Motion or Ceramill Motion 2	 792941	 792941	 792941	 7921041	 7921041	 7921041	 7921041
Torque		30 Ncm	30 Ncm	30 Ncm	25 Ncm	25 Ncm	25 Ncm	25 Ncm

Conical SR titanium bases and components for multi-unit, screw-retained restorations (SR = Screw retained)

Titanium base SR H 0.5 mm	Ceramill Motion 2 5X only	 7929511	 7929521		 79210511	 79210521	 79210531	
Titanium base SR H 1.5 mm	Ceramill Motion 2 5X only	 7929512	 7929522		 79210512	 79210522	 79210532	
Titanium base SR H 2.5 mm	Ceramill Motion 2 5X only	 7929513	 7929523		 79210513	 79210523	 79210533	
Adhesive coping SR (incl. screw SR) H 3 mm	Ceramill Motion 2 5X only	 792961	 792961		 7921061	 7921061	 7921061	
Adhesive coping SR (incl. screw SR) H 4 mm	Ceramill Motion 2 5X only	 792962	 792962		 7921062	 7921062	 7921062	
Scan body SR	Ceramill Motion 2 5X only	 792171	 792171		 792171	 792171	 792171	
Screw SR	Ceramill Motion 2 5X only	 792981	 792981		 7921081	 7921081	 7921081	









All components for implant systems, which are not listed in our product catalogue, must be ordered directly from the manufacturer. Screwdrivers should be purchased from the manufacturer of the respective implant systems. All product brands labelled with TM/® are registered trademarks of the manufacturer named. All original implants should be purchased from the respective manufacturer.





ORDER INFORMATION

Range	CAD/CAM System	Range eleven for Camlog			Range twelve for Conelog		
		Kit a 3.3 mm	Kit b 3.8 mm	Kit c 4.3 mm	Kit a 3.3 mm	Kit b 3.8/4.3 mm	Kit c 5.0 mm
Laboratory implant		To be ordered directly from Camlog					
					7921231	7921232	7921233

Titanium basis and components for individual abutments



Titanium abutment blank	Ceramill Motion 2 5X only							
		79212101	79212102	79212103				
Scan body	Ceramill Motion 2 5X only							
		7921221	7921222	7921223				
Screw	Ceramill Motion 2 5X only							
		7921241	7921241	7921242				
Torque		20 Ncm	20 Ncm	20 Ncm				

Conical SR titanium bases and components for multi-unit, screw-retained restorations (SR = Screw retained)

Titanium base SR H 0.5 mm	Ceramill Motion 2 5X only								
		79211511	79211521	79211531		79212511	79212521		
Titanium base SR H 1.5 mm	Ceramill Motion 2 5X only								
		79211512	79211522	79211532		79212512	79212522		
Titanium base SR H 2.5 mm	Ceramill Motion 2 5X only								
		79211513	79211523	79211533		79212513	79212523		
Adhesive coping SR (incl. screw SR) H 3 mm	Ceramill Motion 2 5X only								
		7921161	7921161	7921161		7921261	7921261		
Adhesive coping SR (incl. screw SR) H 4 mm	Ceramill Motion 2 5X only								
		7921162	7921162	7921162		7921262	7921262		
Scan body SR	Ceramill Motion 2 5X only								
		792171	792171	792171		792171	792171		
Screw SR	Ceramill Motion 2 5X only								
		7921181	7921181	7921181		7921281	7921281		

All components for implant systems, which are not listed in our product catalogue, must be ordered directly from the manufacturer. Screwdrivers should be purchased from the manufacturer of the respective implant systems. All product brands labelled with TM/® are registered trademarks of the manufacturer named. All original implants should be purchased from the respective manufacturer.

ORDER INFORMATION

Range	CAD/CAM System	Range thirteen for Dentsply Friadent Ankylos®				Range fourteen for Bredent Medical Sky®			
		Kit a 3.5 - 7.0 mm				Kit a 3.5 - 5.5 mm			
Laboratory implant									
		7921331				7921431			

Conical SR titanium bases and components for multi-unit, screw-retained restorations (SR = Screw retained)

Titanium base SR H 0.5 mm	Ceramill Motion 2 5X only								
		79213511				79214511			
Titanium base SR H 1.5 mm	Ceramill Motion 2 5X only								
		79213512				79214512			
Titanium base SR H 2.5 mm	Ceramill Motion 2 5X only								
		79213513				79214513			
Adhesive coping SR (incl. screw SR) H 3 mm	Ceramill Motion 2 5X only								
		7921361				7921461			
Adhesive coping SR (incl. screw SR) H 4 mm	Ceramill Motion 2 5X only								
		7921362				7921462			
Scan body SR	Ceramill Motion 2 5X only								
		792171				792171			
Screw SR	Ceramill Motion 2 5X only								
		7921381				7921481			

Accessory

792999 Insertion device for titanium basis SR, for all ranges

792998 Torque ratchet for insertion device (792999)

Ceramill TI-Forms Starter Kit

760100 Ceramill TI-Forms Starter Kit

179278 Blank holder rotational milling

760615 Roto TI 1.0

760616 Roto TI 2.0

179285 Storage bar

All components for implant systems, which are not listed in our product catalogue, must be ordered directly from the manufacturer.

Screwdrivers should be purchased from the manufacturer of the respective implant systems.

All product brands labelled with TM/® are registered trademarks of the manufacturer named.

All original implants should be purchased from the respective manufacturer.





AMANNGIRRBACH

HEADQUARTER AUSTRIA

Amann Girrbach AG
Koblach, Austria
Fon +43 5523 62333-105
austria@amanngirrbach.com

GERMANY

Amann Girrbach GmbH
Pforzheim, Germany
Fon +49 7231 957-100
germany@amanngirrbach.com

NORTH AMERICA

Amann Girrbach North America, LP
Charlotte, U.S.A.
Fon +1 704 837 1404
america@amanngirrbach.com

BRASIL

Amann Girrbach Brasil LTDA
Curitiba, Brasil
Fon +55 41 3287 0897
brasil@amanngirrbach.com

ASIA

Amann Girrbach Asia PTE LTD.
Singapore, Asia
Fon +65 6592 5190
singapore@amanngirrbach.com

CHINA

Amann Girrbach China Co., Ltd.
Beijing, China
Fon +86 10 8886 6064
china@amanngirrbach.com

www.amanngirrbach.com