

---

New as of:

01.2022

---



# Sinius / Sinius CS / Sinius TS

Instructions for Use

English



# Table of contents

<b>1</b>	<b>General information.....</b>	<b>10</b>
1.1	Dear Customer,.....	10
1.2	Contact information.....	10
1.3	General information on the operating Instructions.....	11
1.4	Scope of these Operating Instructions.....	11
1.5	Other valid documents.....	11
1.6	Warranty and liability.....	12
1.7	Intended use.....	12
1.8	Obligation to notify authorities.....	12
1.9	Formats and symbols used.....	13
<b>2</b>	<b>Safety instructions.....</b>	<b>14</b>
2.1	Identification of the danger levels.....	14
2.2	Information on the unit.....	14
2.3	On-site installation.....	14
2.4	Installation of the treatment center.....	15
2.5	Media quality.....	15
2.6	Connection to the public drinking water system.....	15
2.7	Maintenance and repair.....	16
2.8	Trouble-free operation.....	16
2.9	Vacuum system.....	16
2.10	Patient chair.....	17
2.11	Intermittent operation.....	17
2.12	Ventilation slots.....	17
2.13	Touchscreen.....	18
2.14	Care, cleaning, and disinfecting agents.....	18
2.15	Care and cleaning instructions for the practice team.....	18
2.16	Modifications and extensions of the system.....	18
2.17	Electromagnetic compatibility.....	18
2.18	Electrostatic discharge.....	19
2.19	Dismantling/Installation.....	20
2.20	Operating environment.....	20
<b>3</b>	<b>Unit description.....</b>	<b>21</b>
3.1	Standards/Approvals.....	21
3.2	Technical data.....	23
3.3	System overview.....	25
3.4	Patient chair.....	28

3.5	Headrest.....	29
3.5.1	Motor-driven headrest .....	29
3.5.2	Double-jointed head support .....	30
3.6	Foot control .....	31
3.7	Dentist element .....	32
3.7.1	Instrument positions .....	37
3.7.2	EasyTouch user interface.....	38
3.7.3	Touchscreen.....	39
3.7.4	Fixed keys on the dentist element.....	40
3.8	Assistant element.....	42
3.8.1	Instrument positions .....	43
3.8.2	User interface .....	44
3.8.3	Fixed keys on the assistant element .....	44
3.9	Water unit.....	45
3.10	External device connection .....	47
<b>4</b>	<b>Operation .....</b>	<b>49</b>
4.1	Starting up the treatment center.....	49
4.1.1	Initial startup .....	49
4.1.2	Switching the treatment center on/off.....	49
4.1.2.1	Power switch.....	49
4.1.2.2	Standby switch.....	50
4.1.3	Selecting a user profile.....	51
4.2	Control concept of touchscreen .....	52
4.2.1	Virtual function keys .....	52
4.2.2	Start program operating modes.....	53
4.2.3	Sub-screens and settings screens .....	56
4.2.4	Status bar .....	57
4.3	Foot control .....	58
4.3.1	Wireless foot control.....	58
4.3.1.1	Setting the wireless foot control on the treatment center.....	58
4.3.1.2	Battery voltage message .....	58
4.3.2	Operating the foot control.....	58
4.3.3	Using the cursor control .....	60
4.3.3.1	Functionality.....	60
4.3.3.2	Operating the cursor control .....	61
4.4	Patient chair .....	63
4.4.1	Safety instructions .....	63
4.4.2	Safety stop .....	64
4.4.3	Triggering an immediate movement stop.....	65
4.4.4	Armrests .....	66
4.4.5	Vario footrest.....	66

4.4.6	Adjusting the motor-driven headrest .....	67
4.4.6.1	Moving the headrest in/out .....	67
4.4.6.2	Inclining the headrest.....	67
4.4.7	Adjusting the double articulating headrest .....	69
4.4.8	Moving the patient chair via chair programs.....	70
4.4.8.1	Moving the patient chair to the entry/exit position.....	70
4.4.8.2	Moving the patient chair to the mouth rinsing position.....	71
4.4.8.3	Using the last position memory function .....	71
4.4.8.4	Activating other chair programs .....	72
4.4.9	Moving the chair manually.....	73
4.4.9.1	Open manual chair setting screen .....	73
4.4.9.2	Tilting the patient couch.....	73
4.4.9.3	Adjusting the chair height .....	74
4.4.10	Creating chair and shock positioning programs .....	75
4.4.11	Setting the active lumbar support.....	76
4.5	Dentist element .....	77
4.5.1	Maximum load capacity .....	77
4.5.2	Height adjustment .....	77
4.5.3	Positioning the dentist element .....	78
4.5.4	Fixed keys on the dentist element.....	81
4.5.4.1	Standby switch.....	81
4.5.4.2	Program change keys.....	81
4.5.4.3	Timer function .....	82
4.5.4.4	Shock positioning.....	83
4.5.4.5	Operating light .....	83
4.5.4.6	Composite function .....	83
4.5.4.7	Tumbler filling .....	83
4.5.4.8	Flushing of the cuspidor bowl .....	84
4.5.4.9	Freely selectable function .....	85
4.5.4.10	Clean .....	85
4.5.4.11	Setup .....	85
4.5.5	Quick setting keys and function levels .....	86
4.5.6	Saving instrument settings .....	88
4.5.7	Placing the instruments in their holders .....	90
4.5.8	General instrument functions .....	92
4.5.8.1	Opening the sub-screen .....	92
4.5.8.2	Selecting a coolant .....	92
4.5.8.3	Switching the preselected coolant on/off .....	92
4.5.8.4	Setting the ApexLocator .....	93
4.5.8.5	Switch instrument light on/off.....	93
4.5.8.6	Setting the foot control as a direct starter or speed foot control ..	93
4.5.8.7	Setting the spray amount.....	94

4.5.8.8	Preparing for use of NaCl saline solution .....	96
4.5.8.9	Setting the NaCl flow rate .....	98
4.5.9	Multifunctional syringe Sprayvit M .....	99
4.5.9.1	Structure .....	99
4.5.9.2	Product labeling .....	99
4.5.9.3	Media supply .....	99
4.5.9.4	Safety instructions .....	100
4.5.9.5	Connecting the instrument hose .....	101
4.5.9.6	Attach/remove the housing and nozzle .....	101
4.5.9.7	Applying air, water, or spray .....	102
4.5.9.8	Instrument light on/off and water temperature adjustment .....	102
4.5.10	Highspeed handpiece .....	104
4.5.10.1	Using the highspeed handpiece .....	104
4.5.10.2	Setting the light of the highspeed handpiece .....	104
4.5.11	Motor .....	106
4.5.11.1	Motor versions .....	106
4.5.11.2	Product labeling .....	108
4.5.11.3	Technical Data .....	108
4.5.11.4	Safety instructions .....	109
4.5.11.5	Connecting the instrument hose .....	109
4.5.11.6	Replacing the instrument .....	110
4.5.11.7	Adjusting the cooling spray .....	111
4.5.11.8	Setting the speed .....	111
4.5.11.9	Setting the direction of rotation .....	113
4.5.11.10	Implantology/endodontics treatments with motor .....	115
4.5.12	ApexLocator .....	118
4.5.12.1	Preparing to use the ApexLocator .....	119
4.5.12.2	Distance display .....	121
4.5.12.3	Beeps .....	124
4.5.12.4	Performing manual measurements with the file clamp .....	125
4.5.13	SiroSonic TL scaler .....	126
4.5.13.1	Safety instructions .....	126
4.5.13.2	Setting the intensity .....	126
4.5.14	Implantology and endodontic treatment .....	130
4.5.14.1	Treatment selection .....	131
4.5.14.2	Implantology .....	133
4.5.14.3	Endodontics .....	139
4.6	Assistant element .....	150
4.6.1	Maximum load capacity .....	150
4.6.2	Positioning .....	150
4.6.3	Fixed keys on the assistant element .....	150
4.6.3.1	Tumbler filling .....	151
4.6.3.2	Flushing of the cuspidor bowl .....	151

4.6.3.3	Operating light .....	151
4.6.3.4	Chair programs S and O.....	151
4.6.3.5	Hash key.....	152
4.6.4	Suction handpieces .....	153
4.6.5	Multifunctional syringe Sprayvit M.....	155
4.6.6	Mini LED curing light .....	156
4.6.6.1	Safety instructions .....	156
4.6.6.2	Symbols on the mini LED .....	156
4.6.6.3	Connecting the Mini L.E.D.....	157
4.6.6.4	Functional description.....	157
4.6.6.5	Operating the Mini LED .....	158
4.6.6.6	Technical data .....	159
4.7	Water unit.....	160
4.7.1	Swiveling the cuspidor bowl .....	160
4.7.2	Tumbler filling with automatic sensor control .....	160
4.7.3	Adjusting the water amount for flushing .....	161
4.7.4	Self-sufficient water supply.....	162
4.8	Tray.....	165
4.8.1	Tray on the support arm (for Sinus).....	165
4.8.2	Tray on the Sinus CS dentist element .....	166
4.8.3	Tray on the Sinus TS dentist element .....	167
4.8.4	Cup holder.....	168
4.9	Panoramic X-ray image viewer .....	169
4.9.1	Switching on/off the X-ray viewer or white screen on the Sivation monitor ...	169
4.9.2	Attaching the anti-glare film .....	170
4.10	Operating light.....	171
4.10.1	Switching the operating light on/off .....	171
4.10.2	Setting the brightness, color temperature, and sensor control.....	171
4.10.3	Switching the dentist element composite function on/off.....	172
4.10.4	Activating operating light on the assistant element .....	172
4.11	X-ray tube unit.....	173
4.12	Sivation Digital video system.....	174
4.12.1	Sivation monitor .....	175
4.12.2	SiroCam AF / AF+ intraoral camera .....	176
4.12.2.1	Safety instructions .....	176
4.12.2.2	Functional description.....	176
4.12.2.3	Connecting the SiroCam AF / AF+ intraoral camera .....	177
4.12.2.4	Operating the SiroCam AF / AF+ intraoral camera.....	178
4.12.2.5	Technical camera data .....	183
4.13	Operation with a PC.....	184
4.13.1	Sivation program.....	185
4.13.1.1	Starting PC communication .....	185
4.13.1.2	Communication with the media player.....	186

4.13.1.3	Communication with Microsoft PowerPoint .....	186
4.13.1.4	Communication with Sidexis .....	187
4.13.1.5	Communication with video plugin .....	189
4.13.2	USB port.....	190
4.14	Configuration of the treatment center (setup) .....	191
4.14.1	Opening the setup programs.....	191
4.14.2	Configuring the EasyTouch user interface .....	192
4.14.2.1	Switching the key sound on/off.....	192
4.14.2.2	Calibrating the touchscreen .....	192
4.14.2.3	Adjusting the touchscreen brightness.....	192
4.14.3	Setting the date and time .....	193
4.14.4	Configuring control options.....	194
4.14.4.1	Preselecting the number of user profiles .....	194
4.14.4.2	Setting the cursor control.....	194
4.14.4.3	Select the operating mode of the Start program.....	194
4.14.4.4	Switching on/off the foot control function for intraoral camera focus .....	195
4.14.4.5	Linking the spray aspirator to the 4-way foot switch .....	195
4.14.4.6	Linking the headrest tilt to the 4-way foot switch .....	196
4.14.4.7	Setting the hash key function on the assistant element.....	196
4.14.4.8	Setting the bell/hash fixed key as a pushbutton or as a switch ...	196
4.14.4.9	Key for showing/hiding white screen on the Sivation monitor .....	196
4.14.4.10	Adjust cleaning agent mixture for chemical suction hose cleaning .....	197
4.14.4.11	Switching the central supply for chemical suction hose cleaning off and on.....	197
4.14.4.12	Adjusting the temperature of the tumbler heater .....	197
4.14.4.13	Linking the tumbler heater to the chair program .....	198
4.14.5	Configure instruments .....	199
4.14.5.1	Preselecting how instrument settings are to be saved .....	199
4.14.5.2	Switching afterblow on/off.....	199
4.14.5.3	Showing/hiding the key for the external HF surgical unit.....	200
4.14.5.4	Setting the spray temperature .....	200
4.14.6	Configuring the network connection .....	201
4.14.7	Opening the service function.....	201
<b>5</b>	<b>Care, cleaning and maintenance by the practice team .....</b>	<b>202</b>
5.1	Basics.....	202
5.1.1	Intervals.....	202
5.1.2	Care, cleaning, and disinfecting agents .....	204
5.1.3	Microbiological water test.....	204
5.1.4	General handling instructions.....	205
5.1.5	Inspection, maintenance and testing.....	206

5.2	Surfaces .....	207
5.2.1	Clean/disinfect surfaces .....	207
5.2.2	Disinfect the EasyTouch.....	208
5.2.3	Disinfecting handles .....	209
5.2.4	Disinfecting the tray.....	211
5.2.5	Disinfecting the cup holder.....	212
5.2.6	Care for, clean, and disinfect upholstery .....	213
5.2.7	Cleaning the bottom surface of the mount for the backrest component.....	213
5.2.8	Thermally disinfecting the instrument holder of the dentist element and sterilizing the silicone mat .....	214
5.2.9	Thermally disinfecting the instrument holder of the assistant element and sterilizing the silicone mat .....	216
5.2.10	Clean the foot switch .....	216
5.3	Instruments and instrument hoses .....	217
5.3.1	Rinse water paths.....	217
5.3.2	Purge water paths (purge function) .....	217
5.3.3	Automatically purge water paths (autopurge function) .....	220
5.3.4	Lubricate, disinfect/sterilize the treatment instruments .....	226
5.3.4.1	Treatment instruments with separate instructions for use .....	226
5.3.4.2	Lubricate, disinfect/sterilize the Sprayvit M multifunctional syringe .....	226
5.3.4.3	Check the flow rate on the Sprayvit M multifunctional syringe ....	229
5.3.4.4	Disinfecting/sterilizing motors and adapters .....	230
5.3.4.5	Clean and disinfect/sterilize the components of the ApexLocator	233
5.3.4.6	Disinfecting/sterilizing Mini L.E.D. curing light .....	234
5.3.4.7	Cleaning/disinfecting the SiroCam AF / AF+ intraoral camera ....	235
5.3.5	Maintaining treatment instruments .....	236
5.3.5.1	Maintaining the multifunctional syringe Sprayvit M.....	236
5.3.5.2	Maintaining the motors .....	237
5.3.6	Changing the cotton wool roll on the high-speed handpiece hose and oil collector .....	239
5.4	Vacuum system.....	241
5.4.1	Cleaning the suction hoses .....	241
5.4.2	Cleaning the suction system using the suction hose adapter for the cuspidor or via an external tank .....	243
5.4.2.1	Cleaning the suction system using the suction hose adapter for the cuspidor .....	243
5.4.2.2	Cleaning the suction system via external container.....	244
5.4.3	Sterilizing/disinfecting and lubricating the suction handpieces.....	245
5.4.4	Clean the filter in the suction hoses and disinfect the suction hoses .....	246
5.5	Components of the water unit .....	248
5.5.1	Clean the gold trap .....	248
5.5.2	Clean/disinfect the cuspidor .....	249
5.5.3	Cleaning the outlet lines of the cuspidor .....	250



5.5.4	Refill disinfectant for the water paths .....	251
5.5.5	Thermally disinfect the the cartridges for sanitization adapter and suction hose cleaning .....	253
5.5.6	Change the water and air filters .....	254
5.5.7	Changing the amalgam rotor.....	255
5.5.8	Check the message system of the amalgam separator .....	258
5.5.9	Emptying the sediment container .....	259
5.5.10	Cleaning the filter insert of the standard wet suction.....	261
5.6	Sanitation .....	264
5.6.1	Interactively guided sanitization of the treatment center .....	264
5.6.2	Display sanitization report .....	270
5.6.3	Sanitizing the treatment center manually .....	272
5.6.4	Biofilm removal by the service technician .....	276
5.7	Foot control and connection box.....	277
5.7.1	Changing the battery of the wireless foot control .....	277
5.7.2	Changing the fuse of the external device connection.....	279
<b>6</b>	<b>Maintenance by the service engineer .....</b>	<b>280</b>
6.1	Inspection and maintenance .....	280
6.2	Safety checks.....	280
6.3	Maintenance Manual.....	281
<b>7</b>	<b>Malfunctions .....</b>	<b>282</b>
7.1	Error messages.....	282
7.2	Remote diagnosis .....	284
<b>8</b>	<b>Spare parts and consumables .....</b>	<b>285</b>
<b>9</b>	<b>Disposal .....</b>	<b>288</b>
9.1	Battery disposal.....	289
9.2	Disposal of disinfectants .....	289
<b>10</b>	<b>Overview of all function keys.....</b>	<b>290</b>
	<b>Index .....</b>	<b>309</b>

# 1 General information

## 1.1 Dear Customer,

We are pleased that you have equipped your practice with the Dentsply Sirona Sinus treatment center.

Our aim is to identify our customers' needs early and create innovative solutions. Together with your trade partner, you have configured the treatment center most suitable for you. The new hub of your treatment room has been tailored to your personal needs.

You have chosen a Sinus treatment center that features easy operation, innovative comfort, and high-quality design. With Sinus, we have enhanced proven functions and turned customer requirements into innovations. The EasyTouch user interface makes treatment even more pleasant and efficient.

These operating instructions are designed to assist you prior to initial use and whenever you require information later on.

We wish you a great deal of success and pleasure with Sinus.

Your Sinus team

## 1.2 Contact information

### Customer Service Center

In the event of technical queries, please use our online contact form at the following address:

<http://srvcontact.sirona.com>

### Manufacturer's address



Sirona Dental Systems GmbH  
Fabrikstrasse 31  
64625 Bensheim  
Germany

Tel.: +49 (0) 6251/16-0

Fax: +49 (0) 6251/16-2591

e-Mail: [contact@dentsplysirona.com](mailto:contact@dentsplysirona.com)

[www.dentsplysirona.com](http://www.dentsplysirona.com)

## 1.3 General information on the operating Instructions

### Observe the Operating Instructions

Please familiarize yourself with the unit by reading through these Operating Instructions before putting it into operation. It is essential that you comply with the specified warning and safety information.

**Tip:** A quick guide containing brief operating instructions has been provided to help you look up functions quickly.

### Keep documents safe

Always keep the Operating Instructions handy in case you or another user require(s) information at a later point in time. Save the Operating Instructions on the PC or print them out.

If you sell the unit, make sure that the Operating Instructions are included with it either as a hard copy or on an electronic storage device so that the new owner can familiarize himself with its functions and the specified warning and safety information.

### Online portal for technical documents

We have set up an online portal for the Technical Documents at [www.dentsplysirona.com/manuals](http://www.dentsplysirona.com/manuals). From here, you can download these Operating Instructions along with other documents. Please complete the online form if you would like a hard copy of a particular document. We will then be happy to send you a printed copy free of charge.

### Help

If you have difficulties despite having thoroughly studied the Operating Instructions, please contact your dental depot.

## 1.4 Scope of these Operating Instructions

### System versions

These operating instructions apply to the following treatment centers:

- Sinius (Dentist element with sliding track)
- Sinius CS (Dentist element with swivel arms)
- Sinius TS (Dentist element as OTP system)

### Equipment options

This document describes the full version of your system. It may therefore cover components that are not included in the system you purchased.

### Firmware

This document is valid for systems with software versions from:

#### Version 2.2

The current software version is displayed in the setup, see "Opening Setup programs" [→ 191].

## 1.5 Other valid documents

Your treatment center can be equipped with additional components that are described in separate instructions for use. The instructions as well as all warning and safety notices they contain must also be followed.

There is a separate set of instructions for use for each of the following components:

- Treatment instruments
- Satalec Acteon curing light Mini L.E.D.
- LEDview Plus operating light
- 22" monitor DC model 2017

- Heliodont Plus X-ray tube unit
- Hugo, Theo, Carl and Paul dental working stools

The document "Installation Requirements" is also available. It contains detailed technical specifications, dimension sheets, and information about operating the treatment center with regard to electromagnetic compatibility.

## 1.6 Warranty and liability

### Maintenance

Maintenance must be performed at scheduled intervals to ensure the operational and functional reliability of your product and to protect the safety and health of patients, users and other persons. For more information, please refer to "Maintenance by the service engineer" [→ 280].

The owner is responsible for making sure that all maintenance activities are performed.

As manufacturers of medical electrical equipment, we can assume responsibility for the safety properties of the unit only if maintenance and repairs on the unit are performed either by us or by agencies which we have expressly authorized and if components of the unit are replaced by original spare parts in case of failure.

### Exclusion of liability

In the event that the system owner fails to fulfill its obligation to perform maintenance activities or ignores error messages, Dentsply Sirona or your authorized dealer cannot assume any liability for any damage thus incurred.

## 1.7 Intended use

This dental treatment center is intended for use on humans in the area of dentistry and may only be used by trained dental professionals.

Contraindications for the use of the treatment center, if any, are listed in the individual sections, e.g. Treatment instruments.

This unit is not intended for operation in areas subject to explosion hazards.

This unit is permanently installed. Operation is not permitted in mobile vehicles.

Intended use also includes compliance with these instructions for use.

## 1.8 Obligation to notify authorities

In the European Union, the operator or user must report all serious events related to medical devices to the competent authority of the Member State in which he or she is established.

## 1.9 Formats and symbols used

The formats and symbols used in this document have the following meaning:

✓ Prerequisite 1. First action step 2. Second action step or ➤ Alternative action ↵ Result ➤ Individual action step	Requests you to do something.
See "Formats and symbols used [→ 13]"	Identifies a reference to another text passage and specifies its page number.
• List	Designates a list.
"Command / menu item"	Indicates commands / menu items or quotations.

## 2 Safety instructions

### 2.1 Identification of the danger levels

To prevent personal injury and material damage, please observe the warning and safety information provided in these instructions for use. Such information is highlighted as follows:

#### **DANGER**

An imminent danger that could result in serious bodily injury or death.

#### **WARNING**

A possibly dangerous situation that could result in serious bodily injury or death.

#### **CAUTION**

A possibly dangerous situation that could result in slight bodily injury.

#### **NOTE**

A possibly harmful situation which could lead to damage of the product or an object in its environment.

#### **IMPORTANT**

Application instructions and other important information.

**Tip:** Information for simplifying work.

### 2.2 Information on the unit

#### Accompanying documents



This symbol can be found next to the rating plate on the unit.

Meaning: Observe the Operating Instructions when operating the unit.



This symbol can be found on the rating plate on the unit.

Meaning: The accompanying documents are available on the manufacturer's homepage.

#### Electrostatic discharge (ESD)



Connector pins or sockets bearing ESD warning labels must not be touched or interconnected without ESD protective measures. See also 'Electrostatic discharge' and 'Electromagnetic compatibility' [→ 18].

### 2.3 On-site installation

The on-site installation must have been performed according to our requirements. The details are described in the document "Installation Requirements".

## 2.4 Installation of the treatment center

Installation must be carried out by authorized personnel according to the installation instructions.

## 2.5 Media quality

The air and water supplies must meet the requirements specified in the installation requirements.

To ensure compliance with the medical and national legal requirements for water from treatment centers, Dentsply Sirona recommends equipping the treatment center with a disinfection system. If you decide to operate the treatment center without a disinfection system, you must make alternative arrangements to ensure good water quality.

**As the operator of the treatment center, you are generally responsible for the water quality.**

The bacterial count must comply with the national regulations for drinking water and must not exceed 500 CFU/ml under any circumstances (CFU: colony forming unit).

If the bacterial count is too high, the building water system must be checked and the cause of contamination eliminated. It may be necessary to install an external system for self-contained water supply or reprocessing of the process water. Alternatively, if the treatment center is equipped with a disinfection system, the empty disinfectant tank can be used as a water tank for a self-contained water supply.

Before installation of the treatment center, an acceptable microbiological water quality for the domestic water supply must be ensured and documented in the form of the bacterial count. Sampling and bacterial counts should be performed by a competent laboratory.

Test the water quality from the treatment center at regular intervals and after it has not been used for >1 week, see "Microbiological water test" [→ 204]. Please contact your specialized dealer or your dental association for the respective national requirements and measures. Where necessary, you must make alternative arrangements to ensure good water quality if you decide to operate the treatment center without a disinfection system.

**Highly immunosuppressed patients or patients with specific pulmonary diseases should not come in contact with the water of the treatment unit. The use of sterile solutions is recommended.**

## 2.6 Connection to the public drinking water system

### Treatment center with isolation from public drinking water supply

Provided it is equipped with a disinfection system, the treatment center fulfills the requirements of EN 1717 (free outlet with isolating distance  $\geq 20$  mm) and the German Gas and Water Association (DVGW). It is intrinsically safe in accordance with worksheet W540 and therefore fulfills, among others, the W270 requirements as well as the requirements for plastics used in the transport of drinking water. It can be connected directly to the public drinking water supply.



The treatment center therefore also bears the symbol for the German Gas and Water Association (DVGW) along with the rating plate.

#### **Treatment center without isolation from public drinking water supply**

If compliance with EN 1717 is stipulated nationally, appropriate equipment must be installed beyond the treatment center to protect the public drinking water system.

This applies to device versions without a disinfection system.

The treatment center then does not bear the DVGW label.

Always adhere to the national requirements with regard to connecting treatment centers to the public drinking water supply.

## 2.7 Maintenance and repair

### **Authorized technical personnel and spare parts**

As manufacturers of dental medical units and in the interest of the operational safety of your system, we stress the importance of having maintenance and repair of this unit performed only by ourselves or by agencies expressly authorized by us. Furthermore, faulty components must always be replaced with original spare parts.

We suggest that you request a certificate showing the nature and extent of the work performed from those who carry out such work; it must contain any changes in rated parameters or working ranges (if applicable), as well as the date, the name of the company and a signature.

### **Maintenance intervals**

Despite the outstanding quality of your treatment center and regular care by the practice team, in the interest of operational safety, it is essential to have preventive maintenance performed at scheduled intervals.

In order to ensure the operational safety and reliability of your treatment center and to avoid damage due to natural wear, as the system owner you must have your system checked regularly by an authorized service technician from your dental depot. Furthermore, safety checks must be performed. Please contact your dental depot to obtain a maintenance offer. For more information, please refer to "Maintenance by the service engineer" [-> 280].

## 2.8 Trouble-free operation

This unit may only be used in proper working condition. If trouble-free operation cannot be ensured, e.g., due to malfunctions, noticeable or different noises, or damage, the unit must be taken out of service, checked by authorized technicians for malfunctions and, if necessary, repaired or replaced.

## 2.9 Vacuum system

The suction removal of aluminum and other metal oxides from blasting devices via the amalgam separator and the automatic separator installed in the treatment center is prohibited! This would cause extreme wear and clogging of the suction and water lines. A separate vacuum



system must be used in connection with metal oxide blasting devices. Otherwise, only water soluble blasting material may be used.

Treatment centers equipped with a central standard wet suction are generally suitable for suction removal of the above material. However, make sure to observe the instructions provided by the manufacturer of your suction system.

No restrictions apply when using salt blasting devices in connection with Dentsply Sirona treatment centers. However, in such cases, make sure that the system is subsequently flushed with an adequate amount of water.

## 2.10 Patient chair

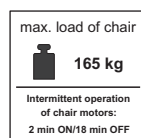

Please observe the maximum load capacity of 165 kg (363.8 lbs) for the patient chair.

The permissible maximum load capacity is indicated on a plate next to the rating plate of the treatment center.

The weight distribution complies with ISO 6875. The mechanical stability is tested with a multiple safety factor acc. to IEC 60601-1.

The maximum permissible weight of accessories mounted on the patient chair is 5 kg (11 lbs)

**The patient's arms and legs must be resting on the upholstery of the chair.**

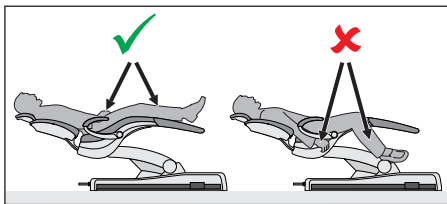

## 2.11 Intermittent operation

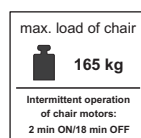

The motors of the treatment center and of the treatment instruments are designed for intermittent operation corresponding to the dental mode of treatment.

Drive motors for patient chair and backrest: max. 10% duty cycle, (max. 2 min "ON" / 18 min "OFF")

## 2.12 Ventilation slots

Under no circumstances may the ventilation slots on the unit be covered, since otherwise the air circulation will be obstructed. This can cause the unit to overheat.

Do not spray liquids such as disinfectants into the ventilation slots. This may lead to malfunctions. Only wipe to disinfect these areas.



## 2.13 Touchscreen

The monitor of the dentist element is equipped with touch-sensitive control technology.

The touchscreen must not be operated with pointed objects such as ball-point pens, pencils, etc. Such objects could damage or scratch its surface. Always operate the touchscreen by pressing it gently with your fingertip.

## 2.14 Care, cleaning, and disinfecting agents

Unsuitable care and cleaning agents or disinfectants may corrode the surface of the unit or impair its functioning.

Therefore, use only care and cleaning agents and disinfectants which have been approved by the manufacturer. For more information, see the chapter "Care, cleaning, and disinfecting agents" [→ 204].

## 2.15 Care and cleaning instructions for the practice team

Inappropriate care and cleaning of the device can result in failure or damage. Technical personnel must be trained in the handling of medical devices.

## 2.16 Modifications and extensions of the system

For reasons of product safety, this product may be operated only with original parts or third-party parts expressly approved by Dentsply Sirona. In the event of unintended modifications, Dentsply Sirona is not liable for resulting damages.

All units connected to this product must comply with the applicable standards:

- IEC 60601-1, Medical electrical equipment
- IEC 60950-1, Information technology equipment
- IEC 62368-1, Audio/video, information and communication technology equipment

## 2.17 Electromagnetic compatibility



Medical electrical devices are subject to special precautionary measures with regard to electromagnetic compatibility (EMC). They must be installed and operated as specified in the document "Installation requirements".

Portable HF communication equipment, including accessories, should not be used in the vicinity of the device. Non-observance can impair the performance features of the device.

### Operating an HF surgical device

Treatment with HF surgical devices creates strong electromagnetic fields, which may affect other electronic devices. Do not place external HF surgical devices on the work surfaces of the treatment center and do

not guide the HF handpiece cable over it. Electromagnetic interference can often be reduced by operating the external HF surgical device with a neutral electrode.

### Sivision Digital and USB interface

The presence of electromagnetic interference in the vicinity of the treatment center may cause image interference and interruptions in the data transmission via the USB interface to the PC. In such cases, repeat the image recording or other operations.

In the event of strong interference, it may be necessary to restart the PC and treatment center. Therefore, do not use the PC for controlling other devices that perform essential tasks.

### Wireless foot control

The wireless foot control may interfere with other devices in the same frequency band (2.4 GHz) or receive interfering signals from them. The safe condition of the treatment center is guaranteed even if the wireless transmission is compromised.

## 2.18 Electrostatic discharge

### Protective measures

Electrostatic discharge (abbreviated: ESD – **ElectroStatic Discharge**)

Electrostatic discharge from people can damage electronic components when the components are touched. Damaged components usually have to be replaced. Repairs must be performed by qualified personnel.

Measures to protect against ESD include:

- Procedures to avoid electrostatic charging via
  - air conditioning
  - air humidification
  - conductive floor coverings
  - non-synthetic clothing
- Discharging the electrostatic charges from your own body through contact with
  - a metallic unit casing
  - a larger metallic object
  - any other metal part grounded with the protective earth
- Wearing an antistatic band that creates a connection between the body and a protective ground wire.

Areas at risk are indicated on the unit with the ESD warning label:

We recommend that all persons working with this system are made aware of the significance of the ESD warning label. A training course should also be held to inform users about the physics of electrostatic charges.

### Physics of electrostatic charges

An electrostatic discharge requires prior electrostatic charging.

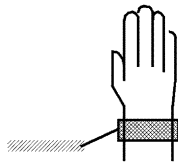
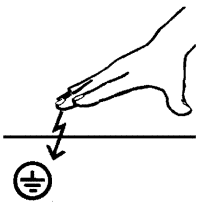

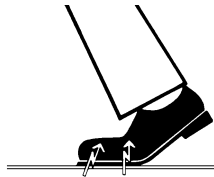

There is a danger of electrostatic charges building up whenever two bodies rub against each other, e.g. when:

- walking (soles of shoes against the floor) or
- moving (chair casters against floor).

The amount of charge depends on several factors: The charge is:

- higher at low air humidity than at high air humidity, and
- higher with synthetic materials than with natural materials (clothing, floor coverings).

The following rule of thumb can be applied to assess the transient voltages resulting from an electrostatic discharge.

An electrostatic discharge is:

- perceptible at 3,000 V or higher
- audible at 5,000 V or higher (cracking, crackling)
- visible at 10,000 V or higher (arc-over)

The transient currents resulting from these discharges have a magnitude of over 10 amps. They are not hazardous for humans because they last for only several nanoseconds.

**Tip:** 1 nanosecond= 1/1,000,000,000 second= 1 billionth of a second

Voltage differentials exceeding 30,000 volts per centimeter may lead to a charge transfer (electrostatic discharge, lightning, spark-over).

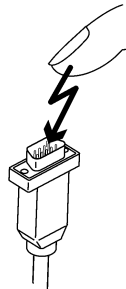

Integrated circuits (logical circuits and microprocessors) are used in order to implement a wide variety of functions in a device. The circuits must be miniaturized to a very high degree in order to include as many functions as possible on these chips. This leads to structure thicknesses as low as a few ten thousandths of a millimeter. Integrated circuits that are connected to wires leading externally are therefore particularly at risk from electrostatic discharge.

Even voltages that are imperceptible to the user can cause breakdown of the structures, thus leading to a discharge current that melts the chip in the affected areas. Damage to individual integrated circuits may cause malfunction or failure of the unit.

## 2.19 Dismantling/Installation

When dismantling and reinstalling the unit, proceed according to the installation instructions for new installation in order to guarantee its functioning, stability and safety.

## 2.20 Operating environment

The treatment center is not suitable for use in the presence of anesthetics that are flammable when in contact with air, oxygen or nitrous oxide (laughing gas).

## 3 Unit description

### 3.1 Standards/Approvals

The Sinius treatment center complies with the following standards, among others:

- IEC 60601-1 (electrical and mechanical safety plus software reliability)
- IEC 60601-1-2 (electromagnetic compatibility)
- IEC 60601-1-6 / IEC 62366 (usability)
- IEC 62304 (software process)
- ISO 6875 (patient chair)
- ISO 7494-1 (dental treatment devices)
- ISO 7494-2 (dental treatment devices, water and air supply)
- ISO 9680 (operating light)
- ISO 11143 (amalgam separator), see also below (provided amalgam separator option is available)
- EN 1717 (connection to the drinking water system), see also below and chapter "Connection to the public drinking water supply" [→ 15]

Original language of this document: German



This product bears the CE marking in accordance with the provisions of Council Directive 93/42/EEC of June 14, 1993 concerning medical devices.

The treatment center complies with the requirements of the RoHS Directive 2011/65/EU.



The treatment center meets the requirements of CAN/CSA-C22.2 No. 60601-1 And AAMI/ANSI ES 60601-1.



The amalgam separator achieves a separation efficiency of > 95%. The unit thus fulfills the requirements of ISO 11143.

Separating procedure type 1: Centrifuge system

The amalgam separator is approved by the German Institute for Building Technology (DIBt).



When equipped with a disinfection system, the treatment center complies with the technical rules and requirements on safety and hygiene for connection to the public drinking water supply. The unit is certified according to the requirements of the German Technical and Scientific Association for Gas and Water (DVGW). It is intrinsically safe in accordance with worksheet W540. The unit thus also meets the requirements of standard EN 1717; see also the chapter entitled "Connection to the public drinking water system" [→ 15].



This unit meets the requirements of BELGAQUA and may therefore be connected to the public drinking water supply in Belgium.



This unit meets the requirements of ATS and may therefore be connected to the public drinking water supply in Australia.



The wireless modules in the wireless foot control and in the treatment center meet the requirements of the RED Directive 2014/53/EU.

Standards:

- EN 60950-1, EN 62311
- EN 301489-1, EN 301489-17, EN 300328



The modules meet the requirements of the Federal Communications Commission (Part 15 of the FCC Rules).



FCC ID: RFRMS

**Industry Canada**

The modules meet the requirements of Industry Canada (RSS210).

IC: 4957A-MS

## 3.2 Technical data

Model designation:	Sinius / Sinius CS / Sinius TS
Power connection:	100 – 240 V AC $\pm$ 10% 50/60 Hz
Rated current:	2.2 A at 240 V 4.35 A at 115 V 5.0 A at 100 V also max. 6 A for external devices
Type of ground connection:	TN-C-S system or TN-S system (acc. to IEC 60364-1)
Overvoltage category:	2 acc. to IEC 60664-1
Average power consumption (for dimensioning an air conditioning system):	0.25 kW
Power consumption in the Standby mode:	3 W (without internal mini PC)
Main building fuse:	Type B automatic circuit breaker 100 - 115 VAC: 20 A medium-blow 220 – 240 V AC: 16 A medium-blow
Protection class:	Class I device
Device class in accordance with Directive 93/42/EEC:	Class IIa equipment
Degree of protection against electrical shock:	 Type B applied parts External intraoral camera SiroCam AF / AF+. These are:
	 Applied part type BF
Degree of protection against ingress of water:	Ordinary equipment (without protection against ingress of water) The foot switch has an IPX1 degree of protection against liquids (drip-proof).
Mode of operation	Continuous operation with intermittent loading corresponding to the dental mode of working. [→ 17] Drive motors for chair operation: intermittent use, max. 2 minutes on and 18 minutes off Permanently connected unit. Operation is not permitted in mobile vehicles.

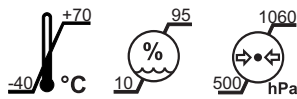

Transport and storage conditions:

Temperature: -40 °C – +70 °C  
(-40 °F – 158 °F)

Relative humidity: 10% – 95%

Air pressure: 500 hPa – 1060 hPa

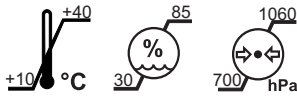

Operating conditions:

Ambient temperature: 10 °C – 40 °C  
(50 °F – 104 °F)

Relative humidity: 30% – 85%  
without condensation

Air pressure: 700 hPa – 1060 hPa

Installation location:

≤ 3000 m above sea level

This treatment center is not suitable for operation in areas subject to explosion hazards.

Pollution degree:

2 acc. to IEC 60664-1

Tests/Approvals:

See "Standards/Approvals" [→ 21].

Date of manufacture:



**20yy-mm-dd**

(on the rating plate)

Ethernet interface:

corresponds to 10/100 BASE-T standard

USB interface:

corresponds to USB 2.0 standard

### Foot control wireless interface

Model designation: BlueMod+S

Frequency: 2.4 GHz – 2,480 GHz

Transmitting power: < 2 mW (short-range device)

Modulation type: GFSK

Range: approx. 10 m

Approval: See "Standards/Approvals" [→ 21].

### IMPORTANT

#### Minimum requirements for the PC

See document "Installation instructions and system requirements for PC configuration," (REF 6194075) Sivision Digital.



### 3.3 System overview

The Sinius, Sinius CS, and Sinius TS treatment centers comprise the following main components:

#### Sinius treatment center (sliding track device)

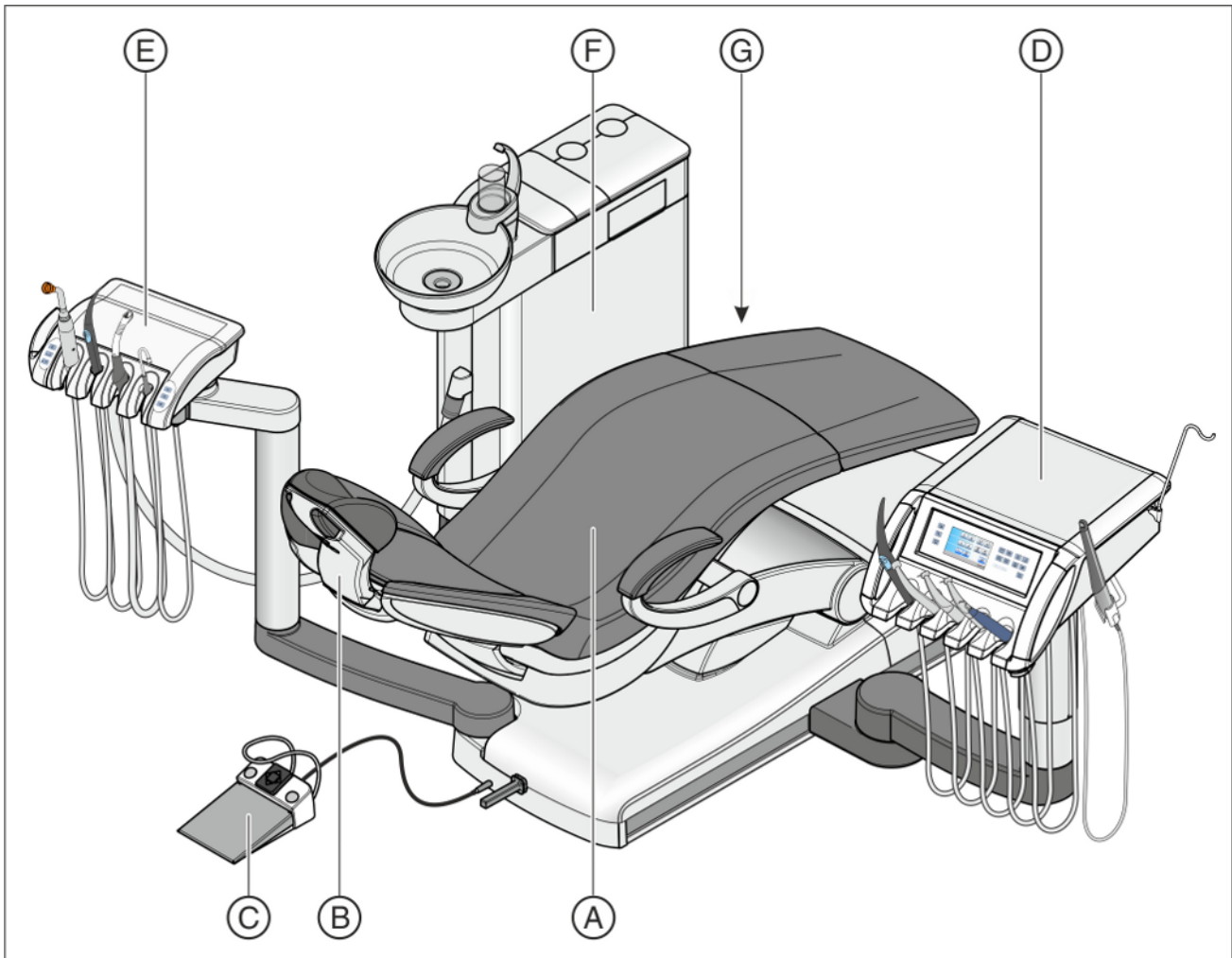

A	Patient chair [→ 28]
B	Motor-driven headrest [→ 29] (shown here) or Double articulating headrest [→ 30]
C	Foot control [→ 31] (with cable or wireless link)
D	Sinius dentist element on the sliding track [→ 32]
E	Assistant element [→ 42]
F	Water unit [→ 45]
G	External device connection [→ 47] and power switch

Sinus CS treatment center (swivel arm unit)

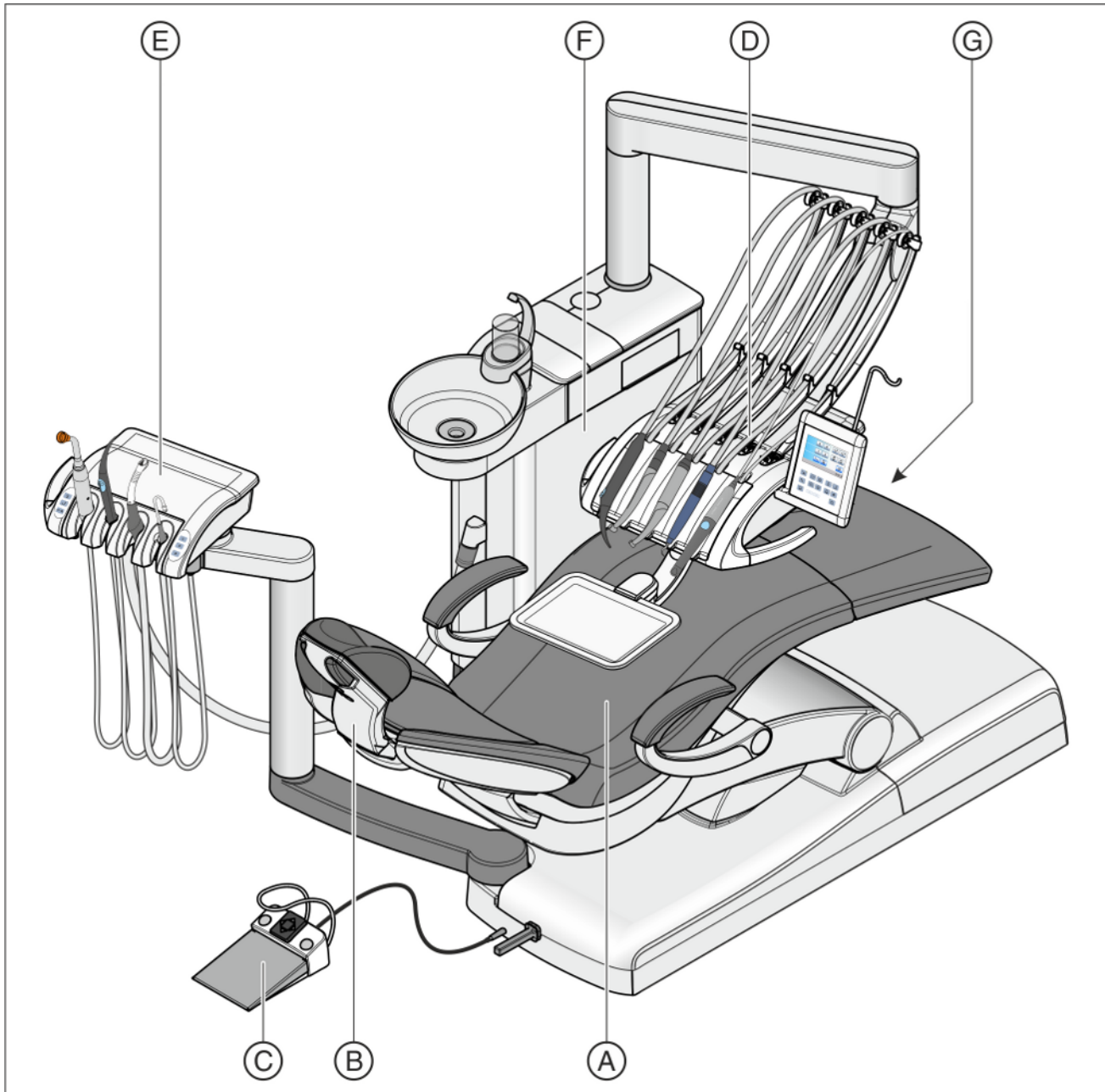

A	Patient chair [→ 28]
B	Motor-driven headrest [→ 29] (shown here) or Double articulating headrest [→ 30]
C	Foot control [→ 31] (with cable or wireless link)
D	Dentist element Sinus CS with swivel arms [→ 32]
E	Assistant element [→ 42]
F	Water unit [→ 45]
G	External device connection [→ 47] and power switch

Sinus TS treatment center (OTP unit)

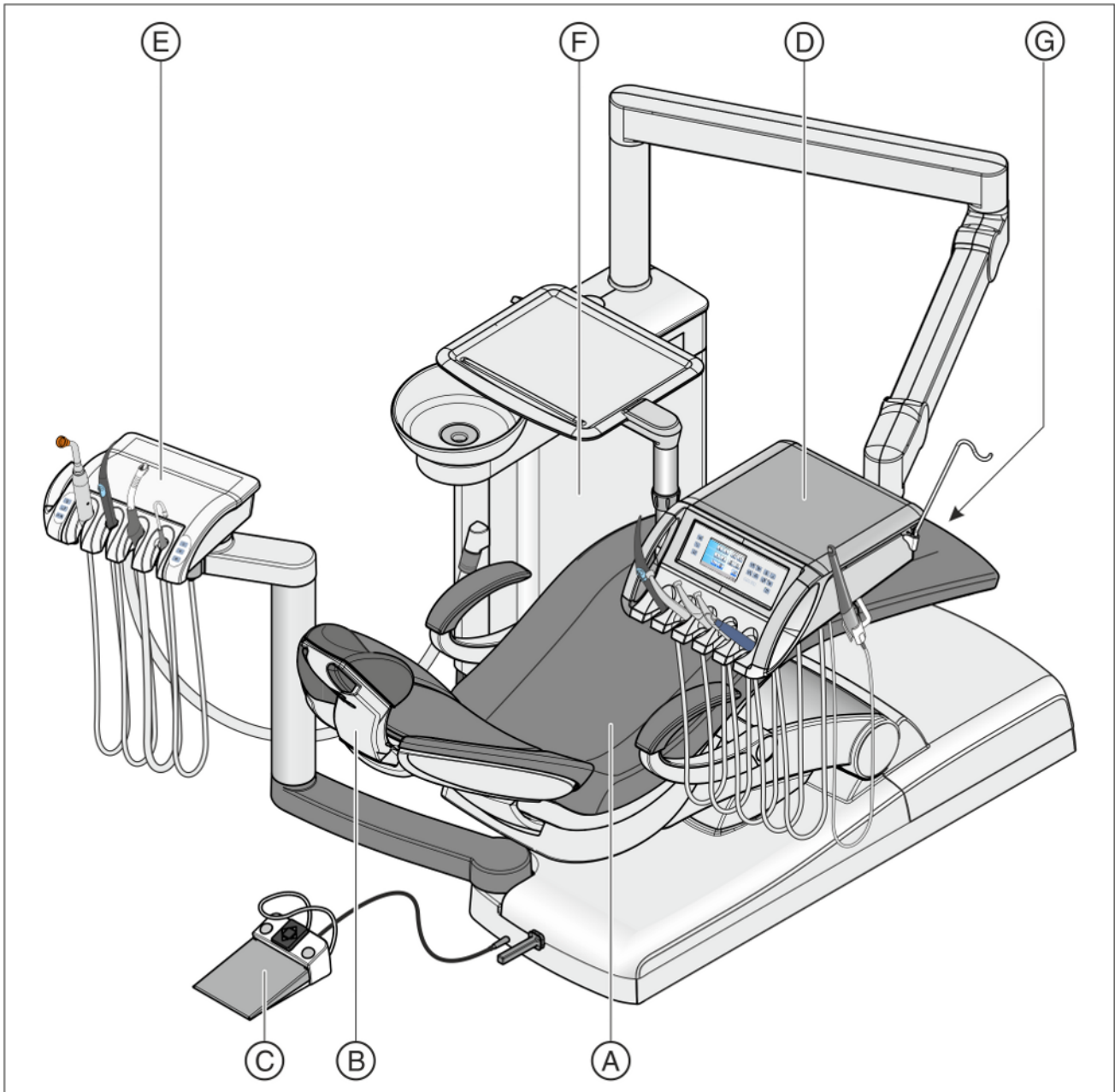

A	Patient chair [→ 28]
B	Motor-driven headrest [→ 29] (shown here) or Double articulating headrest [→ 30]
C	Foot control [→ 31] (with cable or wireless link)
D	Sinus TS dentist element as OTP system [→ 32]
E	Assistant element [→ 42]
F	Water unit [→ 45]
G	External device connection [→ 47] and power switch

### 3.4 Patient chair

The patient chair features a variety of adjustment options to optimally adapt the patient's position for the given treatment.

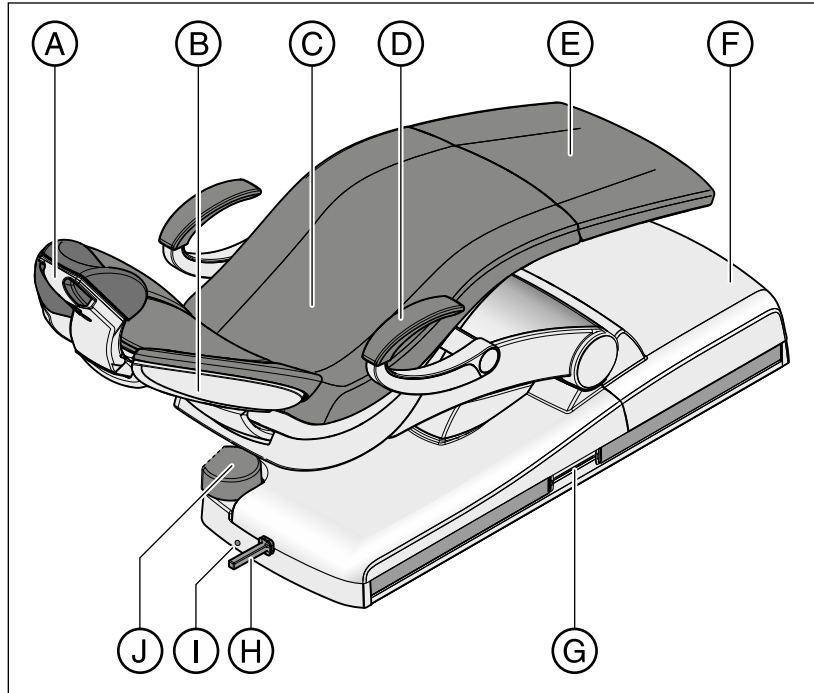

A	Motor-driven headrest (shown here) or articulating headrest
B	Backrest
C	Seat
D	Armrest
E	Footrest
F	Chair base
G	Flange on the Sinuis dentist element sliding track
H	4-way foot switch
I	Foot control cable port
J	Rotary joint for assistant element

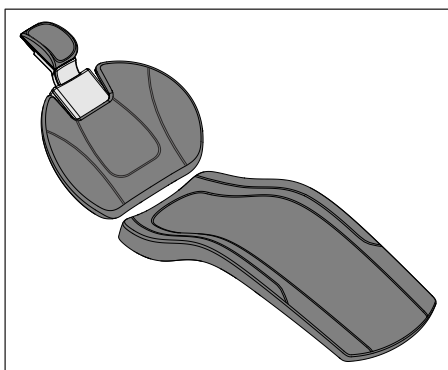

The patient chair can come with lounge upholstery featuring enhanced comfort and double seams. The lounge upholstery has no footrest; the surface is padded throughout.

## 3.5 Headrest

### 3.5.1 Motor-driven headrest

The headrest allows for the following adjustment options:

- Motor-driven extension/retraction to adapt to the patient's stature
- Motor-driven tilting for maxillary/mandibular treatment
- Manual tilting via quick mechanical adjustment
- Shifting/rotation of the head support via the magnetic holder

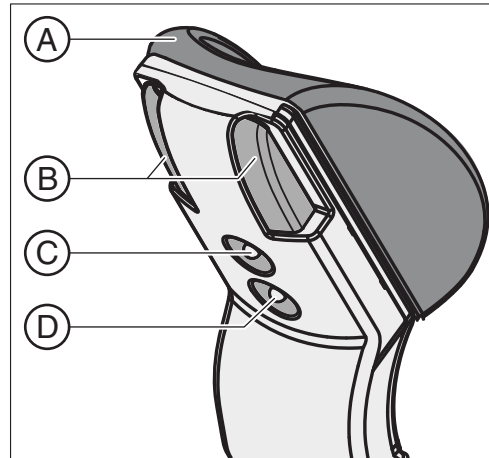

A	Removable head pad with magnetic holder
B	Quick mechanical adjustment of headrest tilt
C	Upper 4-way switch for headrest functions
D	Lower 4-way switch for chair functions

For details, see "Adjusting the motor-driven headrest" [-> 67].

### 3.5.2 Double-jointed head support

The double articulating headrest is equipped with two rotary joints. They allow the head inclination to be manually adjusted over a wide range for maxillary/mandibular treatment. The headrest extension can be pushed in or pulled out to manually adjust it to the height of the patient.

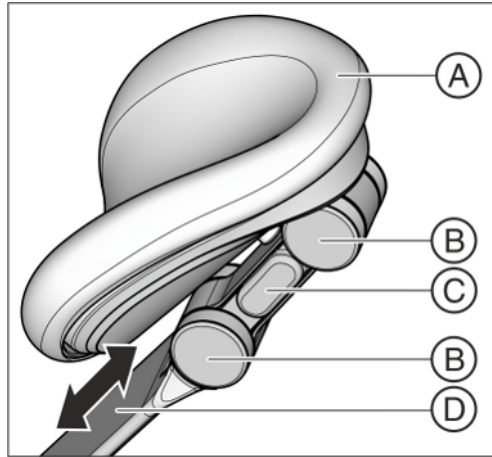

A	Head pad
B	Rotary joints
C	Unlock button (one-sided)
D	Support bar for adjustment to patient height

For details, see "Adjusting the double articulating headrest." [→ 69]

### 3.6 Foot control

The foot control enables hand-free control of the treatment instruments. Via the integrated cursor control, virtually all functions of the treatment center can be controlled via the foot control as an alternative to hand control.

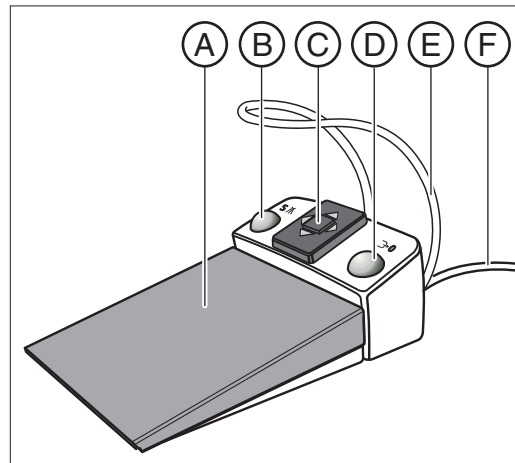

A	Foot pedal as speed foot control or direct starter
B	Left button (program key S or spray)
C	4-way foot control plate for cursor control
D	Right button (program key 0 or chip blower)
E	Positioning bar
F	Connecting cable

The foot control is also available with wireless transmission. The connecting cable has been omitted for the wireless foot control. The power supply is provided by a battery, see "Changing the battery of the wireless foot control" [→ 277].

### 3.7 Dentist element

All functions of the treatment center can be controlled via the **EasyTouch** control panel on the dentist element. The treatment center can be fitted with the following dentist elements:

These instructions for use are valid for the following treatment centers:

- Sinus (Dentist element with sliding track)
- Sinus CS (Dentist element with swivel arms)
- Sinus TS (Dentist element as OTP system)

#### Sinus dentist element

The dentist element can be moved the entire length of the patient chair along the sliding track. In combination with the rotary joints on the support arm, the dentist element can be perfectly adjusted to suit any treatment.

With this dentist element, instruments are placed in the instrument holders in an upright position. The instrument hoses hang freely under the dentist element.

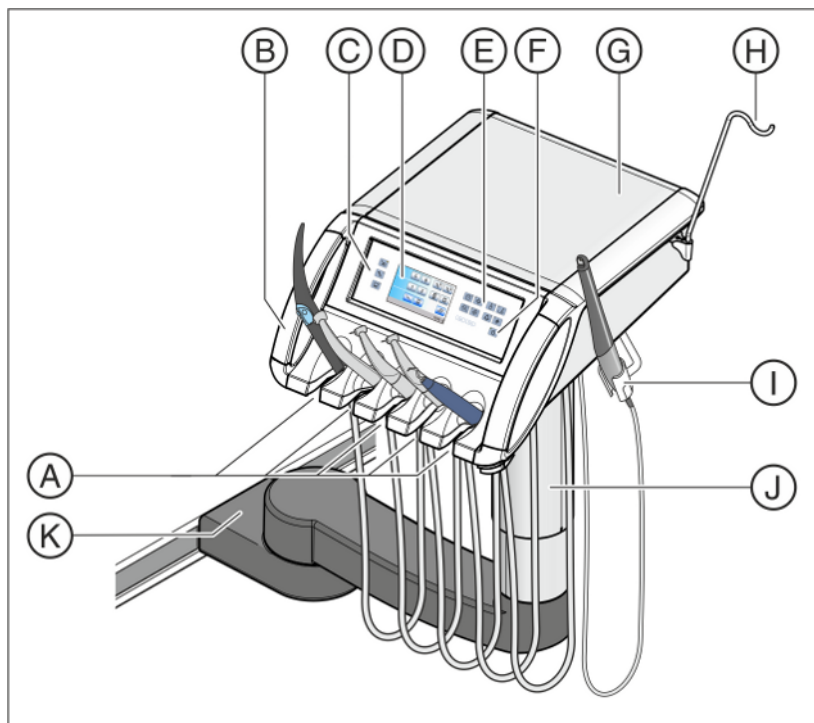

A	Removable instrument holder (max. 5 instruments)
B	Removable handles (left/right)
C	Dialog change keys
D	Touchscreen for display and operation
E	Fixed keys
F	Standby switch
G	Skid-proof silicone mat
H	Removable NaCl bottle holder



I	Additional holder for intraoral camera
J	Support arm, height adjustable by service technician
K	Slide of sliding track

### Sinus CS dentist element

The Sinus CS dentist element is attached to the water unit with a flexible support arm. The dentist element is held in place at the adjusted height with a pneumatic locking brake in the support arm. To release the brake simply touch one of the two handles.

With this dentist element, instruments are placed in the instrument holders horizontally and facing downwards. The instrument hoses are placed above the dentist element over the swivel arm.

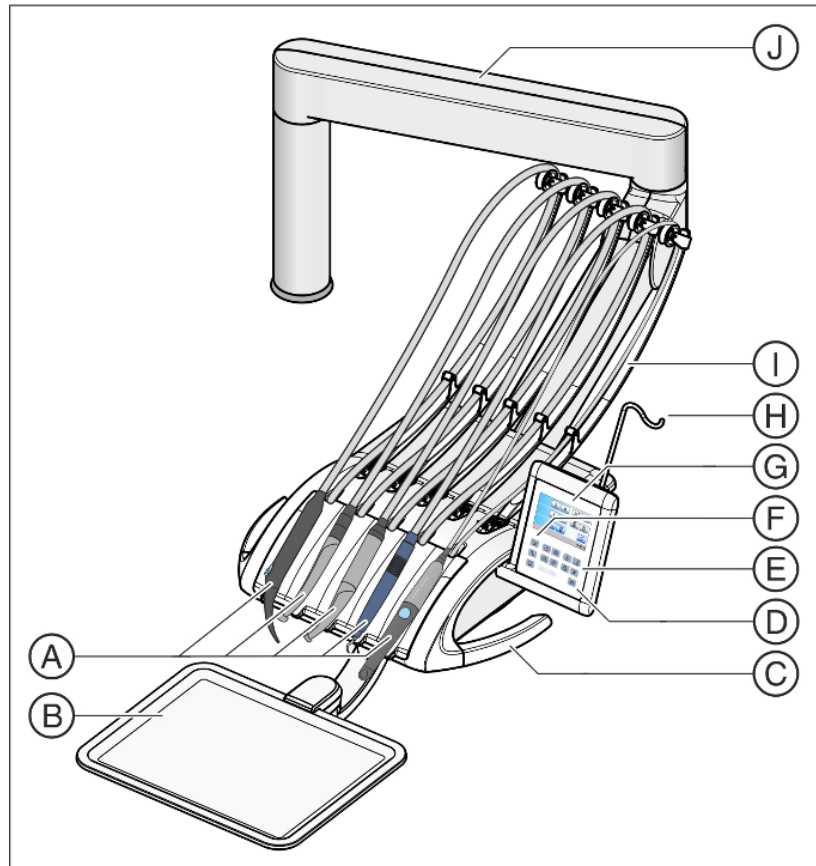

A	Removable instrument holder (max. 5 instruments)
B	Tray on the dentist element
C	Handles (left/right) with integrated switch for releasing the support arm brake
D	Standby switch
E	Fixed keys
F	Dialog change keys
G	Touchscreen for display and operation
H	Removable NaCl bottle holder
I	Swivel arms
J	Support arm

### Sinius TS dentist element

The Sinius TS dentist element is attached to the water unit with a flexible support arm. The dentist element is held in place at the adjusted height with a pneumatic locking brake in the support arm. To release the brake simply touch one of the two handles in the upper area.

With this dentist element, instruments are placed in the instrument holders in an upright position. The instrument hoses hang freely under the dentist element.

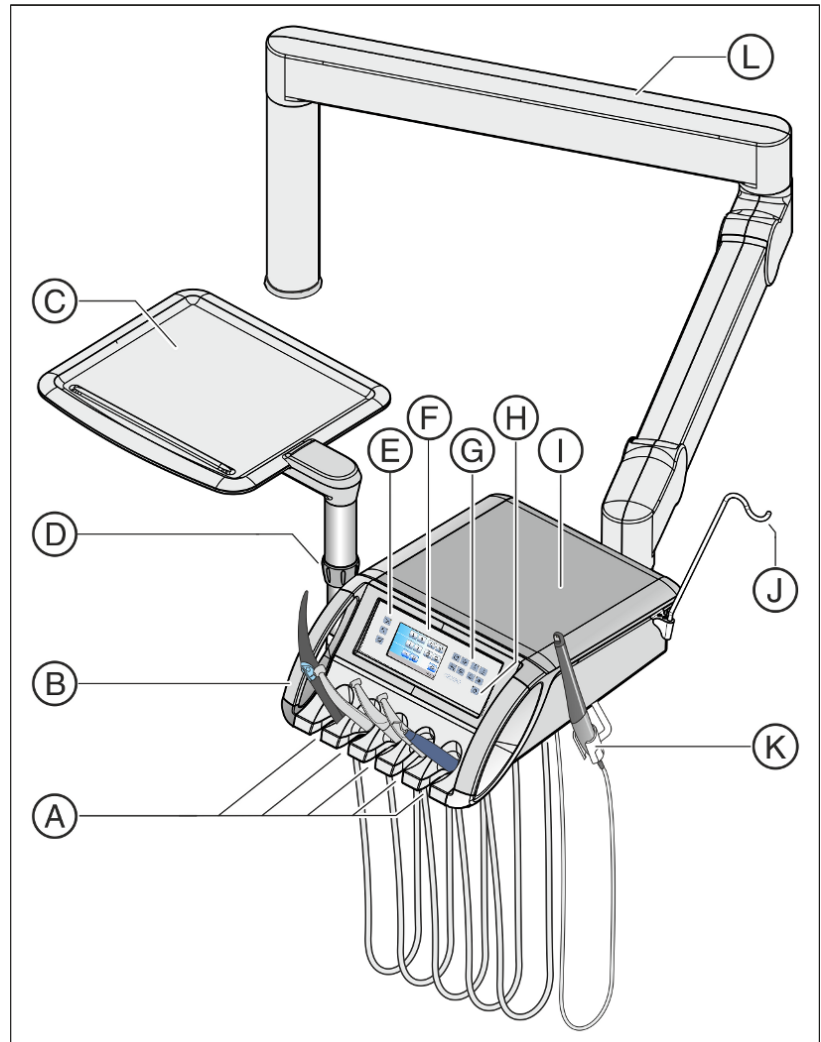

A	Removable instrument holder (max. 5 instruments)
B	Handles (left/right) with integrated switch for releasing the support arm brake
C	Tray on the dentist element
D	Locknut for setting tray height
E	Dialog change keys
F	Touchscreen for display and operation
G	Fixed keys

H	Standby switch
I	Skid-proof silicone mat
J	Removable NaCl bottle holder
K	Additional holder for intraoral camera
L	Support arm

### 3.7.1 Instrument positions

The following instrument position assignments are possible:

Holder 1	Holder 2	Holder 3	Holder 4	Holder 5	Additional holder <sup>2</sup>
Multifunctional syringe Sprayvit M	Motor: • BL • BL ISO E • BL ISO C • BL Implant	Motor: • BL • BL ISO E • BL ISO C • BL Implant	Motor: • BL • BL ISO E • BL ISO C • BL Implant	SiroSonic TL <sup>1</sup> scaler	SiroCam AF or SiroCam AF+ intraoral camera
	Turbine	Turbine	Turbine	SiroCam AF or SiroCam AF+ intraoral camera	
			SiroSonic TL <sup>1</sup> scaler		

<sup>1</sup> A maximum of one SiroSonic TL scaler can be connected.

<sup>2</sup> Only the Sinus and Sinus TS dentist elements can be equipped with an additional holder.

### 3.7.2 EasyTouch user interface

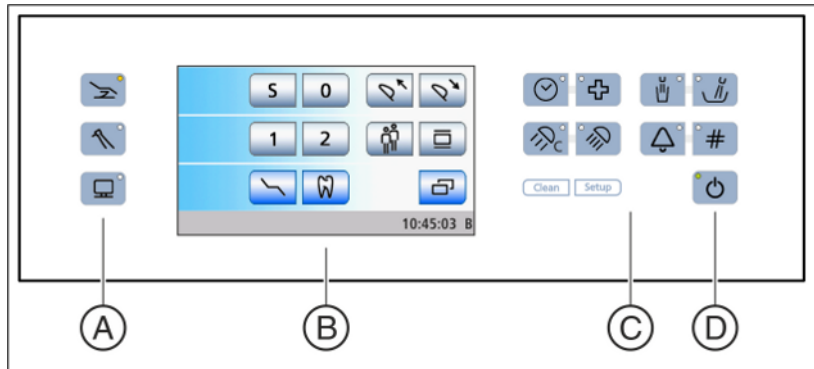

User interface of the Sinius and Sinius TS dentist element

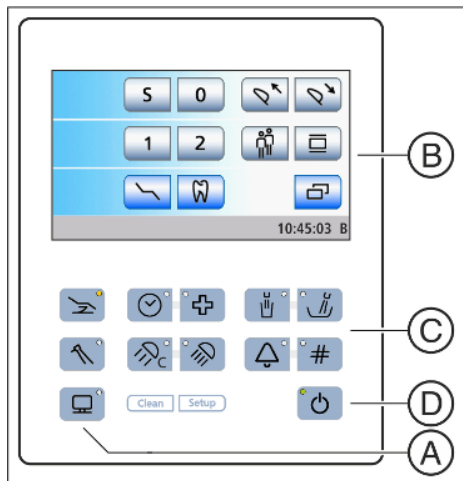

User interface of the Sinius CS dentist element

A	Fixed keys for opening the Start, Instrument or Sivation dialog (membrane keyboard)
B	Touch panel (pressure-sensitive user interface)
C	Fixed keys (membrane keyboard)
D	Standby switch

### 3.7.3 Touchscreen

The touchscreen displays virtual function keys according to the program selected. A list of all function keys is provided in the Appendix of this document, see "Overview of all function keys" [→ 290].

Some programs are divided into main programs and sub-screens. The main programs are briefly introduced below:

#### Start dialog

The Start dialog can be displayed in the *Standard Start dialog* or *EasyMode Start dialog* operating mode. For further details on both operating modes, see "Start dialog operating modes" [→ 53].



*Standard Start dialog (left) and EasyMode Start dialog (right)*

#### Instrument dialog

The *Standard Start dialog* operating mode displays the instrument dialog for the removed instrument. The instrument programs can be displayed either with the fixed quick adjustment keys, programmable quick adjustment keys, or via the function levels. For details, see "Quick setting keys and function levels." [→ 86]



*Motor dialog with fixed quick setting keys (left), programmable quick setting keys (center) and function levels (right)*

#### Sivision dialog

The Sivision dialog enables certain computer programs running on the PC to be controlled directly from the treatment center. For details, see "Operation with a PC" [→ 184].



*Sivision dialog for Sidexis 4 (left) and Sidexis XG (right)*

### 3.7.4 Fixed keys on the dentist element

For a more detailed description of the fixed key functions, see "Fixed keys on the dentist element" [→ 81].



#### Standby switch

Switches the treatment center on/off.

To switch off the treatment center, press and hold the key until an acoustic signal sounds. Then release the key.

#### IMPORTANT

##### Power switch

The treatment center also features a power switch on the base of the chair that separates the treatment center from the power supply, see "Switching the treatment center on/off" [→ 49].



#### Dialog change keys

The dialog change keys allow the user to switch between the main dialogs *Start dialog*, *Instrument dialog* and *Sivision dialog* in the *Standard start dialog* operating mode.



In the *EasyMode start dialog* operating mode, the dialog change keys *Chair* and *Instrument* can be used to switch to the relevant sub-dialogs.



#### Timer function

Opens the *Timer function* dialog where any of four preset timers can be activated. The elapsed time is displayed in the status bar of the touchscreen.

If the *Timer function* key is pressed (> 2 s), the settings dialog appears.



#### Shock positioning

Immediately moves the patient chair to a position for shock positioning of the patient.



#### Operating light

Switches the operating light on/off.

If the *Operating light* key is pressed for > 2 s, the settings dialog appears.



#### Composite function

Switches the composite function for the operating light on/off.

This function can delay the curing of composite materials.



#### Tumbler filling

Starts or stops the tumbler filling function.

When the *Tumbler filling* key is pressed (> 2 s), the filling time and water heating settings dialog appears.





#### **Cuspidor flushing**

Starts or stops cuspidor flushing.

When the *Flushing* key is pressed (> 2 s), the *Flushing Time* settings dialog appears.



#### **Freely selectable function**

e.g., call key

Freely available relay 230 VAC, 6 A  
(connected by the service engineer).

This function can be preset as a button or as a switch in the Setup dialog.



#### **Freely selectable function**

Freely available relay 230 VAC, 6 A  
(connected by the service engineer).

This function can be preset as a button or as a switch in the Setup dialog.



#### **Clean key**

Pressing this key deactivates the complete user interface of the dentist element with the exception of the standby switch. Pressing it again > 3 s reactivates the user interface.

This is used to make sure that no unwanted functions can be accidentally triggered while cleaning the surface.



#### **Setup key**

Used for individual configuration of the treatment center by the user and for reading out messages by the service technician, see "Configuration of the treatment center (Setup)" [→ 191].

### 3.8 Assistant element

The functional scope of the assistant element is adapted to the dental assistant's field of activity. It can, however, also be positioned so as to enable unassisted treatment by the dentist.

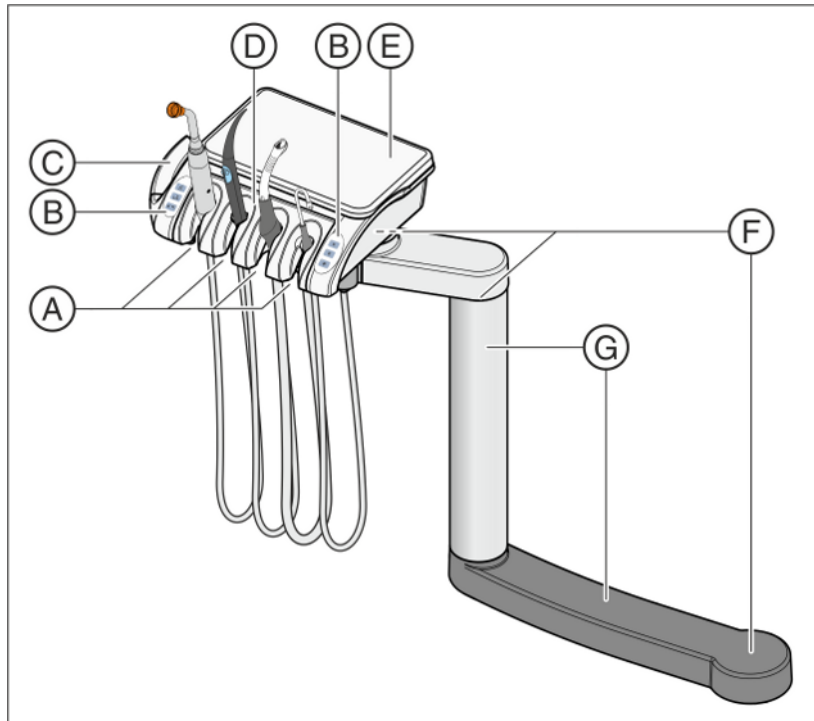

A	Holders 1 to 4 (from left to right) for instruments
B	User interfaces (left/right)
C	Removable handle
D	Removable instrument holder
E	Skid-proof silicone mat
F	3 rotary joints for flexible positioning
G	Support arm

### 3.8.1 Instrument positions

The following instrument position assignments are possible:

Holder 1	Holder 2	Holder 3	Holder 4
Mini L.E.D. curing light	Multifunctional syringe Sprayvit M	Spray aspirator	Saliva ejector
<sup>1</sup> SiroCam AF or SiroCam AF+ intraoral camera			
Second spray aspirator or saliva ejector for surgical suction			

<sup>1</sup> Only the Sinus CS and Sinus TS treatment centers can be equipped with an intraoral camera on the assistant element.

### 3.8.2 User interface

There are three fixed keys located on each side, to the left and right of the assistant element.

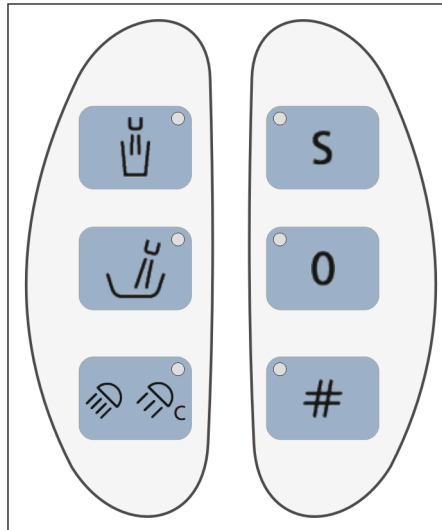

### 3.8.3 Fixed keys on the assistant element

For a more detailed description of the fixed key functions, see "Fixed keys on the assistant element" [-> 150].



#### **Tumbler filling**

On/Off

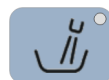

#### **Cuspidor flushing**

On/Off



#### **Operating light / Composite function**

Switches the operating light on, to the composite function, or off.

The composite function delays the curing of composite materials.

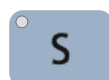

#### **Chair program S**

Mouth rinsing position with last-position memory function (programmable)

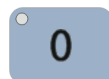

#### **Chair program 0**

Entry/exit position (programmable)



#### **Freely selectable function**

The *Hash* key on the assistant element can be configured in the Setup dialog. The key allows the user to switch the X-ray viewer or the white screen function on the Sivation monitor on or off or alternatively to activate the bell or hash relay.

Freely available relay 240 VAC, 6 A  
(connected by the technician)

## 3.9 Water unit

The water unit can be optionally equipped with a disinfection system. In normal operation, this will automatically inoculate the water that comes in contact with the patient (also called treatment water) with a disinfectant for the water lines. This leads to a decrease in bacterial growth and to the reduction of the bacteria in the water. Furthermore, the disinfection system can also be used to disinfect the water lines, see "Interactive sanitizing of the treatment center" [→ 264]. If you operate the treatment center without a disinfection system, please refer to the information in sections "Media quality" [→ 15] and "Standards/Approvals" [→ 21].



### WARNING

#### **Microorganisms can multiply in the water.**

These microorganisms could increase the risk of damage to one's health.

- If the treatment center is equipped with a disinfection system, never operate this to disinfect the water paths without disinfectant.

If the water unit is equipped with a disinfection system, it can be switched to operation with a self-contained water supply. After switching, distilled water must be mixed with the disinfectant for the water lines in a ratio of 100:1 (1 liter of water, 10 ml of the agent) and filled into the storage tank of the water unit, see "Self-contained water supply" [→ 162].

The water unit can be optionally equipped with an automatic separator (separation of suction air and waste water) combined with an amalgam separator/sediment container or with a standard wet suction.

Sanitization adapters for water-carrying instruments and adapters for suction hoses are integrated in removable cartridges in the top cover of the water unit. The dentist element and assistant element instruments are plugged into these adapters on both sides of the water unit. The openings are covered by flaps. The sanitization adapters are needed for sanitizing the treatment center and automatically purging the water lines (autopurge), the adapters for the suction hoses for suction hose cleaning.

To clean the suction system, water is pumped into a tank behind the suction hose intake and suctioned off from there. A cleaning agent is automatically added to the water if the treatment center is equipped with the chemical suction hose cleaning option. For more information, see "Cleaning the suction hoses" [→ 241].

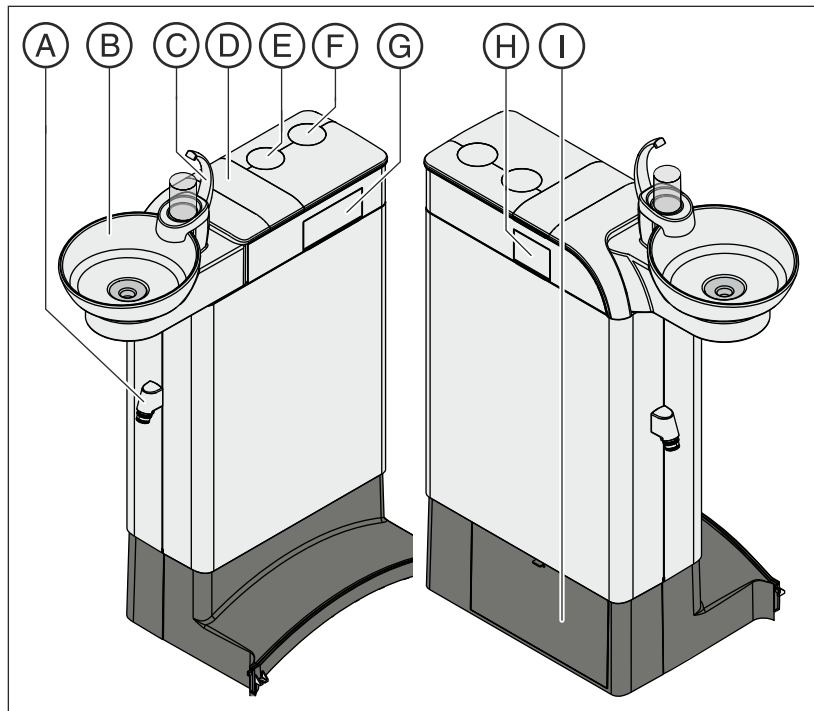

A	Suction hose connection for assistant element
B	Manually swiveling cuspidor
C	Tumbler filler (depicted) or Tumbler filler with automatic sensor control for automatic tumbler filling
D	Cover of the storage tank for the disinfectant for the water lines or for the self-contained water supply
E	Mount for support arm of the operating light and monitor
F	Mount for Sinus CS and Sinus TS dentist elements or tray support arm
G	Sanitization adapter for water-carrying instruments for conducting sanitization and autopurge
H	Adapters for the suction hoses to conduct suction hose cleaning
I	Maintenance flap for accessing the cleaning agent tank for chemical suction hose cleaning, the cuspidor flushing valve, the potentiometer of the automatic sensor control, the amalgam separator or sediment container, or filter insert for standard wet suction

### 3.10 External device connection

External medical additional devices can be connected to the external device connection. They must comply with the requirements of IEC 60601-1.

#### NOTE

**If the treatment center is equipped with a disinfection system, additional devices are exposed to a hydrogen peroxide concentration ((H<sub>2</sub>O<sub>2</sub>) of 0.1‰-0.2‰ at the external device connection.**

If the additional devices are not suitable for the specified hydrogen peroxide concentration, they may be damaged.

- > Before connecting any additional devices, check to make sure that they can be exposed to the above hydrogen peroxide concentration. Contact the manufacturer of the relevant additional device, if necessary.
- > Prior to sanitization, additional devices must be unplugged from the external device connection (water connection), see "Sanitization" [→ 264].

#### IMPORTANT

##### DVGW approval

As the treatment center is designed according to EN 1717/DIN 1988 (DVGW requirements), the connected additional devices also fulfill the requirements of the above standards when a disinfection system is integrated, see "Standards and approvals" [→ 21].

#### IMPORTANT

##### Self-contained power supply

The IEC socket remains live when the power switch is turned off. The connected external devices therefore must have their own power switch.

However, the air and water connections are switched off.

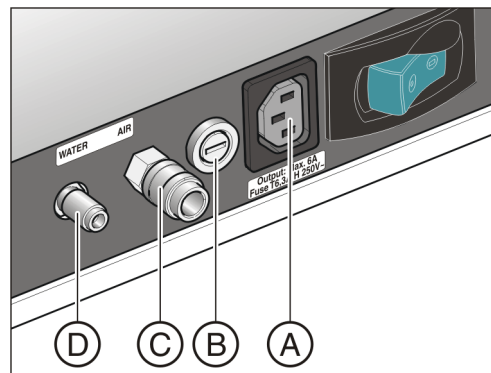

A	IEC outlet socket with power supply (max. 6 A)
B	Fuse for IEC outlet socket (6.3 A slow-blow)
C	Quick coupling for air
D	Quick coupling for water

	<b>Print</b>	<b>Flow rate</b>
Water	2.2 ± 0.2 bar	max. 300 ml/min
Air	4.4 ± 0.5 bar	max. 70 NI/min

**IMPORTANT**

Media removal at the external device connection can reduce the performance of integrated consumers, e.g., the filling quantity of the tumbler or the high-speed handpiece. Integrated consumers can also reduce the pressure at the external device connection.



## 4 Operation

### 4.1 Starting up the treatment center

#### 4.1.1 Initial startup

##### Sanitizing the water paths

Sanitization must be performed prior to initial startup of your treatment center.

For sanitizing, the water-carrying lines are filled with the undiluted disinfectant for the water paths in order to reduce the bacterial load in the water paths.

If the service engineer skipped the sanitization procedure after installing your treatment center based on an agreement with you or sanitization has not been performed for more than one week, please perform the sanitization yourself. Refer to "Interactively guided sanitization of the treatment center" [→ 264] for more information.

Sanitization takes at least 24 hours.

##### Care and disinfection

Care, disinfect and sterilize the treatment center in accordance with the instructions in the section "Care, cleaning and maintenance by the practice team" [→ 202] prior to initial startup and after longer periods of disuse.

#### 4.1.2 Switching the treatment center on/off

The treatment center is equipped with a standby system for enhanced convenience when switching it on and off at the dentist element.

The treatment center therefore has a power switch at the base of the chair and a standby switch at the dentist element.

##### 4.1.2.1 Power switch

The power switch connects the treatment center to the power supply. During longer periods of disuse, the treatment center should be disconnected from the power supply. It then no longer consumes any energy.

The power switch contains an automatic device fuse.

##### Connecting the treatment center to the power supply

- ✓ The treatment center is installed by authorized technical personnel according to the "Installation instructions".
- Turn on the power switch **A**.
- ⚡ The treatment center is connected to the power supply.

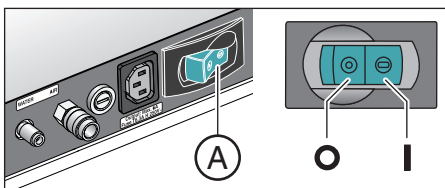

### Disconnecting the treatment center from the power supply

- ✓ The treatment center is powered down, see "Standby switch" [→ 50].
- > Turn off the power switch **A**.
- ↩ The treatment center is disconnected from the power supply.

#### 4.1.2.2 Standby switch

### Switching the treatment center on

The standby switch switches the treatment center from standby mode to operational readiness.

After switching it on, the operating system is booted and an automatic self-test is performed.

- ✓ The power switch is turned on.
- > Press the standby switch on the dentist element.
- ↩ The LED of the standby switch lights up on the dentist element.
- ↩ The treatment center powers up and establishes operational readiness.



If the next maintenance call is due in less than 42 days or the maintenance deadline has already been exceeded, a message appears on the touchscreen. For more information, please refer to "Inspection and maintenance" [→ 280].

### Switching the treatment center to the standby mode

At the end of the working day, the treatment center should be switched off via the standby switch on the dentist element to reduce energy consumption and for safety reasons. Air and water supply and all electronic components are switched by activating the standby switch. Only the standby circuit is still supplied with current. If no other devices are operating using the external device connection and the treatment center is not equipped with an internal PC, the power consumption in Standby mode is approximately 3 W.

- > Press the standby switch on the dentist element until a signal tone is heard. Then release the key.
- ↩ The treatment center will power down and switch into Standby mode.
- ↩ The LED of the standby switch on the dentist element goes out.



### 4.1.3 Selecting a user profile

The treatment center allows up to six user profiles to be managed. This allows multiple users to operate the treatment center without losing the individual settings for treatment and operation.

The following is stored in the user profiles:

- Programming of chair programs, see "Programming chair programs and shock positioning" [→ 75]
- Configurations in the Setup programs, see "Configuration of the treatment center (Setup)" [→ 191]
- Settings in the Instrument programs, see "Saving the instrument settings" [→ 88]
- Configuration of the Sivation dialog for PC control. The configuration is saved in the PC application Siucom Plus installed on the PC.

When the user profile is selected, the preset configurations and settings become available.

If any of the user profiles are not required, their number can be limited, see "Preselect the number of user profiles." [→ 194]

The user profiles **A** are distinguished with the letters A to F. The active user profile, in this case B, is displayed in the status bar on the touchscreen. If only one user profile is preselected, no display is shown. The user profile used last is automatically loaded when the treatment center is switched on.

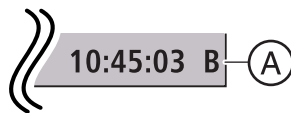

- ✓ The Start dialog is displayed on the touchscreen in the *Standard Start dialog* (shown) or *EasyMode Start dialog* operating mode. See "Start dialog operating modes" [→ 53].



- > Select the desired user profile. Touch the *User profile* key as often as necessary.
  - ↳ The user profile that is displayed in the status bar is active.

**Tip:** The individual user settings can be read out by the service engineer and transferred to other Sinus treatment centers. In this case, the user profiles only have to be set once.

## 4.2 Control concept of touchscreen

### 4.2.1 Virtual function keys

The touchscreen displays virtual function keys according to the program selected. Required functions can be activated either by touching the function keys with your finger or via the cursor with the foot switch.

#### Missing function keys

The adjacent illustration shows the touchscreen of a treatment center as supplied to the customer and maximally equipped.



Function keys for functions which the treatment center does not include are not displayed on the touchscreen. Moreover, the touchscreen user interface may vary due to individual setup settings, see "Configuration of the treatment center (Setup)" [→ 191].

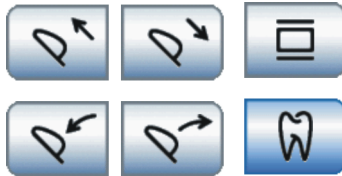

In the *Start dialog* this includes function keys for the following **equipment options**:

- Motor-driven headrest \*
- X-ray viewer
- Endodontic treatment \*

The keys marked with an asterisk (\*) are not displayed in the *EasyMode Start dialog*. However, the equipment options may be available, see "Start dialog operating modes" [→ 53].



Furthermore, the screens may vary due to individual **setup settings**. The following configurations may influence the *Start dialog*, see:

- "Preselecting the number of user profiles" [→ 194]
- "Setting the X-ray viewer key to white screen on Sivation monitor" [→ 196]

#### Key background color



General functions are represented by gray keys. If the corresponding function is switched on or active, the key is displayed in orange.



Keys that initiate a dialog change or lead to sub-screens and settings dialogs are displayed blue.

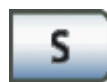

As long as a key remains activated, its active state is marked by a bold black border.

## 4.2.2 Start program operating modes

After the treatment center is switched on, the *Start dialog* automatically appears.

The start dialog can run in two operating modes. In the *Standard Start dialog* operating mode, the functions of the patient chair and instruments are each shown on separate screens. In the *EasyMode Start dialog* operating mode, the patient chair and instrument functions that are most important for the treatment are shown together on the same screen.

You can set the operating mode that you want to work with in the treatment center setup, see "Select Start dialog operating mode" [→ 194]. The operating modes are described in detail below:

### Standard Start dialog

In the *Standard Start dialog*, only the chair program function keys and, in the case of a motor-driven headrest, the *Move headrest in/out* function keys are displayed on the screen. The full range of functions of the treatment center can be used in this operating mode.

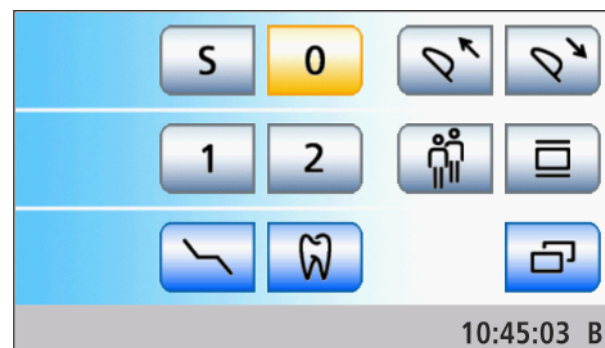

All other chair functions are listed separately on the *Manual Chair Adjustment* screen. This can be accessed via the *Manual Chair Adjustment* key.



Other general functions of the treatment center are listed in the *Start* sub-dialog. This can be accessed via the *Sub-dialog* key.



In the *Standard Start dialog* operating mode, the touchscreen will automatically display the instrument dialog of the removed instrument instead of the Start dialog. The toggles keys can be used to switch between the main programs *Start dialog* and *Instrument dialog*. All chair and instrument functions can be controlled via the touchscreen. The speed and intensity can be set using static quick setting keys (with the key values 0.09 or 0.2, 20, 40), the programmable quick setting keys (with changeable key values) or via the function levels (E1, E2). When the static quick setting keys are used, keys with three predefined motor speed values (0.09 or 2, 20, 40 x 1000 rpm) or intensity values (1%, 50%, 100 %) are displayed on the touchscreen.

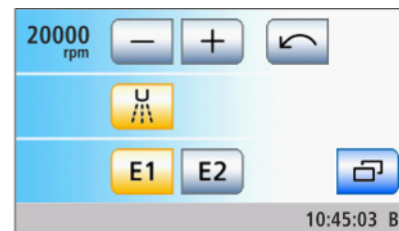

*Motor dialog with fixed quick setting keys (left), programmable quick setting keys (center) and function levels (right)*

### EasyMode Start dialog

The *EasyMode Start dialog* displays the function keys for the patient chair programs and manual chair adjustment, as well as the quick setting keys for adjusting the intensity of the instruments on the same screen. The most important function keys for the treatment are therefore always displayed on the touchscreen. There is no switching between the Start and Instrument dialog. The operation of the Sinus dental treatment center is thus similar to other Dentsply Sirona treatment centers that are operated without a touchscreen.

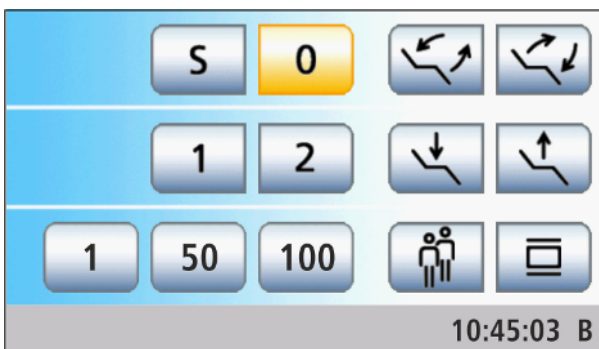

When an instrument is removed, the *EasyMode Start dialog* displays the chosen speed and intensity settings on the upper left of the touchscreen. The value can be set using the quick setting keys (1%, 50%, 100%). The quick setting keys with the values for intensity are also displayed on the motor dialog and on the ultrasonic dialog when the endodontics function is activated. The relevant information is displayed during the activation of a preselected coolant and for an activated counterclockwise rotation.

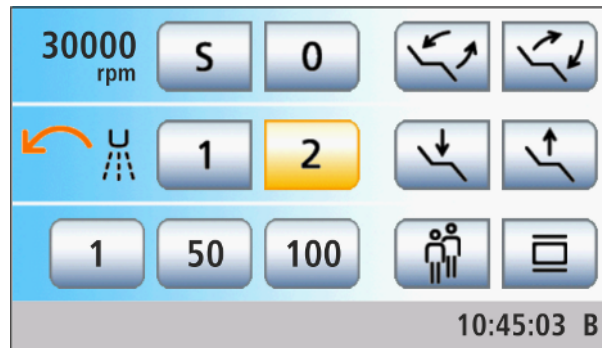

In the *EasyMode Start dialog* operating mode, the *Chair* and *Instrument* program change keys can be used to display the relevant sub-dialog. Other general functions of the treatment center are listed in the *Start* sub-dialog; other instrument functions are listed in the sub-dialog of the removed instrument.



The functional scope of the treatment center in the *EasyMode Start dialog* operating mode has the following limitations:

- The motor-driven headrest can only be operated via the 4-way switch
- The speed and intensity values of the instruments can be set only using the quick setting keys (1%, 50%, 100%); programmable quick setting keys and the function levels are not available
- the switch coolant on/off function, clockwise/counterclockwise rotation function and the boost function for the ultrasonic handpiece must be operated via foot control
- The instrument settings can only be saved with the SaveMode; the *Memory* key is shown in the sub-dialog of the instrument taken
- the hands-free touchscreen and fixed key operation via the 4-way foot control plate of the foot control (cursor control) is not available
- the ApexLocator can only be used for manual measurements using the file clamp in the *Start* sub-dialog
- The treatment functions for implantology and endodontic treatments are not available.

The *EasyMode Start dialog* is intended for users who would like to retain the familiar operating concept of other Dentsply Sirona treatment centers and who can do without the functions listed above.

### Program change keys



The LED of the relevant program change key lights up in the *Standard Start dialog* according to the program selected.

In the *EasyMode Start dialog*, the LED lights up in the *Start* sub-dialog, in the sub-dialog of the removed instrument and in the *Sivision* dialog.

It is not possible:

- to switch to the *Instrument* dialog or the sub-dialog of an instrument when no instrument has been removed
- to switch to the *Sivision* dialog when the PC connection has not been configured

You can change from sub-screens and settings screens to a main dialog by touching one of the three program change keys in the *Standard Start dialog*.

### 4.2.3 Sub-screens and settings screens

#### Sub-screens



Some programs are divided into a main dialog and sub-screens.

The function keys for the basic functions are displayed in the main programs. The *Sub-dialog* key (two rectangles) leads to further setting possibilities.



Sub-screens usually are automatically hidden after a certain period has elapsed. The *Return* key (return arrow) closes the opened sub-dialog immediately.

#### Settings screens

In many cases, functions not only can be switched on or off, but also can be set. If a function key is pressed and held (> 2 s), the corresponding settings screen appears. This screen superimposes the current screen. The screen located in the background has a semitransparent appearance and is temporarily disabled for inputs.

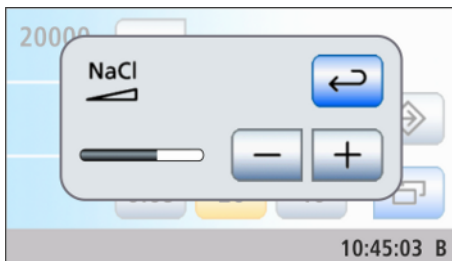

Settings screens usually are automatically hidden after a certain period has elapsed. The *Return* key (return arrow) closes the opened settings screen immediately.



#### 4.2.4 Status bar

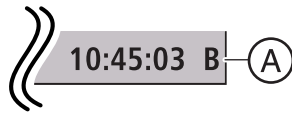

The status bar is located at the bottom edge of the screen. If multiple user profiles **A** are preselected, the active user profile A to F is displayed along with the current time, including a display with seconds.



In addition, status messages are displayed to indicate, for example, change the amalgam separator, add water sanitizing agent, charge the battery of the wireless foot control, error messages, refill the cleaning agent for chemical treatment of the suction hoses, or number of days left until the next maintenance call or sanitization run.

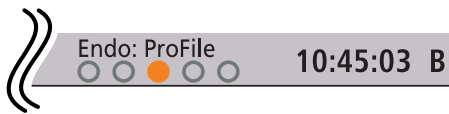

If the treatment function is switched on, the selected treatment and the assigned bur drive are also displayed here.

## 4.3 Foot control

The treatment center can be operated using a wireless foot control or a foot control with a cable connection.

### 4.3.1 Wireless foot control

Technical data of the wireless module, see "Foot control radio interface" [→ 24].

#### 4.3.1.1 Setting the wireless foot control on the treatment center

The wireless foot control must be assigned to the treatment center via by registering it. This prevents malfunctions caused by neighboring wireless foot controls.

- ✓ The treatment center and wireless foot switch are ready for operation.
- ✓ All instruments are in their holders.

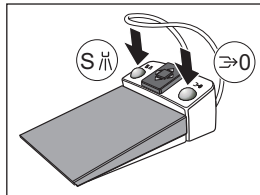

1. Simultaneously press and hold the left and right buttons of the foot control (> 2 s).
  - ✚ A beep sounds. The following message appears on the touch screen:
  - ✚ The dialog box closes automatically after a certain period of time if no key is activated. The wireless foot control will not be registered.
2. Confirm that this wireless foot control is to be used on the treatment center by pressing the *OK* key. The registration process can be interrupted with the *Esc* key.
  - ✚ The message is hidden. The wireless foot control is assigned to the treatment center.

#### 4.3.1.2 Battery voltage message



The wireless foot control is powered by a battery. An almost empty battery is detected by the system and displayed in the status bar. In this case, the battery should be replaced within a week.

When the battery is completely empty, an error code is output, see "Error messages" [→ 282]. The symbol of the wireless foot control is now displayed flashing. Replace the battery as soon as possible to prevent system failure.

The battery can be changed by the user, see "Changing the battery of the wireless foot control" [→ 277].

### 4.3.2 Operating the foot control

The foot control operating elements are assigned different functions, depending on whether the instruments are all deposited or an instrument is removed from its holder.

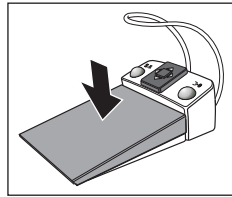

### Foot pedal

- ✓ An instrument is **removed**.
- Press the foot pedal.
  - ↳ The instrument is activated. The intensity is regulated according to the pedal movement if necessary (if the foot control switch is set, see "General instrument functions" [→ 92]). If the intraoral camera is removed, the camera image will be focused if necessary and switched to still or live image.

### 4-way control plate

If the cursor control is **switched on**, it is operated via the 4-way control plate, see "Using the cursor control" [→ 60].

If the cursor control is **switched off**, then:

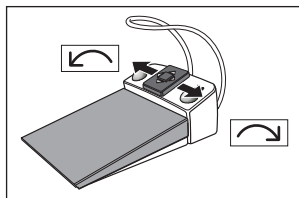

- ✓ An electric motor is **removed** from the holder.
- Slide the 4-way control plate to the right or left.
  - ↳ The clockwise/counterclockwise rotation of the electric motor is activated.

### IMPORTANT

#### Allocation of functions during active treatment

The allocation of functions may differ when the Treatment function is active.

- Note the position of the orange and blue cursor, see "Using the cursor control" [→ 60].

### Left button

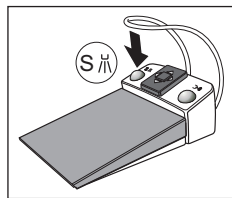

- ✓ All instruments are **in their holders**.
- Press the left button.
  - ↳ The chair moves to mouth rinsing position S.
- ✓ An instrument (motor, turbine, SiroSonic TL) is **removed from the holder**.
- Press the left button.
  - ↳ Cooling (spray, air, or NaCl) is switched on/off. If the intraoral camera is removed, the video still image is saved in Sidexis; the live image is displayed in the next quadrant in SI Video.

### Right button

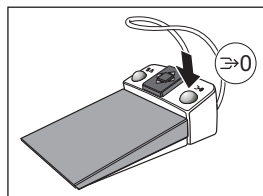

- ✓ All instruments are **in their holders**.
- Press the right button.
  - ↳ The chair moves to entry/exit position 0.
- ✓ An instrument (motor, turbine) is **removed from the holder**.
- Press the right button.
  - ↳ The chip blower remains switched on as long as the button is pressed. The boost function can be selected in ultrasound mode. When the intraoral camera is removed, it is possible to toggle between single image and quad image in SI Video.

### 4.3.3 Using the cursor control

The cursor control cannot be used in the *EasyMode start dialog* operating mode.

#### 4.3.3.1 Functionality

##### Cursor control as an alternative mode of operation

The touchscreen and the fixed keys of the dentist element can also be operated hands-free via the foot control. This method of operation optimally supports hygiene, especially in connection with sterile treatment.

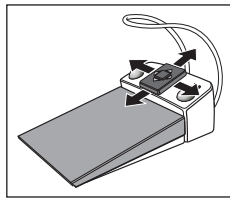

For cursor control, the foot control features a 4-way foot control plate that can be moved in four directions.

The cursor position is optically displayed on the touchscreen or on the fixed keys.

The cursor control is reserved for the Start and Instrument programs. The Sivation programs cannot be controlled via the cursor.

##### Cursor control setting options

Note that different settings can be made for the cursor control in the Setup dialog. The functions assigned to the 4-way foot control plate vary according to its setting. The adjacent symbols for setting the cursor are used in the Setup dialog.

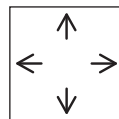

- Cursor control switched off:  
Counterclockwise or clockwise instrument motor rotation can be selected by sliding the 4-way foot control plate to the left or right.

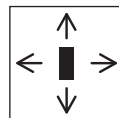

- Cursor control switched on, without dialog change:  
The cursor can be moved along the cursor path by holding or repeating upward or downward actuation of the 4-way foot control plate.

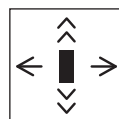

- Cursor control switched on, with dialog change:  
The cursor can be moved along the cursor path by holding or repeating upward or downward actuation of the 4-way foot control plate. If the cursor is located at the end of the cursor path, it can be toggled between the Start dialog and the Instrument dialog.

Please also note the information on "orange and blue bars," see below.

To set the cursor control to the mode you prefer, refer to "Setting the cursor control" [→ 194].

##### Current cursor position



If the cursor control is activated, the current position of the cursor is displayed by an orange bar located between the pairs of keys on the touchscreen or between the fixed keys on the EasyTouch control panel.

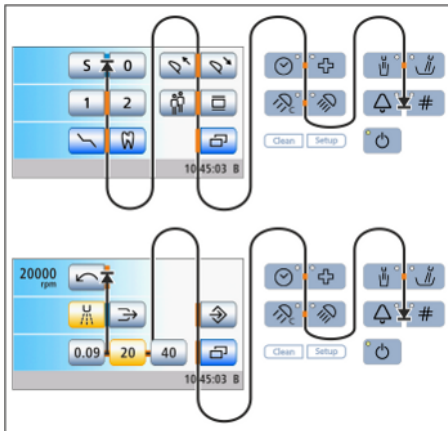

### Cursor path

The cursor path runs between the pairs of keys, moving from top to bottom and from left to right, usually in multiple loops. The cursor path can be traversed between the starting and end points either in a forward or a reverse direction.

If no further cursor position is available on the touchscreen, the cursor jumps out of the touchscreen. The cursor path is then continued between the fixed keys on the EasyTouch control panel.

In instrument screens, all quick setting keys are selected simultaneously. This is indicated by a horizontal orange bar located behind the quick setting keys. The speed or intensity is then set by actuating the 4-way foot control plate to the left or right briefly (values on quick setting keys) or for a longer time (intermediate values), see "Operating the cursor control" [→ 61].

The *Clean* key, *Setup* routine and standby switch cannot be accessed via the cursor control.

This adjacent image shows an example of the control panel of the Sinius and Sinius TS dentist element. The cursor path of the Sinius CS dentist element also follows this principle.

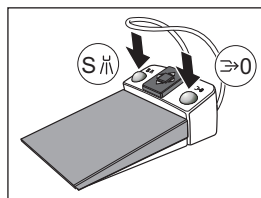

### Orange and blue bars

A blue bar indicates which functions are assigned to the left or right button of the foot switch. For example, in the start dialog, the chair program "rinsing position" (S) and entry/exit position (0) are assigned to the buttons, but in the instrument dialog spray or chip blower.

If the cursor control **without** scree change is activated, the blue bars also can be selected with the cursor. If the cursor control **with** dialog change is activated, the blue bars are skipped for faster navigation.

### Cursor return

Once a function is activated with the cursor control, the orange cursor typically returns to the starting position of the dialog, for instance after switching on the X-ray viewer, the operating light, or cuspidor flushing. The cursor position does not change for functions that are operated by permanent shifting of the 4-way foot control plate, e.g., manual chair adjustment.

### Chip blower key in the Instrument dialog



When the cursor control is activated, the motor and turbine dialog will display the *Chip blower* key.

#### 4.3.3.2

### Operating the cursor control

#### Moving the cursor

- > Briefly slide the 4-way foot control plate upward or downward.
  - ↳ The orange cursor moves forward or back one cursor position.

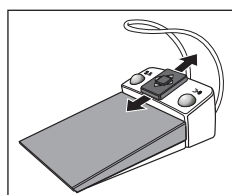

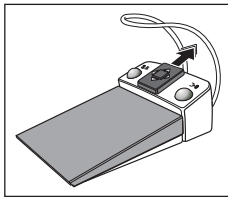

- Slide and hold the 4-way foot control plate up or down (auto cursor).
  - ↪ The orange cursor slowly moves from one cursor position to the next.

### Activating a function or fixed key

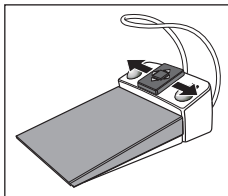

- Activate the left key: Slide the 4-way foot control plate to the left. Activate the right key: Slide the 4-way foot control plate to the right.
  - ↪ The selected key is highlighted orange on the touchscreen (if switched on) or is displayed in gray or blue (if switched off). The LED of the selected fixed key lights up or goes out on the control panel of the dentist element.
  - ↪ The orange cursor usually returns to the starting position of the dialog after activation.

### Activating a quick setting key and setting intermediate values

Operation of the cursor control for screens with quick setting keys is illustrated based on the example of the Motor dialog.

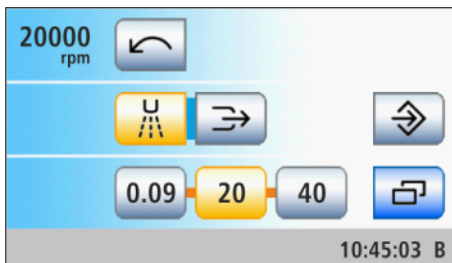

- ✓ The cursor control is switched on.
- 1. Move the cursor to the quick setting keys.
  - ↪ The quick setting keys are highlighted with an orange bar.

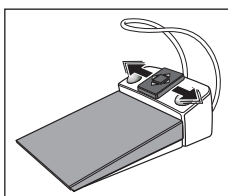

- 2. Setting the values of the quick setting keys: Move the 4-way foot control plate briefly to the left or right. Setting intermediate values: Move the 4-way foot control plate to the left or right and hold this position.
  - ↪ The motor speed is displayed in the first line. If the motor is set to a value corresponding to one of the quick setting keys, it is highlighted orange.

### Changing programs

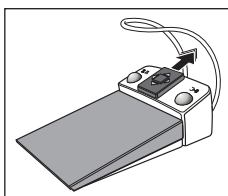

- ✓ Cursor control with dialog change is switched on.
- ✓ An instrument is removed from its holder.
- 1. Position the cursor at the starting point of the cursor path.
- 2. Move the cursor past the start position. Hold the 4-way foot control plate in the upward position.
  - ↪ The touchscreen display changes to the Start or Instrument dialog.

## 4.4 Patient chair

### 4.4.1 Safety instructions

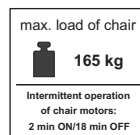
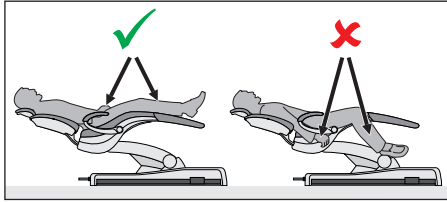

#### **⚠ CAUTION**

The free space under the patient couch and up to the water unit can be decreased due to chair movements.

Parts of the patient's or user's body may be pinched or crushed.

- Do not allow any limbs to stick out in the space between the chair upholstery, armrests and chair base. Please make sure that the patient's arms and legs rest on the upholstery of the chair.
- Do not place any objects on the base of the chair.

#### **⚠ CAUTION**

The maximum load capacity of the patient chair is 165 kg (363.8 lbs) defined in ISO 6875 (tested with multiple safety according to IEC 60601-1).

If the maximum load capacity is exceeded, there is a risk of damage to the treatment chair and injury to the patient.

- Never allow any persons who weigh more than 160 kg (352.7 lbs) to sit on the patient chair. The maximum permitted load capacity is indicated on a label next to the rating plate of the treatment center.
- The maximum additional weight of accessories mounted on the patient chair is 5 kg (11 lbs).

#### **⚠ CAUTION**

Objects may protrude into the movement range of the chair.

There is a risk of crushing the patient and damaging the objects.

- Make sure that no objects such as e.g. windows, drawers or other devices protrude into the movement range of the treatment chair.

#### **IMPORTANT**

##### **Chair interlock**

As long as a treatment instrument is activated, all functions for moving the patient chair are disabled for safety reasons.



If chair movement is permanently blocked, please contact your service technician.

### 4.4.2 Safety stop

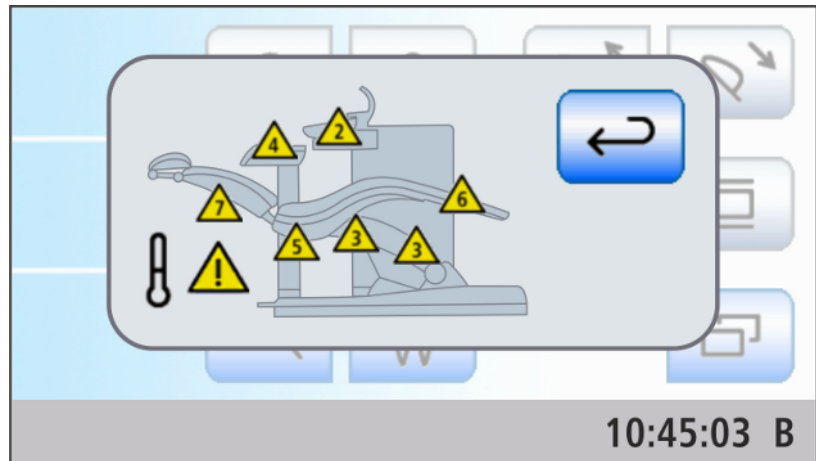
The treatment center is equipped with various safety stops to prevent crushing and damage. The cutoff trigger points are shown in the following illustration:



*Display of triggered safety switches (all shown on one illustration)*

2	Cuspidor bowl
3	Lift frame
4	Assistant element support arm
5	Rear facing, right/left
6	Footrest
7	Backrest
 	Motor for height adjustment or backrest of the chair overheats

The following occurs when one or more safety switches are triggered:

- All safety switches cause an acoustic signal is played twice each time a movement stops or starts. Exception cuspidor: only when movement starts
- All chair movements stop immediately
- The triggered safety switches are displayed on the touchscreen
- when the patient chair moves (this does not apply to the assistant element or swiveling cuspidor), a corrective movement is carried out in the opposite direction for approx. 2 seconds. Except the lift frame – the corrective movement is always upward

As long as a safety switch is activated, further operation of the treatment center is limited!

If a safety switch is permanently blocked, please contact your service technician.



### 4.4.3 Triggering an immediate movement stop

You can stop the movement of the chair to a programmed position as follows:

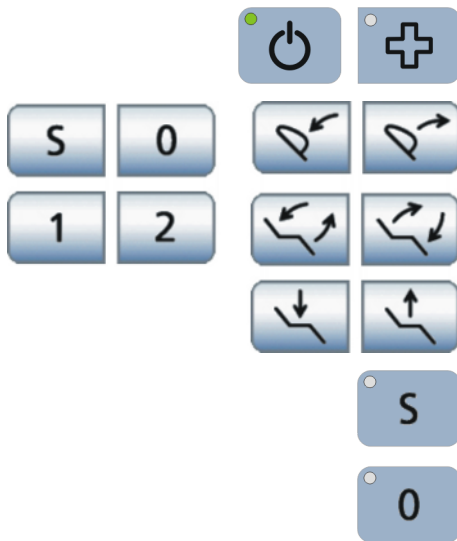

- > Press the standby switch or the *Shock positioning* fixed key on the dentist element.
- > Press a key relating to the patient chair on the touchscreen or a key to tilt the motor-driven headrest.

- > Press one of the patient chair keys on the control panel of the assistant element.

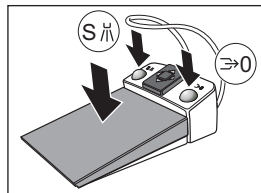

- > When all instruments are in place, press the pedal or the left or right button of the foot control.
- > With an instrument removed, press the pedal of the foot control.

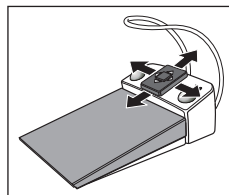

- > With the cursor control switched off, actuate the 4-way control plate on the foot control in any direction.
- > With the cursor control switched on, move the cursor to any of the keys relating to the patient chair.

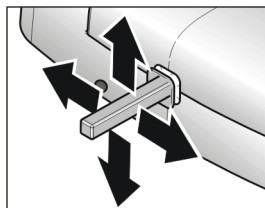

- > Move the 4-way foot switch in any direction.

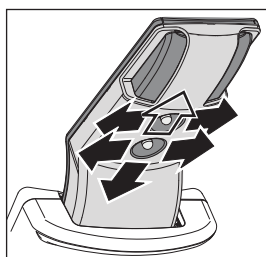

- > Activate one of the 4-way switches on the motorized headrest in any direction. Exception: The upper 4-way switch up/down, see note below.

- ⚡ All movements of the treatment center are stopped immediately.

#### IMPORTANT

The function keys and switches for adjusting the headrest to the height of the patient can be used during the program run. This does not trigger a movement stop.

#### 4.4.4 Armrests

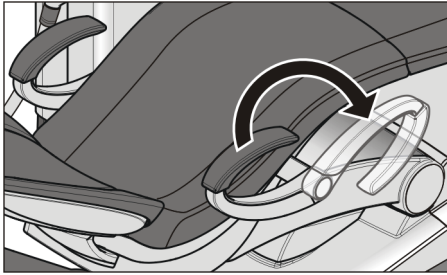

Armrests are available for the patient chair.

The right armrest can be swiveled forward to make it easier for patients to get in and out of the chair.

#### CAUTION

Always swivel the armrest completely to one of the stops. Do not leave the armrest in a middle position to prevent injuries.

#### 4.4.5 Vario footrest

The footrest can be folded forward by approximately 10 cm to adjust it to the patient's height.

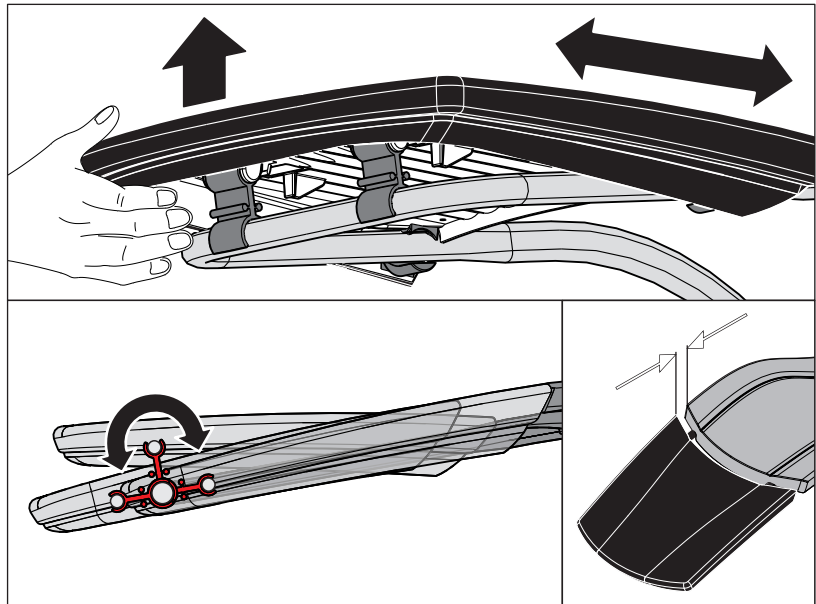

- > Lift the foot end and pivot the footrest forward or backwards.

#### CAUTION

Make sure while adjusting that the footrest is locked securely in place of the corresponding end position.

Make sure to avoid trapping fingers while adjusting.

If the patient chair features lounge upholstery, there is no footrest. The entire reclining surface is upholstered.

#### 4.4.6 Adjusting the motor-driven headrest

The motorized headrest can be adjusted via the touchscreen or directly on the headrest.

##### CAUTION

**Fine objects can enter the mechanism of the motorized headrest through the gap.**

- Long hair, dangling jewelry or loosely fitting clothing can be pulled in.
- > Position the patient so that hair or other objects cannot be pulled in while the head rest is in motion.

##### WARNING

**A strong magnet is integrated into the bottom of the head pad.**

The magnet could affect any active implant located nearby. Furthermore, direct contact of the head pad with magnetic cards can delete data stored on the cards.

- > Therefore, make sure that the magnet is never located in the immediate vicinity of any patients, users or technical personnel with an active implant. If necessary remove the head pad from the headrest.
- > Make sure that no magnetic cards or any other data storage media are located in the immediate vicinity of the head pad.

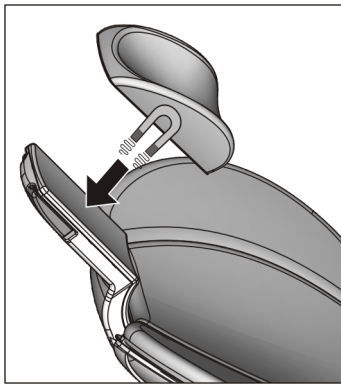

##### 4.4.6.1 Moving the headrest in/out

The treatment chair is adjusted to the patient's stature by moving the headrest in or out.

###### Via touchscreen



- ✓ The *Standard Start dialog* or the *Manual Chair Adjustment* program is displayed on the touchscreen.
- > Touch the *Headrest in/out* keys.

###### Via the 4-way switch

- > Slide the upper 4-way switch upward or downward.

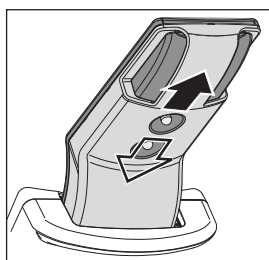

##### 4.4.6.2 Inclining the headrest

The headrest can be tilted either via motor drive or manually (quick mechanical adjustment).

###### Via touchscreen



- ✓ The *Standard Start dialog* or the *Manual Chair Adjustment* program is displayed on the touchscreen.
- > Touch the *Tilt headrest* keys.

#### Via the 4-way switch

- > Slide the upper 4-way switch to the left or right.

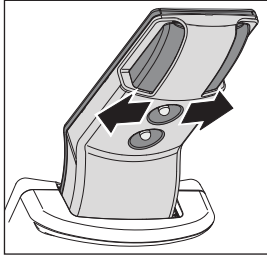

#### Via quick mechanical adjustment

1. Hold the headrest securely in place before unlocking it.
2. Press buttons **A** together.
  - ↳ The headrest is thus disconnected from the motor drive and can be tilted manually.

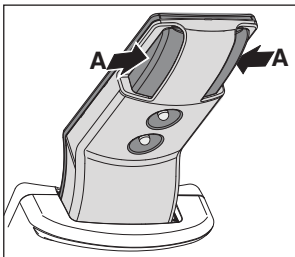

#### Via the 4-way foot control

It can be set so that the tilt of the headrest can be adjusted using the 4-way foot control at the base of the chair; see "Linking headrest tilt to the 4-way foot control" [→ 196].

- > Actuate the 4-way foot switch to the left or right.

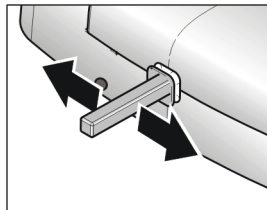

#### 4.4.7 Adjusting the double articulating headrest

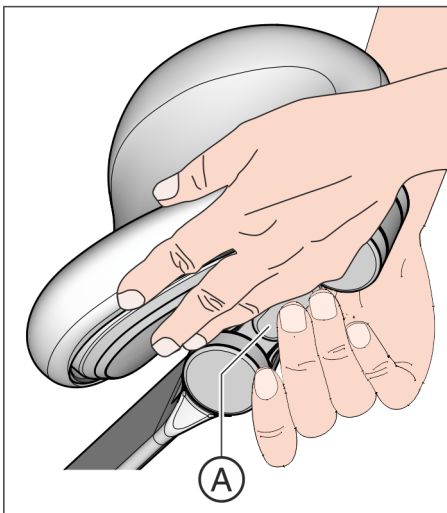
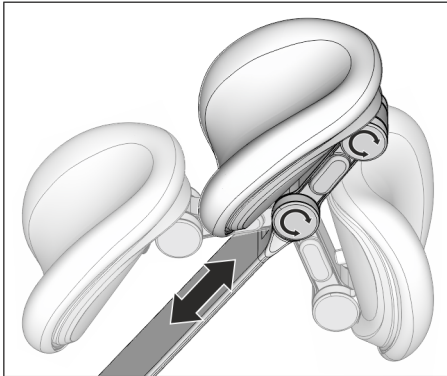

The double articulating headrest is equipped with two rotary joints. They facilitate manual adjustment of head inclination for maxillary/mandibular treatments. The headrest extension can be pushed in or pulled out manually to adjust it to the height of the patient.

#### **⚠ CAUTION**

**When the lock on the double articulating headrest is released, the both rotary joints lose their holding power.**

If the headrest is not supported when the lock is released, the patient's head might suddenly fall backward.

- Always support the headrest and thus the patient's head prior to releasing the locking mechanism on the double articulating headrest!
- Place your hands so your fingers will not be pinched.
- Tell the patient that you are going to adjust the headrest.
- Before releasing the headrest, always ensure that both joints are securely locked.

1. Place one hand under the headrest to support the patient's head.
2. Use the other hand to press the release button **A**.
  - ↪ Both rotary joints are now freely movable.
3. Adjust the headrest to the desired treatment position. Then let go of the release button **A**.
  - ↪ Both rotary joints lock into place. Ensure that the joints are securely positioned! The headrest is secure again.

### 4.4.8 Moving the patient chair via chair programs

The chair programs can be selected via the touchscreen. The entry/exit and mouth rinsing positions can also be selected via the assistant element fixed keys and the foot control.

You can individually re-program the factory preset chair programs to suit your own requirements, see "Creating chair programs and shock positioning" [→ 75].

#### WARNING

**The Sinius CS and Sinius TS dentist elements could be positioned within the movement range of the patient chair.**

During an automatic program run, such as moving toward the entry/exit or mouth rinsing positions, the patient may collide with the Sinius CS and Sinius TS dentist elements or the support arms. The patient is at risk of being crushed.

- Before moving the patient chair, position the Sinius CS and Sinius TS dentist elements so that collision with the patient or the patient chair is impossible.

#### IMPORTANT

**Chair movements with cuspidor swiveled in**

With the cuspidor bowl swiveled in, the chair cannot be moved. This prevents the patient from colliding with the cuspidor. Swing the cuspidor outward before initiating chair movement.

#### 4.4.8.1 Moving the patient chair to the entry/exit position

The following functions are triggered for simple patient entry and exit in the entry/exit position:

- The patient chair moves to an upright position
- The operating light switches off

The tumbler heater can be set so that it automatically switches off when the entry/exit position (0) chair program is activated; see "Linking the tumbler heater to the entry/exit position" [→ 198].

#### WARNING

**The patient's feet may get caught in the instrument hoses of the Sinius dentist element when he enters or leaves the patient chair.**

The patient may trip or fall.

- Turn the Sinius dentist element outward before the patient enters or leaves it.

#### Via touchscreen



- ✓ The *Start dialog* is displayed on the touchscreen.
- Touch the 0 key briefly (< 2 s).

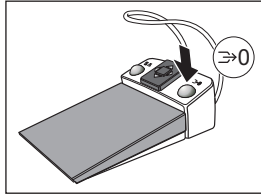

#### Via foot control

- ✓ All instruments are in their holders.
- > Press the right button of the foot switch.

#### Via the assistant element



- > Press the 0 key on the assistant element briefly (< 2 s).

### 4.4.8.2 Moving the patient chair to the mouth rinsing position

The following functions are triggered in the mouth rinsing position:

- The operating light switches off
- The chair moves the patient to an upright position

#### Via touchscreen



- ✓ The *Start dialog* is displayed on the touchscreen.
- > Touch the S key briefly (< 2 s).

#### Via foot control

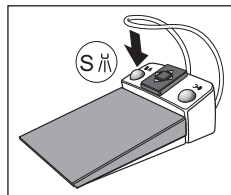

- ✓ All instruments are in place.
- > Press the left button of the foot control.

#### Via the assistant element

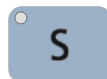

- > Press the S key on the assistant element briefly (< 2 s).

### 4.4.8.3 Using the last position memory function

The last chair position is stored before the patient chair moves to mouth rinsing position S. When mouth rinsing position key S is pressed again, the treatment center returns to the previously set treatment position.

- ✓ The patient chair can be in any treatment position.
- 1. Press the S key on the touchscreen, or press the S key on the user interface of the assistant element, or press the left button of the foot control (with all instruments in place in their holders).
  - ↳ The treatment center moves to the mouth rinsing position.
- 2. Press the button S again.
  - ↳ The treatment center automatically returns to the position where the patient chair was located prior to the mouth rinsing position.

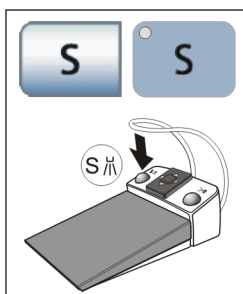

#### 4.4.8.4 Activating other chair programs



- ✓ The *Start dialog* is displayed on the touchscreen.
- > Touch the *1* key or the *2* key briefly (< 2 s).



### 4.4.9 Moving the chair manually

#### ⚠ WARNING

The Sinius CS and Sinius TS dentist elements could be positioned within the movement range of the patient chair.

Moving the patient chair may cause the patient to collide with the Sinius CS and Sinius TS dentist elements or the support arms. The patient is at risk of being crushed.

- Before moving the patient chair, position the Sinius CS and Sinius TS dentist elements so that collision with the patient or the patient chair is impossible.

#### IMPORTANT

##### Chair movements with cuspidor swiveled in

With the cuspidor bowl swiveled in, the chair cannot be moved. This prevents the patient from colliding with the cuspidor. Swing the cuspidor outward before initiating chair movement.

#### 4.4.9.1

##### Open manual chair setting screen

The *Manual Chair Adjustment* program can only be accessed in the *Standard Start dialog* operating mode. In the *EasyMode Start dialog*, the manual chair adjustment keys are displayed permanently, see adjacent illustration.

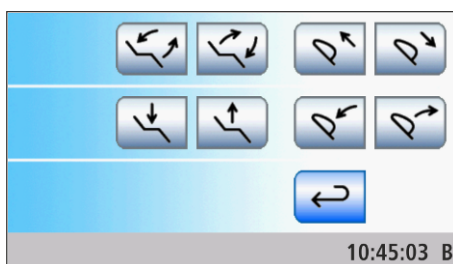
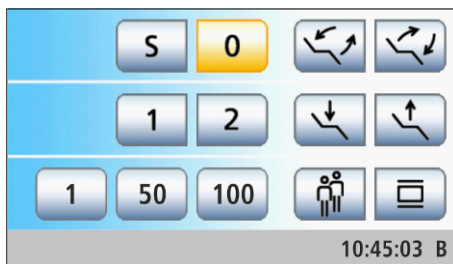

- ✓ The *Standard Start dialog* is displayed on the touchscreen.

1. Touch the *Manual Chair Adjustment* key.

↳ The *Manual Chair Adjustment* screen is displayed.

2. Perform the settings described in the following sections.

#### 4.4.9.2

##### Tilting the patient couch

Moves the seat and backrest without any compression or stretching effects for the patient

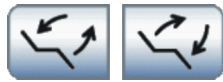

#### Via touchscreen

- ✓ The *EasyMode start dialog* or *Manual Chair Adjustment* program is displayed on the touchscreen.
- > Touch the *Tilt patient couch* keys.

#### Via the 4-way switch

- > Move the lower 4-way switch to the left or right.



#### Via the 4-way foot switch

- ✓ In the *Setup dialog*, control of the *Tilt patient couch* function via the 4-way foot control cannot be replaced by the *Headrest tilt* function, see "Linking the headrest tilt to the 4-way foot control" [→ 196].
- ✓ The spray aspirator must be in place when the 4-way foot switch is assigned to the aspirator in the *Setup dialog*. See "Linking the spray aspirator to the 4-way foot switch" [→ 195].
- > Slide the 4-way foot switch to the left or right.

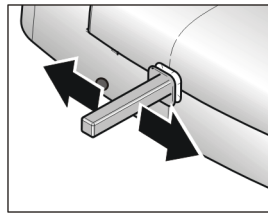

### 4.4.9.3 Adjusting the chair height

#### Via touchscreen

- ✓ The *Manual Chair Adjustment* program or the *EasyMode Start program* is displayed on the touchscreen.
- > Touch the *Chair Height Adjustment* keys.



#### Via the 4-way foot switch

- ✓ The 4-way foot switch is not assigned to the suction system of the assistant element via the *Setup program*.
- > Slide the 4-way foot switch upward or downward.

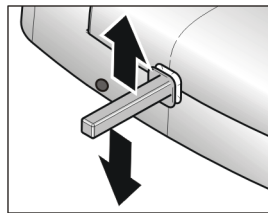

#### Via the 4-way switch

- > Slide the lower 4-way switch upward or downward.

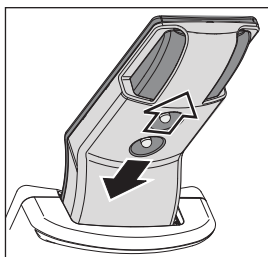

## 4.4.10 Creating chair and shock positioning programs

### Chair programs



The four chair programs preset in the factory:

- Mouth rinsing position S
- Entry/exit position 0
- 1 and 2

can be individually reprogrammed for each of the six user profiles (A to F).

✓ The *Start dialog* is displayed on the touchscreen.

1. Move the patient chair to the desired treatment position; see "Moving the chair manually" [→ 73].
2. For motor-driven headrest: Tilt the headrest to the desired treatment position; see "Inclining the headrest".
3. Switch the operating light on or off (this will be included in the program), see "Operating light" [→ 171].
4. Press and hold the desired program key (S, 0, 1, 2) (> 2 s).
  - ↳ An acoustic signal sounds. Your settings are now stored under the desired program key.

**Note:** Chair programs S and 0 can also be programmed on the assistant element side.

### Shock positioning

When the *Shock positioning* key is pressed, the patient chair immediately moves to a position suitable for shock positioning of the patient.

The shock positioning position preset at the factory can be reprogrammed.



1. Move the patient chair to the desired position.
2. Press and hold the *Shock positioning* key (> 2 s).

#### **WARNING**

**Program this key exclusively for shock positioning the patient, never use as a treatment position.**

### 4.4.11 Setting the active lumbar support

The patient chair has the option of lumbar support.

#### Opening Start sub-dialog

- ✓ The *Start dialog* is displayed on the touchscreen.
- > In the *Standard Start dialog*: Touch the *Sub-dialog* key.  
In the *EasyMode Start dialog*: Press the *Chair program change* key.



- ↪ The *Start* sub-dialog is displayed.

#### Setting the active lumbar support

- > Adapt the active lumbar support to the patient's spinal curvature.  
Touch the *Decrease/increase active lumbar support* keys.



The active lumbar support functions switch off automatically when the chair approaches the entry/exit position *O* or the mouth rinsing position *S*.

## 4.5 Dentist element

### 4.5.1 Maximum load capacity

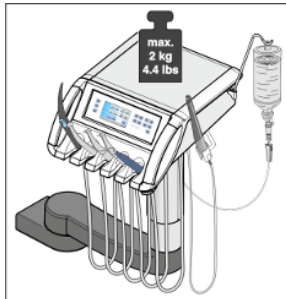

The maximum load of the Sinius (sliding track device) dentist element is 2 kg (4.4 lb). A sterilizable silicone mat can be placed over the dentist element.

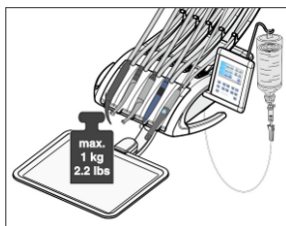

The maximum load on the Sinius CS dentist element tray is 1 kg (2.2 lb).

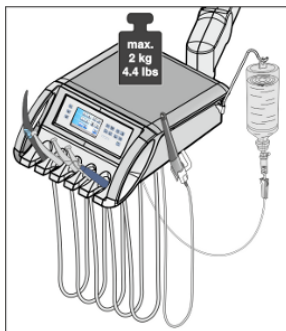

The maximum load of the Sinius TS dentist element with a tray holder is 2 kg (4.4 lb). A sterilizable silicone mat can be placed over the dentist element.

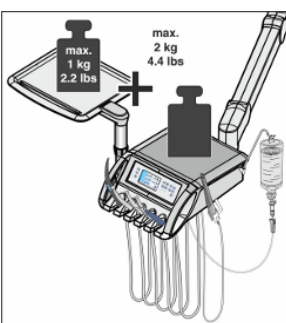

The total maximum load of the Sinius TS dentist element with a tray holder is 2 kg (4.4 lb). In this case the maximum load of the tray is 1 kg (2.2 lbs). A sterilizable silicone mat can be placed over the dentist element.

For each version, an NaCl bottle with the corresponding accessories (weighing approx. 1 kg or 2.2 lb) can also be attached to the dentist element. See "Preparing for use of NaCl saline solution" [→ 96].

### 4.5.2 Height adjustment

The height of the Sinius (sliding track device) dentist element can be adjusted to achieve an ergonomic instrument height.

Please contact your service engineer.

### 4.5.3 Positioning the dentist element

#### NOTE

**Sudden movements can cause instruments to fall out of the holder in the dentist element.**

- > Try to avoid sudden movements of the dentist element.

#### Sinius dentist element

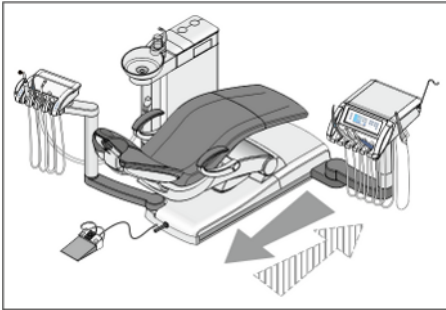

The sliding track version allows you to move the dentist element along the entire length of the patient chair. Combined with the rotary joints on the support arm, the dentist element can be perfectly positioned for any procedure.

1. Hold the dentist element by the two handles and move it along the chair base.
2. Move the support arm and the dentist element to the desired treatment position.

#### WARNING

**The patient's feet may get caught in the instrument hoses of the Sinius dentist element when he enters or leaves the patient chair.**

The patient may trip or fall.

- > Turn the Sinius dentist element outward before the patient enters or leaves it.

#### Sinius CS dentist element

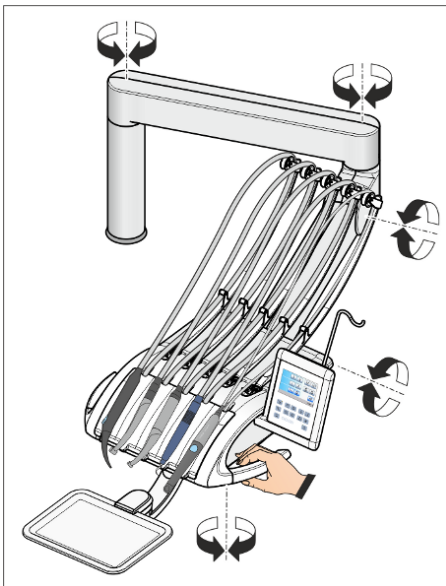

In the swivel arm version, the dentist element is attached to the water unit with a flexible support arm. The dentist element is held in place at the adjusted height with a pneumatic locking brake in the support arm. A capacitive sensor is integrated into both handles to release the brake. The sensor responds when the handles are touched.

1. Grip a handle with your hand.
  - ↳ The locking brake is released with the sound of pressurized air.
2. Move the dentist element to the required position and release the handle.
  - ↳ The dentist element is now positioned securely.

Please note that you must wait for at least two seconds before releasing the brake in the support arm again.

#### WARNING

**The Sinius CS dentist element could be positioned within the movement range of the patient chair.**

Moving the patient chair may cause the patient to collide with the Sinius CS dentist element or its support arm. The patient is at risk of being crushed.

- > Before moving the patient chair, position the Sinius CS dentist element so as to make collision with the patient or the patient chair impossible.

**⚠ CAUTION**

Folding the tray arm in the area of the middle hinge may cause crushing injuries.

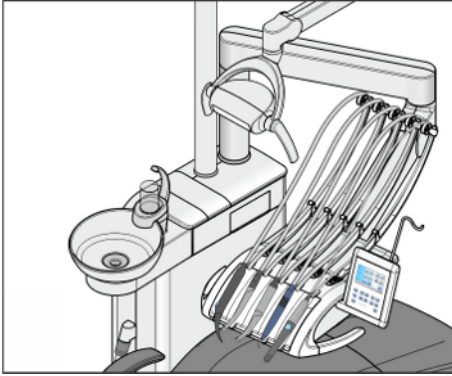

In the **standard position**, the Sinius CS dentist element is attached to the rear of the water unit.

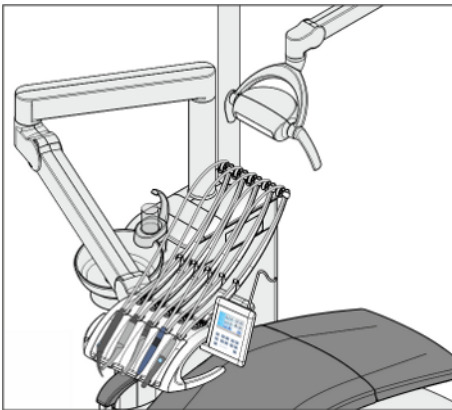

Alternatively, the Sinius CS dentist element can be attached to the front of the water unit (**special position**). This type of mounting minimizes the travel distance of the dentist element and makes it easier for the patient to get in and out of the chair.

The operating light is then mounted at the rear.

When the Sinius CS dentist element is mounted in the special position at the water unit, the treatment center cannot be equipped with an X-ray tube unit on the light post. For information about the Heliodent Plus model, please see the chapter "X-ray tube unit" [→ 173].

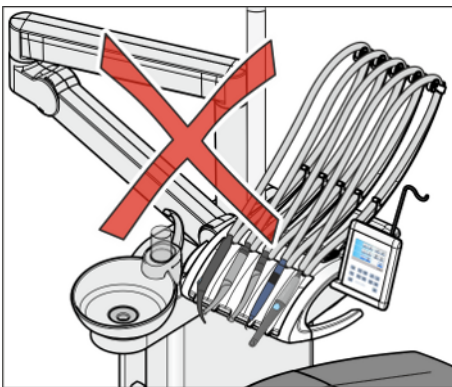

**NOTE**

In the special position, there is an increased danger of collision with the following components:

- Between the support arm and tumbler filler
- Between the support arm and tumbler
- Between the support arm and cuspidor
- Between the support arm and the instruments of the assistant element

Always move the dentist element carefully to avoid collision.

Do not position the support arm behind the tumbler filler.

**Sinius TS dentist element**

In the OTP version, the dentist element is attached to the water unit with a flexible support arm. The dentist element is held in place at the adjusted height with a pneumatic locking brake in the support arm. A capacitive sensor is integrated into both handles in the upper area to release the brake. The sensor responds when the handles are touched.

Touching the lower area of the handle does not release the locking brake. The dentist element can then only be positioned in a horizontal direction. The height of the dentist element is maintained.

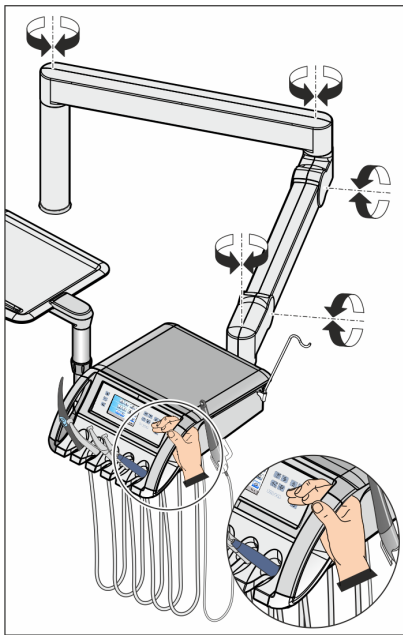

### Positioning the dentist element vertically and horizontally

1. Grip a handle in the upper area.
  - ↪ The locking brake is released with the sound of pressurized air. The dentist element can be raised and lowered, as well as moved horizontally.
2. Position the dentist element and release the handle again.
  - ↪ The dentist element is secured at the height set.

Please note that you must wait for at least two seconds before releasing the brake in the support arm again.

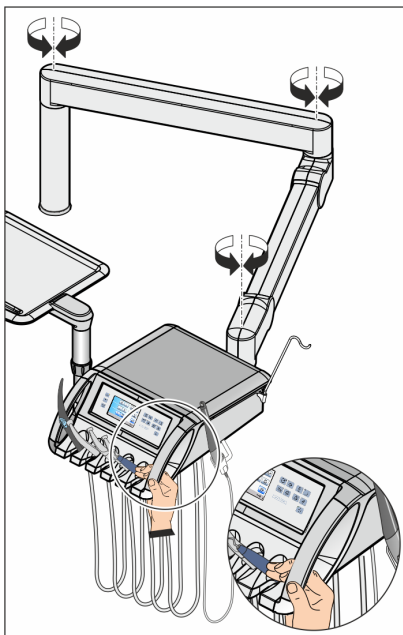

### Only move the dentist element horizontally

- Take hold of a handle in the lower area and move the dentist element in a horizontal direction.
  - ↪ The locking brake in the support arm remains locked. The height of the dentist element is maintained.

#### **⚠ WARNING**

**The Sinus TS dentist element could be positioned within the movement range of the patient chair.**

Moving the patient chair may cause the patient to collide with the Sinus TS dentist element or its support arm. The patient is at risk of being crushed.

- Before moving the patient chair, position the Sinus TS dentist element so as to make collision with the patient or the patient chair impossible.

#### **⚠ CAUTION**

Folding the tray arm in the area of the middle hinge may cause crushing injuries.



#### 4.5.4 Fixed keys on the dentist element

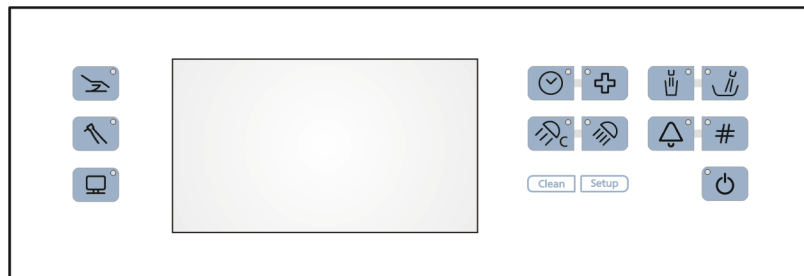

Arrangement of fixed keys on the Sinius and Sinius TS dentist elements

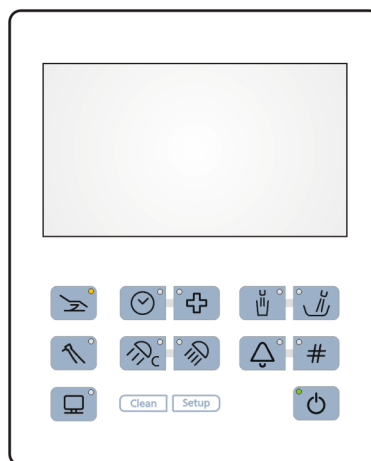

Arrangement of fixed keys on the Sinius CS dentist element

##### 4.5.4.1 Standby switch



The treatment center is switched on/off with the standby switch.  
 To switch off, press and hold the key until an acoustic signal sounds. Then release the key.

#### IMPORTANT

##### Power switch

The treatment center also features a power switch on the base of the chair that separates the treatment center from the power supply, see "Switching the treatment center on/off" [-> 49].

##### 4.5.4.2 Program change keys



The program change keys allow the user to switch between the main programs *Start dialog*, *Instrument dialog*, and *Sivision dialog* in the *Standard Start dialog* operating mode.

In the *EasyMode Start dialog* operating mode, the program change keys *Chair* and *Instrument* can be used to switch to the relevant sub-screens.

Depending on which main dialog or sub-dialog is displayed, the LED of the corresponding program change key will light up.

It is not possible:

- to switch to the Instrument dialog or the sub-dialog of an instrument when no instrument has been removed
- To switch to the Sivation dialog when the PC connection is turned off or has not been configured

You can change from sub-screens and settings screens to a main dialog by touching one of the three program change keys in the *EasyMode Start dialog*.

#### 4.5.4.3 Timer function

A set time can be counted down to zero with the timer function. Four timers can be preset. A time loop (automatic restart of the countdown) and an acoustic signal (after the set time has elapsed) can be added to each timer.

##### Presetting the timer

The maximum time setting is 9 minutes and 30 seconds.

1. Press and hold the *Timer fixed* key on the dentist element (> 2 s).

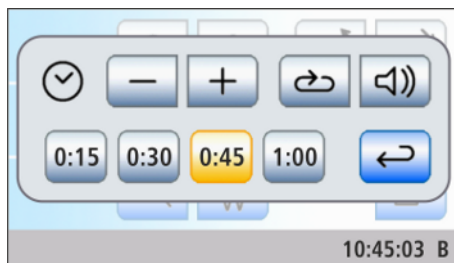

- ↳ The *Timer function* program is displayed on the touchscreen.



2. Select one of the four timers to change its presetting. To do this, touch one of the selection keys at the lower edge of the setting program.

- ↳ The selected timer is highlighted orange.

3. Use the – and + keys to set the required time.

Increments:

From 00:05 to 1:00 = 5 s steps

From 1:00 to 3:00 = 10 s steps

From 3:00 to 9:30 = 30 s steps

4. Select whether the time loop and the acoustic signal should be activated/deactivated for the selected timer. Touch the *Time Loop* and/or *Acoustic Signal* key.



- ↳ If a function is switched on, the corresponding key is highlighted orange.

5. Select another timer for adjustment or close the settings screen with the *Return* key.



- ↳ All settings are automatically saved when the screen is closed.

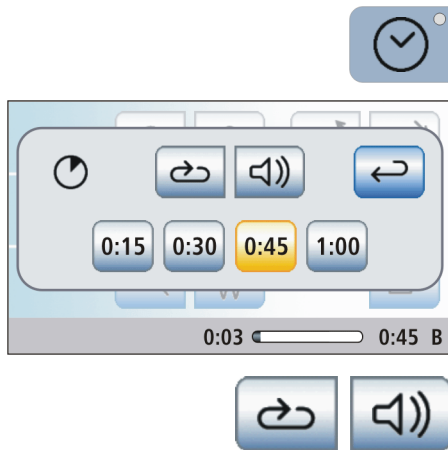

### Starting the timer

1. Press the *Timer* fixed key briefly.

↳ The most recently set timer is started immediately. The set and elapsed time are displayed in the status bar. The *Timer function* program is also displayed.

2. If you wish to use a different timer, touch one of the timers at the lower edge of the screen.

↳ If the already elapsed time is less than the new time set, the new time will be shown in the status bar. The started timer will not be reset to zero.

3. Optional: You can switch the time loop and/or acoustic signal on/off while the timer is counting down. Touch the *Time Loop* and/or the *Acoustic Signal* key.

↳ If a function is switched on, the corresponding key is highlighted orange.

### Stopping/resetting the timer



When the *Timer function* program is hidden, the timer can also be stopped by pressing the *Timer* fixed key. When the program is shown, the timer will be reset to zero.

#### 4.5.4.4 Shock positioning

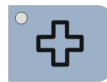

Immediately moves the patient chair to a position for shock positioning of the patient.

To program the position of the shock positioning function, see "Creating chair programs and shock positioning" [→ 75]

#### 4.5.4.5 Operating light

##### Switching the operating light on/off



> Briefly press the *Operating light* fixed key on the dentist or assistant element.

↳ When the operating light is switched on, the LED of the fixed key lights up on the dentist and assistant elements.

For details, see section "Operating light" [→ 171].

#### 4.5.4.6 Composite function



The composite function delays the curing of composite materials.

> Press the *Composite Function* fixed key.

↳ If the composite function is switched on, the LED of the fixed key lights up on the dentist and assistant elements. The *Operating light* key on the assistant element lights up.

#### 4.5.4.7 Tumbler filling

If the tumbler filling system of your treatment center is equipped with automatic sensor control, see "Tumbler filling with automatic sensor control" [→ 160].

### Filling the tumbler

1. Place the tumbler under the tumbler filler.

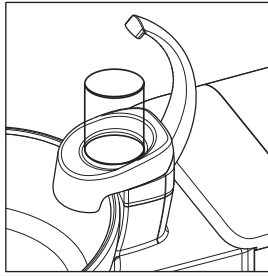

2. Press the *Tumbler Filling* fixed key.  
↳ The tumbler is filled with water for the preset time.

Pressing the *Tumbler Filling* fixed key again stops the filling function immediately.

### Opening the settings screen

- > Press and hold the *Tumbler Filling* fixed key (> 2 s).

↳ The *Tumbler Filling* settings screen is displayed.



### Linking tumbler filling to the mouth rinsing position and setting the filling time

1. Touch the *Link tumbler filling to mouth rinsing position* key.  
↳ If the key is marked orange, the tumbler filling function will automatically be switched on for the duration of the preset filling time when the mouth rinsing position chair program (S) is activated.
2. Use the – and + keys to set the filling time.

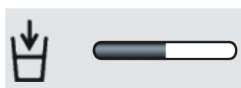

Since the setting *Tumbler filling with automatic sensor control* regulates the water volume via the **filling level**, systems with this option do not allow for setting the **filling time**, see "Tumbler filling with automatic sensor control" [→ 160].

### Water tempering on/off

- > Switch the tumbler tempering function on/off. Touch the *Water Tempering* key.  
↳ If the key is highlighted orange, the tumbler tempering function is activated.



#### 4.5.4.8 Flushing of the cuspidor bowl

The flushing function can be used for rough cleaning of the cuspidor during treatment.

### Switching the flushing on/off



- > Press the *Flushing* fixed key.
  - ↳ The LED in the key lights up during the flushing function. The flushing function is activated for the preset flushing time.

### Setting the flushing time



1. Press and hold the *Flushing* key on the dentist element (> 2 s).
  - ↳ The *Flushing* settings screen appears on the touchscreen.
2. Set the flushing time with the + and – keys.

### Link flushing to mouth rinsing position S

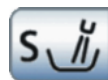

- > Touch the *Link flushing to mouth rinsing position S* key.
  - ↳ If the key is marked orange, flushing is automatically activated for the duration of the flushing time set when approaching the mouth rinsing position S.

#### 4.5.4.9 Freely selectable function

##### Bell



E.g. call key

Freely available relay 240 V, 6 A  
(connected by service technician)

This function can be preset as a pushbutton or as a switch in the Setup dialog, see "Setting the bell/hash key as a pushbutton or as a switch" [→ 196].

##### Hash



Freely available relay 240 V, 6 A  
(connected by service engineer).

This function can be preset as a pushbutton or as a switch in the Setup dialog, see "Setting the bell/hash key as a pushbutton or as a switch" [→ 196].

#### 4.5.4.10 Clean



Pressing this key deactivates the complete user interface of the dentist element with the exception of the standby switch. Pressing the key again > 3 s or stepping on the foot switch reactivates the user interface.

This is used to make sure that no unwanted functions can be accidentally triggered while cleaning the surface, see "Disinfecting the EasyTouch" [→ 208].

#### 4.5.4.11 Setup



Used for individual configuration of the treatment center by the user and for reading out messages by the service engineer, see "Configuration of the treatment center (Setup)" [→ 191].

### 4.5.5 Quick setting keys and function levels

Depending on which instrument is taken from the holder, the corresponding instrument dialog or respective functions appear in the EasyMode Start dialog.

#### Instrument programs in the Standard Start dialog operating mode

In the *Standard Start dialog operating mode*, the instrument settings can be made with static quick setting keys, programmable quick setting keys, or function levels.

#### Static quick setting keys

The values shown on the quick setting keys can be selected by touching them briefly (< 1 s).

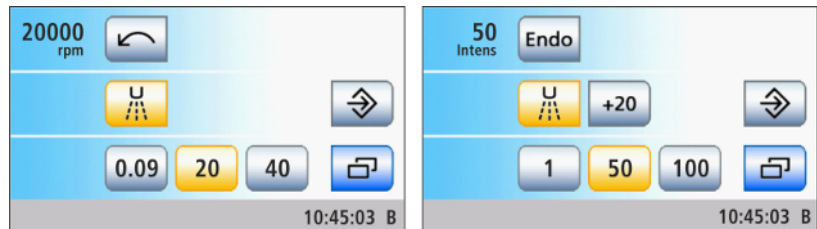

*Motor dialog (speed) and ultrasonic dialog (intensity) with static quick setting keys*

Intermediate values can be set as follows: If you press and hold (> 1 s) a quick setting key whose value is greater than or equal to the speed or intensity value displayed in the first line, the value increases. If you press and hold (> 1 s) a quick setting key whose value is less than the speed or intensity value displayed in the first line, the value decreases. The quick setting keys are shaded gray for intermediate values.

Static quick setting keys are displayed in the motor dialog with speed values (0.09 or 2, 20, 40 x 1000 rpm); in the ultrasonic dialog with intensity values (1%, 50%, 100%).

#### Programmable quick setting keys

The key values can be changed individually with the programmable quick setting keys.

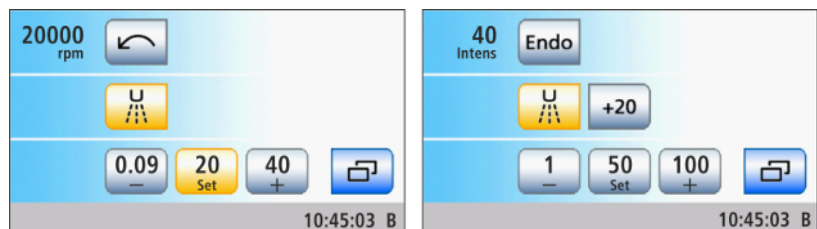

*Motor dialog (speed) and ultrasonic dialog (intensity) with programmable quick setting keys*

The speed/intensity shown in the first line can be increased or decreased by pressing and holding (>1 s) the left or right - or + quick setting key.

The programming mode is activated by holding down the middle quick setting key *Set* (> 2 s). The speed/intensity flashes on the touchscreen and a flashing bar appears behind the quick setting keys. Now press the quick setting key to which the set value is to be saved. A signal sounds as confirmation. Further settings such as activation of the coolant or Endo mode are also saved on the quick setting key.

The settings can be recalled by touching the respective quick setting key.

### Function levels

When using function levels, you have two "storage locations" (E1/E2) at your disposal for saving settings or recalling them at the push of a button. These settings can nevertheless be changed during treatment.

A distinction is made between a coarse and fine adjustment of the settings for speed and intensity. If the – or + key is touched briefly (< 1 s), the increments correspond to the quick setting keys (speed: 0.09 or 2, 20, 40; intensity: 1, 50, 100). If the – or + key is held (> 1 s), intermediate values can also be set.

The key is displayed in gray if the values saved in the function level have been changed ("Function level no longer valid").

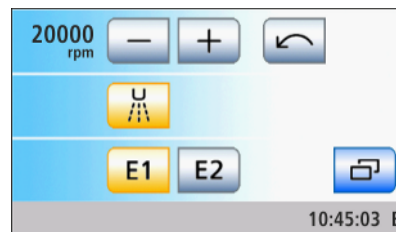

Motor dialog with function levels

### Using quick setting keys or function levels

You can decide whether you wish to work with static quick setting keys or the function levels in the setup dialog, see "Preselecting how instrument settings are to be saved" [→ 199]. The setting applies for each user profile A-F.

### EasyMode Start dialog

In the *EasyMode Start dialog*, only the quick setting keys are used to adjust the values for the speed and intensity (1%, 50%, 100%). The quick setting keys with the values for intensity are also displayed in the motor and ultrasonic programs when the endodontics function is activated. The operating concept corresponds with other Dentsply Sirona treatment centers that have membrane keys.



Start dialog in EasyMode with instrument functions for motor and ultrasonic (active endodontics function)

Intermediate values are set in the same way as in the *Standard Start dialog* operating mode, see above.

## 4.5.6 Saving instrument settings

### With static quick setting keys

You can determine whether the *Memory* key should be displayed in the instrument programs with the quick setting keys, see "Preselecting how instrument settings are to be saved" [→ 199].

#### SaveMode

- SaveMode – The *Memory* key is displayed in the instrument programs:

The settings made in the Instrument dialog will be saved after the instrument is placed in its holder only if the *Memory* key was pressed and held beforehand (> 2 s).

After an instrument is removed, the previously saved settings are preset again.

- ✓ An instrument is removed from its holder.
- ✓ The instrument dialog is displayed with static quick setting keys and the *Memory* key.
- ✓ The desired settings are made; see also "General instrument functions" [→ 92].

1. Only in the *EasyMode Start dialog* operating mode: Touch the *Sub-dialog* key.

2. Press and hold down the *Memory* key.

- ↳ An acoustic signal sounds. The settings in the Instrument dialog and its sub-dialog are saved.



#### DropMode

- DropMode – *Memory* key hidden in Instrument programs:

When the instrument is deposited, the settings made in the Instrument dialog are automatically saved.

The DropMode is not available in the *EasyMode Start dialog* operating mode.

### With programmable quick setting keys

With programmable quick setting keys, the set speed and intensity values can be saved to and called up from one of the quick setting keys. The settings for selecting and activating the coolant are saved at the same time.

- ✓ An instrument is removed from its holder.
- ✓ The instrument dialog is displayed on the touchscreen with quick setting keys.
- ✓ The coolant is preselected and, if relevant, activated, see "Preselecting coolant" [→ 92] and "Switching preselected coolant on/off" [→ 92].

1. Keep the middle quick setting key *Set* held down (> 2 s) to save the setting.

- ↳ The programming mode is activated. The speed flashes on the touchscreen and a flashing bar appears behind the quick setting keys.

2. Press one of the quick setting keys. This must be done within 5 seconds otherwise the programming mode is closed.

- ↳ An acoustic signal sounds. The set speed and preselection and activation of the coolant are saved on the quick setting key.





3. Repeat this process for other quick setting keys if necessary.
  - ↳ The settings can be recalled by touching the respective quick setting key.

#### With function levels

The settings which have been made can be saved to and recalled from two function levels (E1, E2). These settings can nevertheless be changed during treatment.

- ✓ An instrument is removed from its holder.
- ✓ The Instrument dialog with function levels is displayed on the touchscreen.
- ✓ All settings are made; see also "General instrument functions" [→ 92].



1. Press and hold key *E1* or *E2* (> 2 s).
  - ↳ An acoustic signal sounds. The settings in the Instrument dialog and its sub-dialog are saved to the corresponding function level.
2. Repeat this procedure for the second function level.
  - ↳ The settings can be recalled by briefly touching the key (< 2 s).

### 4.5.7 Placing the instruments in their holders

#### Automatic opening of instrument dialogs

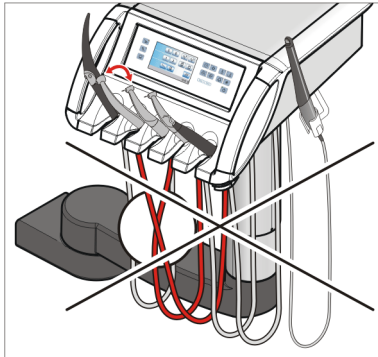

In the *Standard start dialog* operating mode, the touchscreen will automatically display the instrument dialog of the removed instrument. In the *EasyMode start dialog*, the touchscreen will display the speed or intensity values of the removed instrument.

If more than one instrument is removed, the instrument dialog or the speed or intensity values of the instrument removed first are displayed.

When using the Sinius or Sinius TS dentist element, make sure that the instruments are always placed in the correct instrument holders. If any instruments are placed in the wrong holders, the wrong instrument dialog will be opened when they are removed from the holders.

#### Sinius CS dentist element

Springs in the dentist element pull the swivel arm back into its original position to prevent the instrument hoses from hanging down.

- > Remove the required instrument from its holder and pull it toward you.
  - ↳ The swivel arm is pulled forward along the instrument hose. The touchscreen displays the instrument dialog or the speed or intensity values corresponding to the instrument. The instrument can be activated via the foot control.

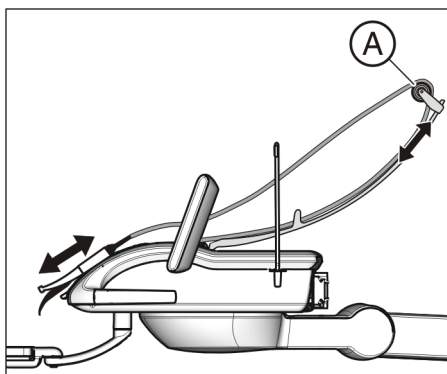
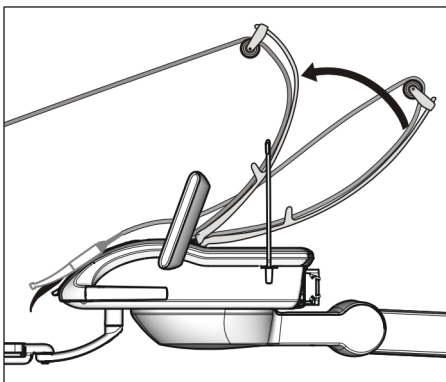

The positions of the instruments on the holder can be optimized by moving the guide rollers **A** on the swivel arms.

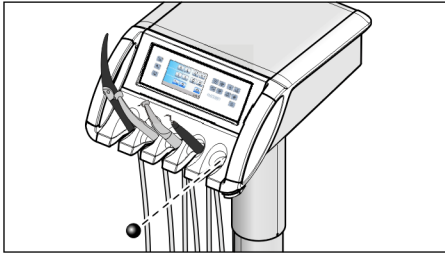

### Ball stopper for the Sinius and Sinius TS dentist element

A ball stopper can be ordered as an accessory for an unassigned instrument holder.

Insert the ball stopper into an unassigned instrument holder. This prevents accidental deposit of an instrument in this holder.

To reorder the ball stopper, see "Spare parts and consumables" [→ 285].

### Instrument hoses

#### NOTE

**The instrument hoses contain electrical cables and media pipes.**

Over-tensioning or pinching the hoses may cause the electrical cables to break and the media pipes to leak.

- Ensure that you do not pull or bend the instrument hoses too much.

### 4.5.8 General instrument functions

Settings for the coolant, instrument light, and foot control can be made in the sub-screen of the instrument removed from the holder.

The sub-screens vary according to the instrument removed. Functions not available for the respective instrument are not displayed in the sub-screen.

#### 4.5.8.1 Opening the sub-screen

- ✓ An instrument is removed from the holder.
- ✓ In the *Standard Start dialog* operating mode, the touchscreen will display the *Instrument dialog* of the instrument in use. In the *EasyMode Start dialog*, the values for the speed and intensity of the removed instrument are shown.
- > *Standard Start dialog*: Touch the *Sub-dialog* key.  
*EasyMode Start dialog*: Press the *Instrument* program change key.

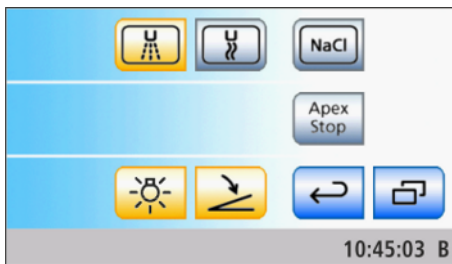

- ↳ The sub-dialog is displayed.

#### 4.5.8.2 Selecting a coolant

Air, spray or NaCl can be preselected as the instrument coolant in the sub-dialog. The preselected coolant can then be switched on or off in the Instrument dialog.

- ✓ The *Sub-dialog* of the removed instrument is displayed on the touchscreen.
- > Select the coolant required for the instrument removed from the holder. Touch the *Spray*, *Air* or *NaCl* key.
  - ↳ The key of the preselected coolant is highlighted orange. The key of the preselected coolant is displayed in the *Instrument dialog* or *EasyMode Start dialog*.



#### 4.5.8.3 Switching the preselected coolant on/off

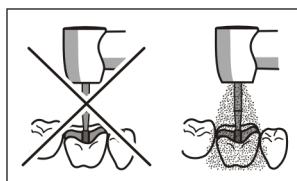

#### ⚠ CAUTION

**Instruments can be operated without coolant.**

Tooth substance can be damaged by frictional heat.

- > Always make sure that the treatment area does not overheat whenever you switch the coolant off. Effective cooling is achieved only with spray or NaCl solution (at least 50 ml/min).

### Via touchscreen

The preselected coolant in the *EasyMode Start dialog* operating mode can only be turned on/off with the foot control buttons, see below.



- ✓ An instrument is taken from the holder and the *Instrument dialog* is displayed on the touchscreen.
- > Touch the key of the preselected coolant (*spray*, *air* or *NaCl*).
  - ↳ If the key of the preselected coolant is highlighted orange, it will be switched on together with the instrument when the foot pedal is activated. If the key is highlighted gray, the coolant is switched off.

### Via foot control

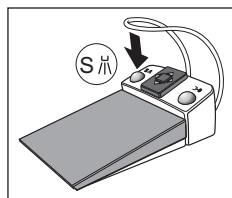

- ✓ An instrument is removed from its holder.
- > Press the left button of the foot switch.
  - ↳ If the key of the preselected coolant (*spray*, *air* or *NaCl*) is highlighted orange on the touchscreen, it will be switched on together with the instrument when the foot pedal is activated.

#### 4.5.8.4 Setting the ApexLocator



If your treatment center is equipped with the ApexLocator option, you can adjust this in the *Motor* sub-dialog. For more information, refer to the chapter "ApexLocator" [→ 118], section "Endodontic treatments with motor". For more information, refer to the chapter "ApexLocator" [→ 118], section "Implantology/endodontic treatments with motor" [→ 115].

The ApexLocator can only be used in the *Standard Start dialog* operating mode.

#### 4.5.8.5 Switch instrument light on/off



- ✓ The *sub-dialog* of the removed turbine of a motor or scaler is displayed on the touchscreen.
- > Switch the instrument light on or off with the *Instrument light* key.
  - ↳ If the key is highlighted orange, the instrument light can be activated using the foot pedal.

For high-speed handpieces, the brightness and operating voltage of the instrument light can be set, see "Setting the handpiece light" [→ 104].

The instrument light of the Sprayvit M multifunctional syringe can be adjusted separately, see "Switching the instrument light on/off and setting the water temperature" [→ 102].

#### 4.5.8.6 Setting the foot control as a direct starter or speed foot control

The foot control can be set as a direct starter or as a speed foot control in a motor or SiroSonic TL scaler sub-dialog:

- Direct starter
  - When the foot control is actuated, the instrument is switched on with the set speed and intensity.
- Control foot control

Depending on the setting of the foot control, the instrument controls the speed and intensity continuously up to the maximum value set.

- ✓ The *sub-dialog* of the removed instrument is displayed on the touchscreen.
- Touch the *Direct starter/control foot control* key.
  - ☞ If the key is highlighted gray, the direct starter function is switched on. If the key is highlighted orange, the speed foot control function is switched on.

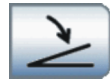

#### 4.5.8.7 Setting the spray amount

The spray amount is preset at the factory. However, it can be adjusted using the regulating screw on the dentist element. This setting is then valid for all burr drives.

#### Sinius and Sinius TS dentist elements

1. Set the spray amount by turning the screw at the bottom of the dentist element.
2. Check the set spray amount with a burr drive. Correct the setting if necessary.

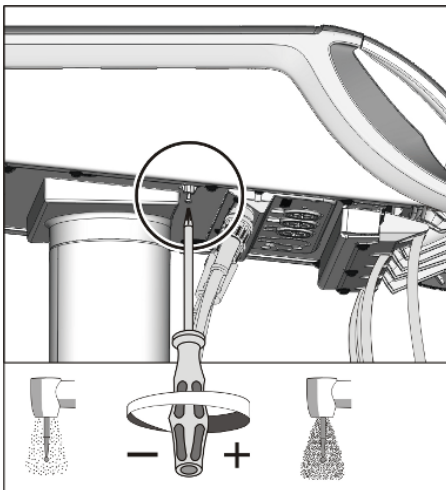

#### Sinius CS dentist element

The regulating screw for setting the spray amount is located below the instrument holder. The holder is fixed on the front edge with two internal clamps on the dentist element.

1. The instruments must be removed from the instrument holder. To do this, remove all instruments one after the other and allow these to hang down facing forward.
2. Lift the instrument holder by the front edge until the clamps are released and the holder can be removed.

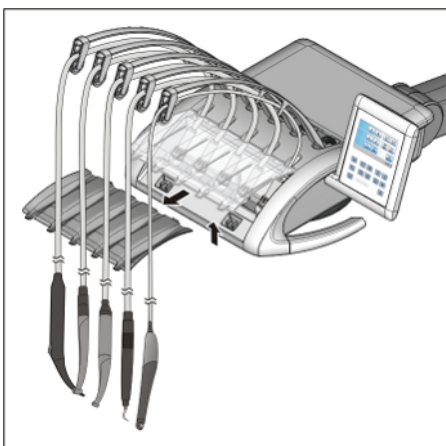

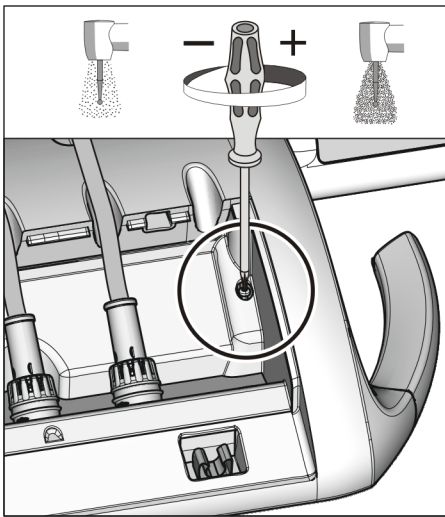

3. Set the spray amount by turning the screw.
4. Check the set spray amount with a burr drive. Correct the setting if necessary.
5. First insert the rear edge of the instrument holder into the groove on the dentist element. Then push the holder forward and down until it clicks into place.
6. Place the instruments in their holders. Make sure that the instrument hoses are located in the guide rollers of the swivel arm.

#### 4.5.8.8 Preparing for use of NaCl saline solution

A sterile saline solution instead of spray water is prepared for cooling via the peristaltic pump.

The peristaltic pump hose is a disposable item. To reorder it, see "Spare parts and consumables" [→ 285].

Two symbols are on the NaCl pump.

Meaning: When operating the unit, observe the instructions for use.



Meaning: Caution, risk for fingers in contact with moving parts

Close cover A before operating the NaCl pump.

✓ The drive of the peristaltic pump and a receptacle for the NaCl bottle holder are attached to the dentist element. Please contact your local distributor if necessary.

✓ A new peristaltic pump hose is available.

1. Attach the NaCl bottle holder to the dentist element.
2. Hang the NaCl bottle (max. 1 liter) onto the bottle holder.

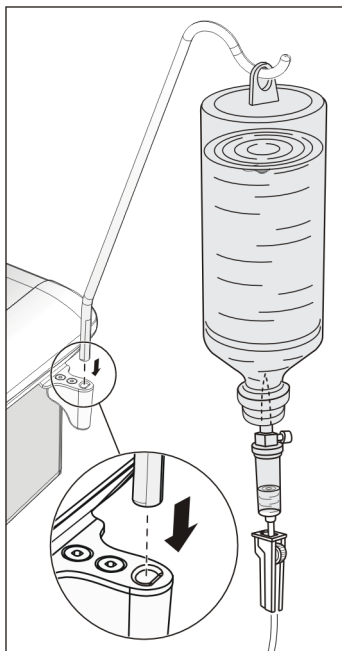



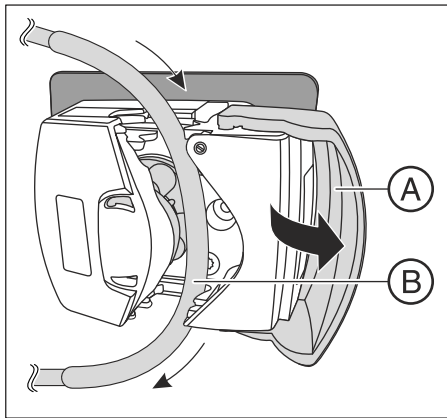

- Open cover **A**. Lay the silicone hose **B** without prestress, with the thickened part wrapped around the pump wheel. See the adjacent drawing. Close cover **A**.

### IMPORTANT

#### Direction of flow of the peristaltic pump

The shorter end of the hose with the cannula must be at the **top** of the pump, the longer end of the hose that goes to the handpiece at the **bottom**. See the adjacent drawing.

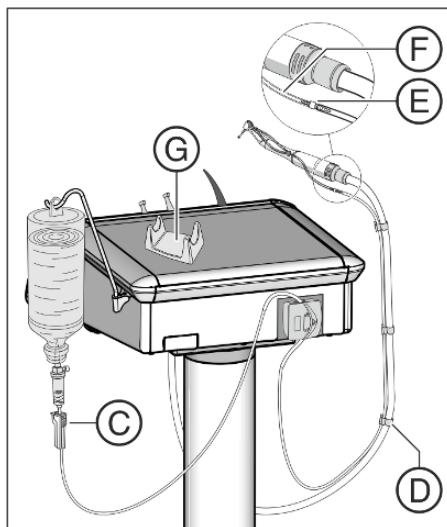

- Push the short end of the hose with the cannula through the stopper and into the NaCl bottle. The regulator in the hose clip **C** must be completely open (regulating wheel in top position).
- Run the long end of the hose alongside the corresponding motor hose up to the contra-angle handpiece. Fasten the hose with clips **D**.
- Attach the coupling **E** to the hose. Connect the thin silicone hose **F** to the coupling **E**.
- Connect the thin silicone hose **E** to the connectors on the contra-angle handpiece. For details, see the instructions for use of the contra-angle handpiece.
- Place the contra-angle handpiece on the separate motor holder **G**.

See also the descriptions in section "Preparing the treatment center for sterile operation" [→ 138].

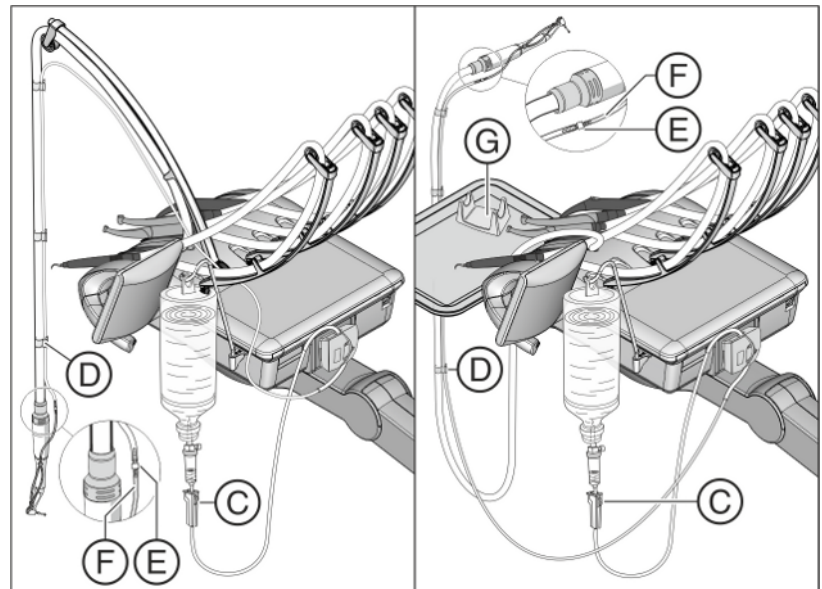

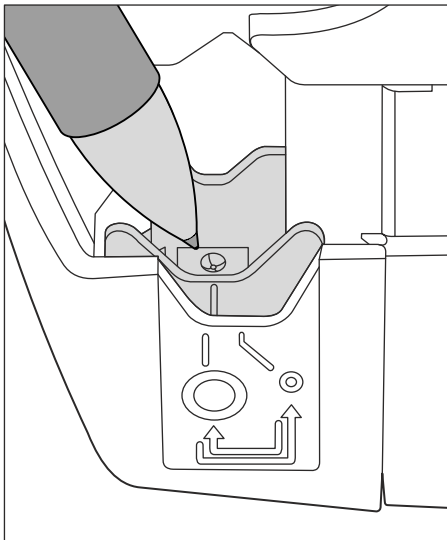

The NaCl pump has two settings for peristaltic pump hoses of different diameters. For the Dentsply Sirona peristaltic pump hoses, the wide setting must be selected. This ensures an optimal supply rate. The NaCl pump is therefore delivered with the wide default factory setting.

The hose setting can be changed when needed by pressing on it with a pen. The setting must always be adjusted on both sides.

#### 4.5.8.9 Setting the NaCl flow rate

- ✓ An instrument is removed from its holder.
  - ✓ In the *Standard Start dialog* operating mode, the *Instrument dialog* of the removed instrument is displayed on the touchscreen and NaCl is preselected as the coolant, see "Preselect coolant" [→ 92]. In the *EasyMode Start dialog*, the *sub-dialog* of the removed instrument is displayed.
1. In the *Standard Start dialog*, keep the *NaCl* key pressed (> 2 s). In the *EasyMode Start dialog*, keep the *Preselect NaCl* key pressed (> 2 s).

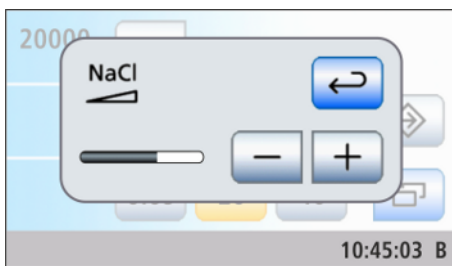
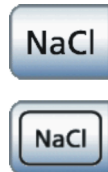

2. Use the – and + keys to set the flow rate of the NaCl pump.
  - ↳ The *NaCl* settings screen is displayed.
3. Touch the *Return* key.
  - ↳ The *NaCl* settings screen is hidden immediately. The settings are saved. If the *NaCl* key is highlighted orange, the function is activated.

#### NOTE

**Ultrasonic scaler tips of third-party manufacturers do not always have a sufficient flow rate in conjunction with the NaCl function.**

- Use only ultrasonic scaler tips from Dentsply Sirona. See also the SiroSonic TL instructions for use.

## 4.5.9 Multifunctional syringe Sprayvit M

The Sprayvit M multifunctional syringe is used for dental treatment with air and heated/unheated water. The Sprayvit M multifunctional syringe is also used to illuminate the preparation field.

The heating cartridge for the water is located in the handpiece.

### 4.5.9.1 Structure

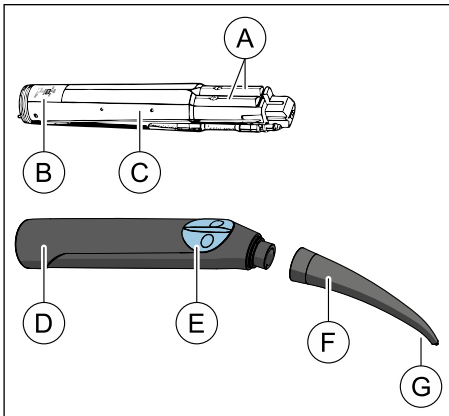

A	Media lever	
B	SN xxxxxx	Serial Number
	20xx	Year of manufacture
C	Valve body	
D	Housing	
E	Keyboard	
F	Nozzle	
G	Light aperture	

### 4.5.9.2 Product labeling



Can be thermally  
disinfected



Sterilizable at  
135°C



Date of manufac-  
ture



Serial Number



Order number

### 4.5.9.3 Media supply

At the supply hose inlet, unit end:

Temperature of input medium in °C	18 ± 3
Water pressure in bar (flowing)	2 ± 0.1
Water flow rate in ml/min	≥130
Air pressure in bar (flowing)	3.2 ± 0.1
Air flow rate in NI/min	≥ 13

#### 4.5.9.4 Safety instructions

Protect yourself, the patient and any third parties from danger. To do this, observe the following safety information:

##### **WARNING**

**A small metal tube protrudes at the tip of the nozzle.**

Risk of injury and contamination!

- > Avoid contact with the tip of the nozzle. Do not attempt to handle with the nozzle attached.
- > Remove the nozzle after every patient and carry out reprocessing.

##### **IMPORTANT**

Air and water must be able to flow out of the nozzle freely. Do **not** place the nozzle against a tooth or other object. Do **not** press the nozzle into the impression material.

The Sprayvit M is equipped with extensive safety monitoring functions. However, please observe the following information.

##### **CAUTION**

**After changing the Sprayvit M hose, no cooling water for the Sprayvit M heating cartridge flows until the hose is completely filled.**

The patient may be scalded by the emission of hot steam. The heating cartridge can overheat and be destroyed.

- > After changing the hose of the Sprayvit M multifunctional syringe, press the *Water* key **briefly** and repeat until there is an ample supply of water in the hose before treating the patient.

##### **IMPORTANT**

**Heating cartridge switch-on delay**

To minimize the risk of scalding, the Sprayvit M water heater is not activated for several seconds after the treatment center is switched on and after a hose change when the *Water* key is initially pressed.

##### **CAUTION**

**If the flow rate is insufficient, hot water may be emitted by the Sprayvit M.**

The patient could thus be scalded.

- > Check the water flow rate prior to use.
- > Check the flow rate at least once a month and whenever you suspect that it may be insufficient as described in the section "Checking the flow rate of the Sprayvit M multifunctional syringe" [→ 229]. Clean the nozzle if required, see "Maintaining cooling nozzle outlet" [→ 228].

### IMPORTANT

#### Air outlet during hose change

If the Sprayvit M is removed from the instrument hose while the treatment center is in use, air will escape from the hose coupling. You should therefore switch off the treatment center before changing a hose.

### IMPORTANT

#### Electronic flow monitoring

If the electronic flow monitoring system detects low flow, the water heater will be deactivated and the system displays the corresponding error message, see also "Error messages" [→ 282].

#### 4.5.9.5 Connecting the instrument hose

### ⚠ CAUTION

#### Risk of electric shock

> Do not operate the media lever when the housing is removed!

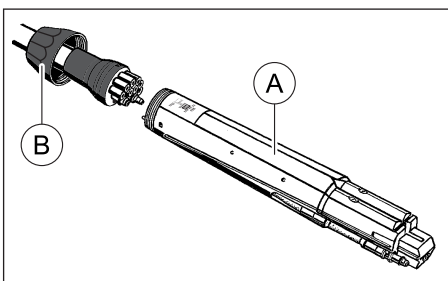

1. Attach the valve body (A) to the supply hose, observing the various tube diameters. The valve body may also remain in the housing.
2. Screw the cap nut (B) onto the valve body and tighten it.

#### 4.5.9.6 Attach/remove the housing and nozzle

##### Attaching

1. Align knob (A) and recess (B) so they face each other.
2. Attach the housing until it clicks into place.
3. Twist the nozzle onto the housing.
4. Check to make sure the nozzle is firmly attached.

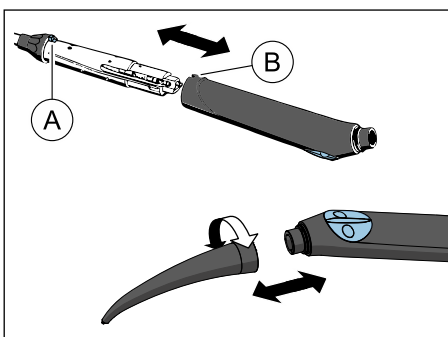

### ⚠ CAUTION

If the nozzle is not locked in place, it can come loose when the Sprayvit M is operated and fall into the patient's throat.

##### Removal

1. Twist the nozzle to detach it from the housing.
2. Press the lock knob and pull the valve body out of the housing at the cap nut. Do not hold or pull on the supply hose!

#### 4.5.9.7 Applying air, water, or spray

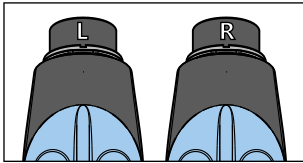

In the standard design, the water button for the Sprayvit M multifunctional syringe is located on the right. A Sprayvit M with inverted media (water on the left) is available as an option.

When the nozzle is taken out of the holder, you can see which design it is. If the water button is on the right, it is marked "R", for Sprayvit M with the water button on the left, "L".

The following instructions apply to the standard design of Sprayvit M (water on the right).

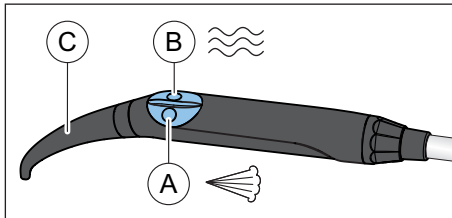

- > Press the *Air* key (A).
  - ↳ Air flows out of the instrument tip.
- > Press the *Water* key (B).
  - ↳ Water flows out of the instrument tip.
- > Press the *Air* key (A) and the *Water* key (B) simultaneously.
  - ↳ Spray flows out of the instrument tip.
- > Twist the nozzle (C) to reach the desired spray direction.

#### 4.5.9.8 Instrument light on/off and water temperature adjustment

The instrument light of the two Sprayvit M multifunctional syringes on the dentist and assistant elements can be switched on and off independently. The switching on/off refers to the multifunctional syringe that has been removed from the dentist element or the assistant element. If both multifunctional syringes are removed from their holders, the setting applies only to the multifunctional syringe of the dentist element.

If the Sprayvit M multifunctional syringe is not operated for 10 s, the instrument light automatically switches off.

The heating power of the water heater in the water unit is adjustable.

#### Switching the Sprayvit M instrument light on/off in the Start sub-dialog

✓ The *Start dialog* is shown on the touchscreen

1. Touch the *Sub-dialog* key.



↳ The *Start* sub-dialog is displayed.

2. Take a Sprayvit M multifunctional syringe from the holder of the dentist or assistant element.





↪ The *Sprayvit M instrument light* key is displayed in the *Start* sub-dialog.

3. Touch the *Sprayvit M instrument light* key.

↪ When the key is highlighted orange, the instrument light at the *Sprayvit M* multifunctional syringe is turned on if it is the only instrument to have been removed.

### Activating/deactivating and setting the water temperature in the *Sprayvit M* setup dialog

The heating power of the water heater in the water unit is adjustable. This accommodates different input temperatures of the supply water (e.g. summer/winter). The setting range is approx. 8 °C.

In order to prevent interference with the treatment process, the corresponding screen does not automatically appear on the touchscreen when the *Sprayvit M* is removed from its holder. It must be opened with the *Setup* key.

#### ⚠ CAUTION

**The heating power can be set too high.**

The patient then feels that the water is too warm.

- Adapt the heating power of the water heater to the inlet temperature of the water.
- Before using the *Sprayvit M* multifunctional syringe, check the water temperature, e.g. with the back of your hand.

✓ The *Sprayvit M* multifunctional syringe has been removed from its holder on the dentist or assistant element.

1. Press and hold the *Setup* fixed key (> 2 s).

↪ The *Sprayvit M* setup dialog is displayed.

Setup

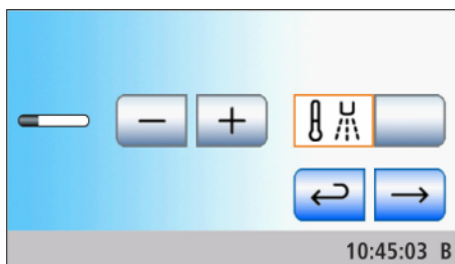

2. Touch the *Water temperature* key.

↪ If the key is highlighted orange, the water tempering function is activated.

3. Use the – and + keys to set the water temperature.

## 4.5.10 Highspeed handpiece

### 4.5.10.1 Using the highspeed handpiece



#### IMPORTANT

Also observe the operating instructions for the different high-speed handpieces.

The high-speed handpiece hose is equipped with a standardized coupling according to ISO 9168.

The coolant, spray, air, or NaCl can be preselected in the *High-speed handpiece* sub-dialog; see "General instrument functions" [→ 92].

If your treatment center is equipped with the proportional valve option, the driving air of the high-speed handpiece can be regulated using the foot control.

In the operating mode *EasyMode Start dialog*, the quick setting keys are shown, but they have no function.

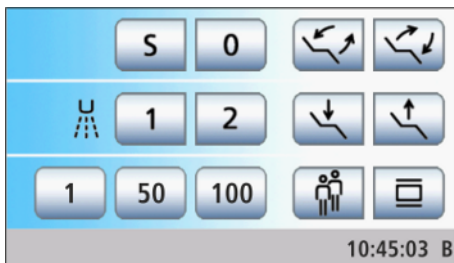

### 4.5.10.2 Setting the light of the highspeed handpiece

#### Opening the highspeed handpiece setup dialog

- ✓ The highspeed handpiece is removed from the holder.
- Press and hold the *Setup* fixed key (> 2 s).
  - ↳ The Setup dialog of the highspeed handpiece is displayed.

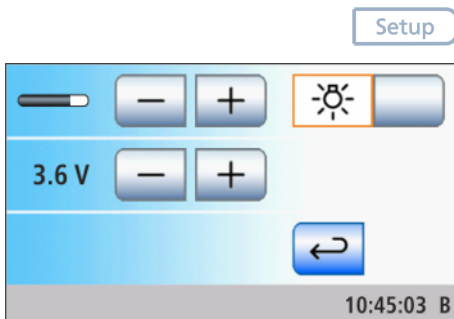

#### Adjusting the instrument light and switching it on/off

If the highspeed handpiece is equipped with an instrument light, it can be switched on/off and its brightness can be adjusted.

1. Use the – and + keys to adjust the brightness of the highspeed handpiece light.
2. Switch the highspeed handpiece light on or off with the *Instrument light* key.
  - ↳ If the key is highlighted orange, activating the foot control will switch on the highspeed handpiece light at the set brightness.





### Preselecting the instrument light operating voltage

The original Dentsply Sirona halogen and LED lamps are usually operated at 3.6 V. Voltages over 3.8 V destroy the lamp. The operating voltage can be adjusted for lamps made by other manufacturers.

#### NOTE

**The operating voltages of different lamps may vary.**

Overvoltages can lead to damage.

> When changing lamps, make sure that the operating voltage is properly set for the new lamp.



> Use the – and + keys to adjust the maximum operating voltage of the highspeed handpiece light.

## 4.5.11 Motor

The motor drives rotating and oscillating straight and contra-angle handpieces. Depending on the model, the motor may also be used for endometric measurements.

The motors meet the ISO 14457 standard.

### 4.5.11.1 Motor versions

Different brushless motors are available depending on the type of use and the coupling of the handpiece.

Brushless motors are designed as three-phase motors (without carbon brushes). They feature precise controllability and longevity.

For information on apex measurements using the instrument, refer to the section "Preparing to use the ApexLocator" [→ 119].

For reprocessing the motors, please refer to the section "Disinfecting/sterilizing motors and adapters" [→ 230].

#### Hose coding

The motors each have a special instrument hose with electrical coding. The treatment center recognizes the connected motor using this and configures the control system accordingly. It is not possible mix up the different versions due to mechanical coding on the hose and motor.

#### BL motor

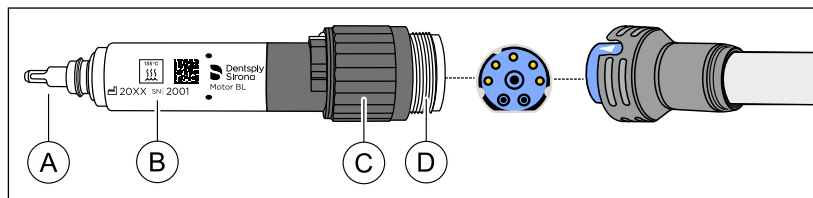

A	Motor shaft including carrier
B	Product labeling
C	Control ring/lamp ring
D	Coupling connection (blue / 3 guide lugs)

The BL motor is designed for direct operation of T1 Classic handpieces. In order to use the straight and contra-angle handpiece with an ISO interface, either the ISO adapter (no apex measurement, spray) or the Basic Apex adapter (apex measurement, no spray) have to be used as a connector.

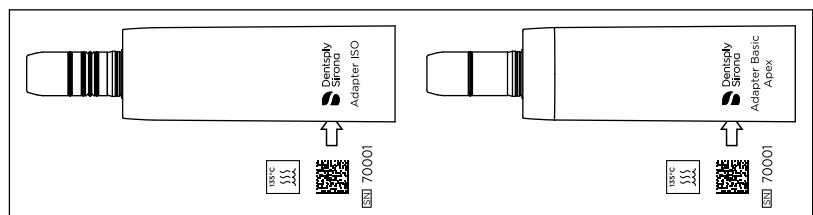

ISO adapter (left) and Basic Apex adapter (right)

Their speed range lies between 90 and 40,000 rpm (revolutions per minute).

### BL ISO C/E motors

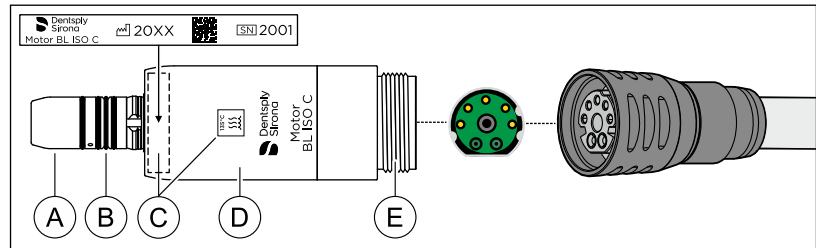

A	Handpiece holder
B	O-ring 8.4 x 0.7
C	Product labeling
D	ISO C/E motor sleeve
E	Coupling connection (green / 3 guide lugs)

The BL ISO C/E motors are equipped with an ISO interface. This allows all straight and contra-angle handpieces with an ISO interface to be used without an adapter.

The motor housing and the ISO interface of the motors are shortened.

The speed of the BL ISO C motor ranges between 90 and 40,000 rpm; the speed of the BL ISO E motor ranges between 2,000 and 40,000 rpm.

The BL ISO C motor can be used for endodontic treatment.

### BL Implant motor

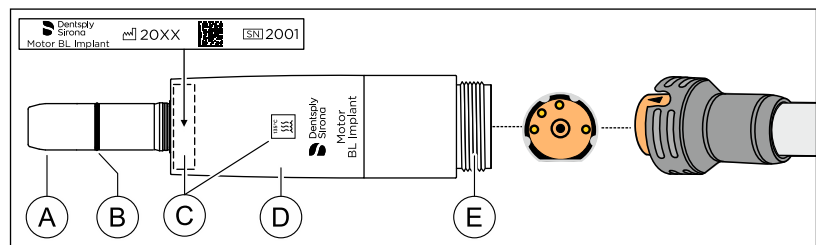





A	Handpiece holder
B	O-ring 8 x 1
C	Product labeling
D	Implant motor sleeve
E	Coupling connection (yellow / 4 guide lugs)

The BL Implant motor has been specially designed for surgical use. The air/water supply (spray) and the instrument light are therefore not present. It has a very high torque.

The speed range lies between 90 and 40,000 rpm.

#### 4.5.11.2 Product labeling

The motors or the motor sleeves and the adapters are labeled with the following information:

	Manufacturer and product name		Sterilizable at 135°C
	Year of manufacture		Data Matrix code
	Serial number		

#### 4.5.11.3 Technical Data

##### Motors

	BL	BL ISO E/C	BL Implant
Length in mm	~ 40	~ 45	~ 61
Max. diameter in mm	~ 16	~ 22	~ 22
Max. speed in rpm	~ 40000	~ 40000	~ 40000
Torque in N/cm	~ 2.4	~ 3.0	~ 5.0
Limiting current in A, short term	~ 7	~ 7	~ 7
Max. power in W	~ 45	~ 61	~ 80
Spray function	x	x	-
Light function	x	x*	-
Apex measurement function	x	x	-
Handpiece holder – ISO 3964	-	x	x

\* INTRAmatic Lux® interface

##### Adapter for BL motor

	ISO adapter	Basic Apex adapter
Light function	x	x
Spray function	x	-
Apex measurement function	-	x
Handpiece holder – ISO 3964	x	x

##### Media supply

	BL and BL ISO E/C	BL Implant
Cooling air pressure in bar	2.2 - 3	2.2 - 3
Cooling air supply in l/min	20 ± 2.5	20 ± 2.5
Spray air pressure in bar	2.7 ± 0.2	–
Spray air flow in L/min	> 1.5	–

	BL and BL ISO E/C	BL Implant
Spray water pressure in bar	2 ± 0.2	–
Spray water flow in ml/min	> 100	–
Recommended water content in spray in ml/min	> 50	–

#### 4.5.11.4 Safety instructions

##### **⚠ CAUTION**

###### **Risk of injury when changing the hose**

- > Do **not** detach the motor from the instrument hose during operation!

##### **⚠ CAUTION**

###### **Prevent eye damage**

The LED is in risk class 2 according to the IEC 62471:2006 standard. The LED emits optical radiation that is potentially hazardous and may be harmful to the eyes. Potential damage to the retina from the blue light emission.

- > Do **not** look at the LED for longer periods of time while in operation.

##### **NOTE**

###### **Protecting the motor shaft/axis**

A bent motor shaft on the BL motor causes irregular operating noises or strong vibrations. This can damage instruments.

- > Do **not** let the motor drop on the floor.

##### **NOTE**

###### **Motor cooling**

- > If the motor overheats under high load, let it cool off by idling at half speed before continuing treatment.
- > Never operate the motor without cooling air.

##### **NOTE**

###### **Never lubricate electric motors!**

- > Remove the handpieces from the electric motors at the end of the working day so that no oil can run into the motor overnight.

#### 4.5.11.5 Connecting the instrument hose

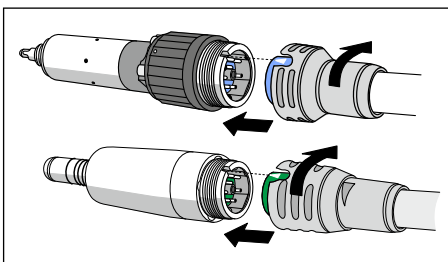

- ✓ Colored marks and position of guide lugs on motor and hose coupling of the instrument hose match.
1. Slide back the cap nut at the hose coupling.
  2. Attach the motor onto the hose coupling up to the stop, observing the contact pins and tubes. Make sure the hose coupling does not tilt.
    - ↙ The arrow on the hose coupling and the notch on the motor must face each other.

3. Press the cap nut gently onto the thread; then turn it counterclockwise until a faint click is heard.
4. Screw the cap nut tightly onto the motor **clockwise**.

Does water leak out between the motor and the hose connection?

1. Remove the motor from the instrument hose.
2. Reconnect the motor to the instrument hose. Make sure it is connected properly.
3. If water still leaks, replace the sealing washer.

#### 4.5.11.6 Replacing the instrument

##### CAUTION

The instrument should only be fitted or removed when the motor is at standstill.

#### Attaching the instrument / adapter to the BL motor

##### CAUTION

Do not operate the BL motor with exposed motor shafts and carriers (removed instrument / adapter). This may cause injury!

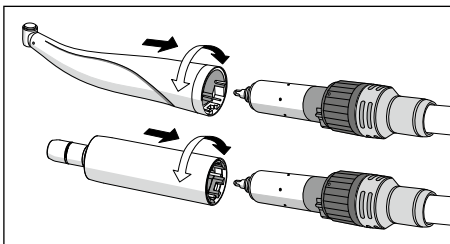

- ✓ The motor is at a standstill.
- Attach the instrument or adapter. Lock the instrument or adapter into place here by turning.

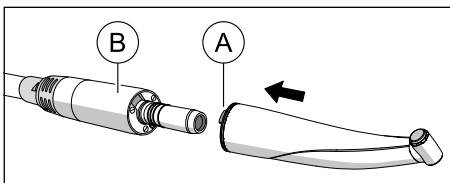

#### Attaching instrument to the BL ISO E/C motor or adapter

- ✓ The motor is at a standstill.
- 1. Align the nib **A** of the instrument with the groove **B** of the motor.
- 2. Insert the instrument until it snaps into place.

#### Attaching the instrument to the BL Implant motor

- ✓ The motor is at a standstill.
- Insert the instrument until it snaps into place.

#### Removing instrument/adapter

- ✓ The motor is at a standstill.
- Detach the instrument or adapter. Do not pull on the instrument hose while doing this.

#### 4.5.11.7 Adjusting the cooling spray

##### CAUTION

The BL Implant motor and basic adapter Apex do not provide cooling spray.

- > Ensure sufficient cooling of the preparation site via a sterile external media supply, e.g. NaCl.

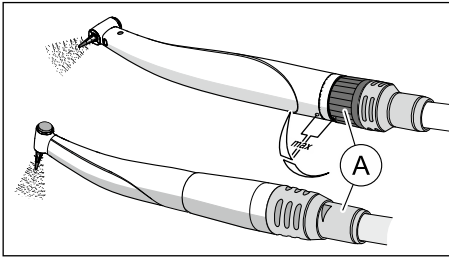

- > Adjust the flow rate of the cooling water using the control ring **A** (> 50 ml/min).

**Tip:** You can measure the amount of cooling water with a measuring cup and watch.

**BL motor:** The maximum water flow is set when the two marks are facing each other.

**BL ISO E/C motor:** The maximum water flow is set when the control ring at the instrument hose is turned in a counterclockwise direction until it reaches the stop.

#### 4.5.11.8 Setting the speed

In the *Standard Start dialog* operating mode, settings can be made using the static quick setting keys (with the key values 0.09 or 0.2, 20, 40), with programmable quick setting keys (with changeable key values), or via function levels (E1, E2).

In the *EasyMode Start dialog*, the speed can only be set using the static quick setting keys. They are displayed with intensity values (1%, 50%, 100%).

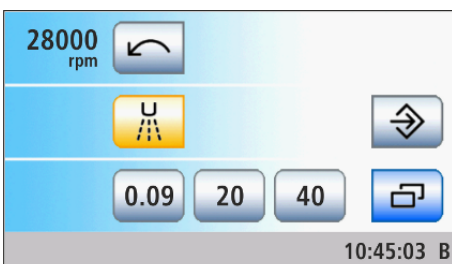
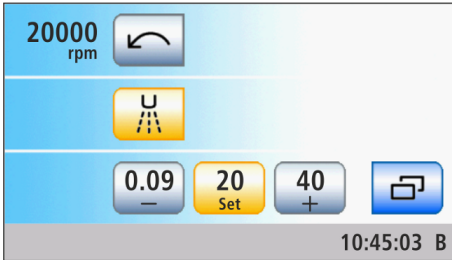
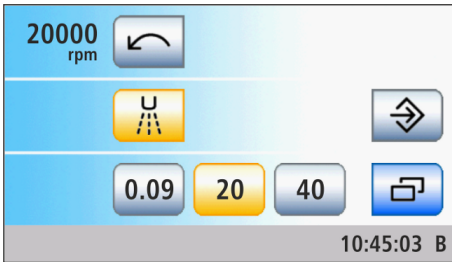

### Selecting the speed with the quick setting keys

- ✓ The electric motor is removed from the holder.
- ✓ Either the *Motor dialog* with static or programmable quick setting keys is displayed on the touchscreen or the *EasyMode Start dialog*.
- Touch one of the quick setting keys in the bottom line briefly (< 1 s).
  - ↳ The quick setting key is highlighted orange. The selected speed is displayed in the first line in rpm (revolutions per minute).

### IMPORTANT

#### Rpm values of quick setting keys

In the *Standard Start dialog* operating mode, the motor speed corresponds to the speed value of the key times 1000.

The 0.09 key = 90 rpm (for BL, BL ISO C, and BL Implant motors)

The 0.20 key = 200 rpm (for BL ISO S motors)

The 20 key = 20,000 rpm

The 40 key = 40,000 rpm

In the *EasyMode Start dialog* operating mode, the motor speed corresponds to the intensity of the key in percent.

Key 1 = 90 rpm (for BL, BL ISO C, and BL Implant motors)

Key 1 = 200 rpm (for BL ISO E motor)

Key 50 = 20,000 rpm

Key 100 = 40,000 rpm

Please note that the speed of the burr depends on the selected straight or contra-angle handpiece.

### Setting intermediate speed values with static quick setting keys

- ✓ The electric motor is removed from the holder.
- ✓ The *Motor dialog* with static quick setting keys or the *EasyMode Start dialog* is displayed on the touchscreen.
- Increase speed: Hold down a quick setting key, which has a speed value that is greater than or equal to the one displayed in the first line (> 1 s).
  - Decrease speed: Hold down a quick setting key, which has a speed value that is less than the one displayed in the first line (> 1 s).
  - ↳ The selected speed is displayed in the first line in rpm (revolutions per minute). The quick setting keys are shaded gray for intermediate values.



## IMPORTANT

### Increments

The size of the increments depends on the speed range setting.

For BL, BL ISO C and BL Implant motors:

From 90 to 400 rpm = 10 rpm increments

From 400 to 5,000 rpm = 200 rpm increments

From 5,000 to 40,000 rpm = 1,000 rpm increments

For BL ISO E motor:

From 200 to 2,000 rpm = 200 rpm increments

From 2,000 to 10,000 rpm = 400 rpm increments

From 10,000 to 40,000 rpm = 1,000 rpm increments

Please note that the speed of the burr depends on the selected straight or contra-angle handpiece.

### Setting intermediate speed values with programmable quick setting keys

- ✓ The electric motor is removed from its holder.
- ✓ The *Motor dialog* is displayed on the touchscreen with programmable quick setting keys.
- Press and hold the left or right quick setting key – or + (> 1 s).
  - ↳ The speed is increased or reduced.

For increments see "Setting intermediate speed values with static quick setting keys" (above).

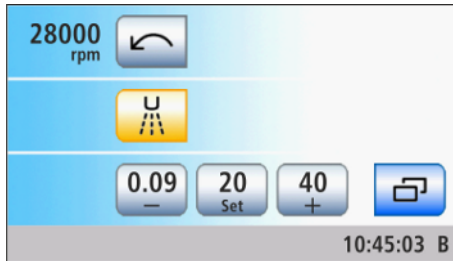

### Setting the speed with function levels

- ✓ The electric motor is removed from the holder.
- ✓ The *Motor dialog* with function levels is displayed on the touchscreen.
- Set the speed using the – and + keys.
  - < 1 s coarse adjustment, > 1 s fine adjustment
  - ↳ The selected speed is displayed in the first line in rpm (revolutions per minute).

For increments for coarse adjustment, see "Selecting the speed with the quick setting keys" (above).

For increments for fine adjustment, see "Setting intermediate speed values with the quick setting keys" (above).

### 4.5.11.9 Setting the direction of rotation

The direction of rotation can be changed only when the motor is at a standstill.

In the *EasyMode Start dialog* operating mode, the direction of rotation can only be set by using the foot control.

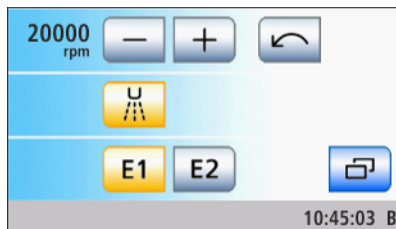

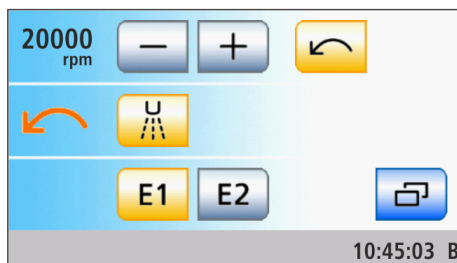
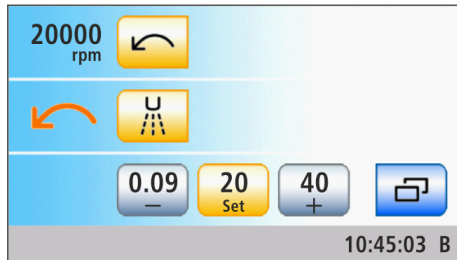
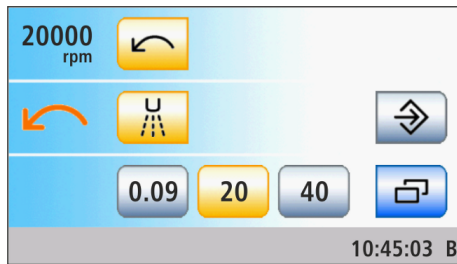

### Via touchscreen

- ✓ The *Standard Start dialog* operating mode is set.
- ✓ An electric motor is removed from the holder.
- ✓ The *Motor dialog* is displayed on the touchscreen.
- Touch the *Counterclockwise rotation* key on the touchscreen.
  - ↪ For counterclockwise rotation: The key is highlighted orange and an orange counterclockwise rotation arrow appears.
  - ↪ For clockwise rotation: The key is displayed in gray and the orange counterclockwise arrow is hidden.

### Via foot control

When the cursor control is switched off, the rotational direction of the motor can also be set via the 4-way control plate of the foot switch. In the *EasyMode Start dialog* operating mode, the direction of rotation must be set via the foot switch.

- ✓ An electric motor is removed.
- ✓ The *Motor dialog* or *EasyMode Start dialog* is displayed on the touchscreen.
- For counterclockwise rotation: Move the 4-way control plate to the left.
  - ↪ For clockwise rotation: Move the 4-way control plate to the right.
  - ↪ In the *Standard Start dialog*:
    - ↪ If the counterclockwise rotation is selected, the *CCW Rotation* key is highlighted orange and an orange counterclockwise arrow appears. If the motor is running in a clockwise direction, the *CCW Rotation* key is displayed in gray and the orange counterclockwise arrow is hidden.

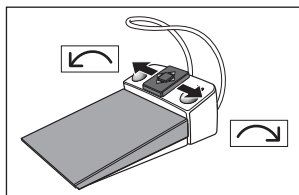

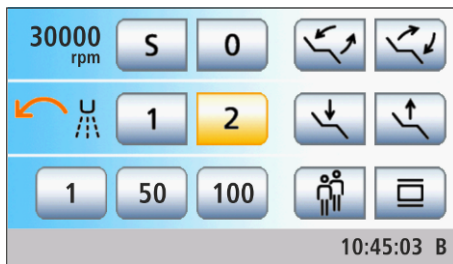

- ✎ In the *EasyMode Start dialog*:  
If counterclockwise rotation is selected, an orange counterclockwise arrow appears. The counterclockwise arrow disappears when clockwise rotation is selected.

**Tip:** After starting the electric motor with the foot switch, an audible warning signal sounds 6 times if counterclockwise rotation is activated.

#### 4.5.11.10 Implantology/endodontics treatments with motor

##### 4.5.11.10.1 Electronic torque limitation

If your treatment center is equipped with the implantology/endodontics software option, please observe the instructions provided in the chapter "Implantology and endodontic treatments" [→ 130]. If your treatment center is not equipped with this option, please note that you do not have the option of electronic torque limitation.

#### CAUTION

**No electronic torque limitation is available in the Motor dialog.**

Root canal files can easily break during operation without torque limitation.

- Never perform endodontic treatments without torque limitation. Use an endodontic handpiece with mechanical torque limitation, e.g. SiroNiTi from Dentsply Sirona.

##### 4.5.11.10.2 Endodontic treatments with the ApexLocator in the motor screen

If your treatment center is equipped with the ApexLocator option but does not have the treatment function, the Apex function in the Motor program can be used for endodontic treatments.

Please note that the ApexLocator can be accessed only in the *Motor program* in the *Standard Start program* operating mode.

#### IMPORTANT

##### SiroNiTi Apex

Only Dentsply Sirona SiroNiTi Apex must be used to perform apex measurement using a torque-limiting handpiece! The electrical conductivity can be ensured only using this handpiece.

The SiroNiTi handpiece can also be used to perform endodontic treatments without the ApexLocator.

- ✓ The treatment center is prepared for apex measurements using the instrument, see section "Preparing to use the ApexLocator" [→ 119].
  - ✓ The *Motor dialog* is displayed on the touchscreen.
1. Set the appropriate motor speed according to the handpiece and the root canal file used, see "Setting the speed" [→ 113].
  2. You can set the motor so that it stops automatically when the physiological apex is reached. If you want to use the automatic motor stop, this can be preset in the *Motor* sub-dialog. To do this touch the *Sub-dialog* key.



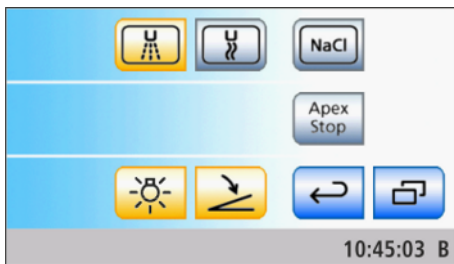

↪ The *Motor* sub-dialog is displayed.



3. Touch the *Apex stop* key.
  - ↪ If the key is highlighted orange, the motor stops automatically when the physiological apex is reached. The – and + keys and the *AutoReverse* key are displayed.
4. Use the – and + keys to set the required apex distance from 1.5 to 0. If the distance is 0, the motor does not stop until it reaches the physiological apex. Please note that the distance values are not a metric length measurement!

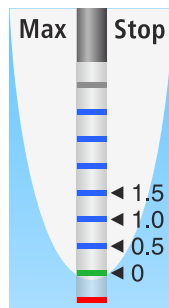
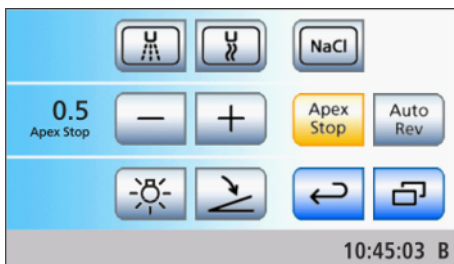

↪ The set distance is displayed to the left of the – and + keys. The preset motor stop position is displayed in the *Motor dialog* as a black triangle to the right of the distance display under the text "Stop".



5. To combine the automatic motor stop with the automatic switching to counterclockwise rotation, press the *AutoReverse* key.
  - ↪ If the button is orange, the motor automatically switches to counterclockwise rotation following the motor stop the next time the foot pedal is operated. When the file is withdrawn, the bur drive automatically switches back to clockwise rotation.
6. In the second *Motor* sub-dialog, the apex acoustic signals and apex distance signals can be switched on. To do this touch the *Sub-dialog* key.



↪ The second *Motor* sub-dialog is displayed.



7. To switch on the apex acoustic signals, press the *Apex acoustic signals* key.
  - ↪ If the key is colored orange, an acoustic signal is issued when the apex or the set motor stop position is reached. If the Auto-

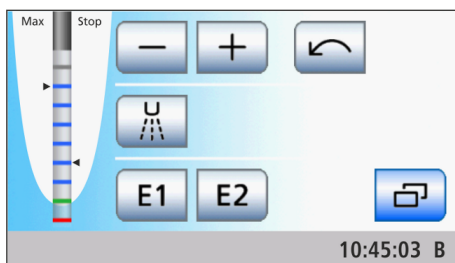
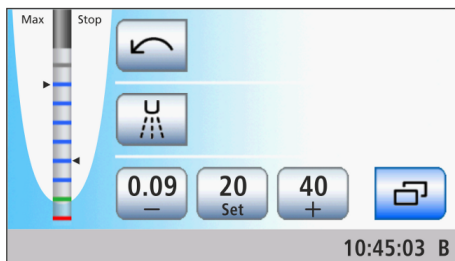
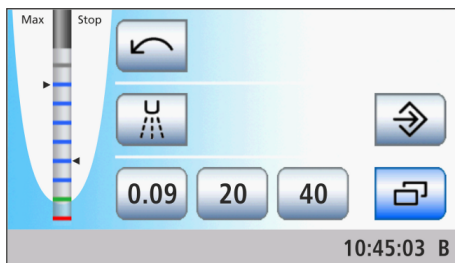

reverse function is activated, three acoustic signals are issued when the motor switches to counterclockwise rotation.

8. To switch on the apex distance acoustic signals, press the *Apex distance acoustic signals* key.
  - ↳ If the key is colored orange, distance acoustic signals will be issued in addition to the distance display diagram. If the automatic motor stop is switched off, the intervals between the acoustic signals vary according to the measured distance from the physiological apex. If this function is switched on, the acoustic signals vary depending on the measured distance to the preset motor stop position. For more information on the acoustic signals during apex measurement, see the section "Acoustic signals" [→ 124].
9. Touch the *Return* key.

↳ The *Motor screen* is displayed.

### ⚠ CAUTION

#### Preventing incorrect measurements

When performing the apex measurement, wear non-conductive gloves to avoid measurement errors caused by unwanted leakage current.

During the measurement, the instrument must not come into contact with the patient's mucosa, metallic tooth restorations, or the mucosal electrode. It is recommended to pull the silicone isolation sleeve over the handpiece and perform the treatment using a cofferdam.

10. Attach the required root canal file to the handpiece.
11. Short the electrical measurement system. Plug in the files and hold them directly against the mucosal electrode. This cancels out any inaccuracies caused by jumps in impedance in the measurement setup (standardization).
  - ↳ If a short signal is heard and the distance display appears with no bars, standardization was successful. If not, check the electrical connections for signs of damage.
12. Place the mucosal electrode in the patient's mouth and perform the treatment. Activate the bur using the foot pedal.
  - ↳ The measured root canal depth is displayed by a colored bar in the distance display. For more information, please refer to "Distance display" [→ 121].

### 4.5.12 ApexLocator

The ApexLocator can be used to measure the working length of the root canal file in endodontic treatments using electrical impedance.

The ApexLocator can be used as follows:

- For manual measurement using a file clamp [→ 125]
- For measurement during treatment with the motor, without electronic torque limitation [→ 115]
- For measurement during treatment with the motor and using the "Endodontic Treatment" option with electronic torque limitation [→ 141]

With the *EasyMode Start program* operating mode, the ApexLocator can only be used for manual measurements with a file clamp.

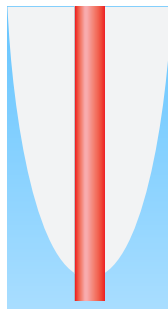

#### **⚠ CAUTION**

**The ApexLocator can be influenced by electromagnetic fields.**

This may lead to measurement errors. Strong interference is indicated by a flashing red bar in the distance display. A warning signal sounds.

- Ensure that there are no sources of electromagnetic interference close to the treatment center.

If the ApexLocator detects a defect, the distance display and apex operating keys are not shown on the touchscreen, and an error message appears in the status bar, see "Error Messages." [→ 282]

For more information about the distance display, see "Distance display." [→ 121]

### 4.5.12.1 Preparing to use the ApexLocator

#### Apex adapter, mucosal electrode and file clamp

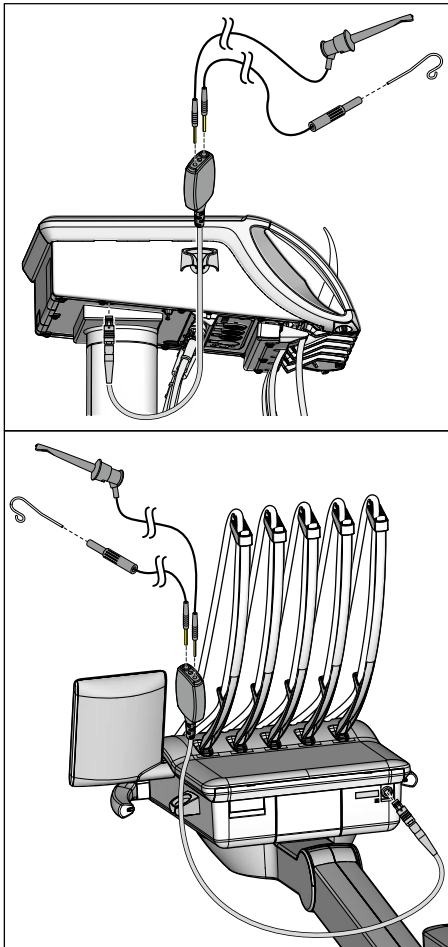

The mucosal electrode and the file clamp are connected to the socket of the dentist element using the apex adapter. The socket on the Sinius and Sinius TS dentist elements is located underneath the dentist element; on the Sinius CS it is located at the rear.

1. Insert the apex adapter at the dentist element.  
The apex adapter must be stored in the apex mounting during the treatment.
2. Insert the connector of the mucosal electrode into the large socket of the apex adapter.
3. For manual measurement: Insert the connector of the file clamp into the small socket of the apex adapter.

#### **⚠ CAUTION**

Following treatment with the ApexLocator, the Apex adapter must be disconnected from the dentist element.

If the apex adapter is placed in the holder during treatment, the file clamp and mucosal electrode must be removed or placed under sterile conditions.

Care and cleaning of the ApexLocator components is described in the chapter "Care and cleaning instructions for the practice team", see "Cleaning and disinfecting/sterilizing the components of the ApexLocator" [→ 233].

#### Apex measurement via the instrument

The apex is measured by means of an impedance measurement between the root canal file and mucosal electrode. The Apex measurement signal is as follows:

- Apex cable in the instrument hose
- Metal housing of the motor
- Metal housing of the ISO adapter, if applicable
- Endodontic handpiece
- Root canal file
- Mucosal electrode
- Apex adapter

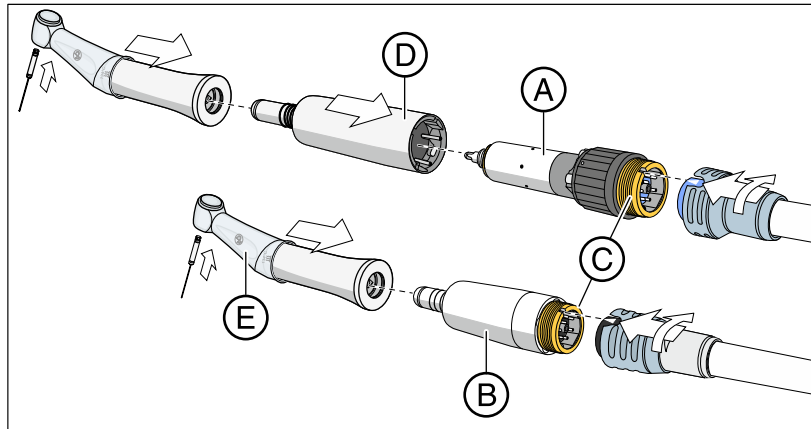

For endodontic treatments with the ApexLocator, the Dentsply Sirona Endo 6:1 (from serial number 6407 / July 2010) or Endo 6 L contra-angle handpieces are required for the treatment function. When using the ApexLocator in the motor dialog (without electronic torque limitation), the Dentsply Sirona SiroNiTi Apex contra-angle handpiece is required.

For each of the motors BL **A** and BL ISO **B**, one apex instrument hose is available, which carries the apex cable. The connecting threads of these motors **C** have gold-plated contact surfaces (in BL motors with serial number 6,000 or higher). The gold-plating ensures the electrical conductivity.

When using the BL motor, the (Apex) basic adapter **D** must be used as an intermediate piece. This is also provided with a gold contact.

The motor end of the Apex instrument hoses is identified by a blue connecting nut.

Pull the silicone insulation sleeve **E** over the contra-angle handpiece and wear insulating gloves to prevent faulty measurements due to leakage current. During the measurement, the instrument must not come into contact with the patient's mucosa or the mucosal electrode. We recommend the use of a cofferdam for treatment.

#### **⚠ WARNING**

**The silicone isolation sleeve is a single-use item and must be sterilized before use.**

Details can be found in the section "Cleaning and disinfecting/sterilizing the components of the ApexLocator" [→ 233].

#### **Standardization of the measuring system**

Before starting the apex measurement, a functional check or standardization of the measuring system can be performed by shorting the electrodes. This cancels out any inaccuracies caused by skips in impedance in the measurement setup.

- > Short the electrical measurement system. Plug in the files and hold them directly against the mucosal electrode.
  - ↳ If a short signal is heard and the distance display appears with no bars, standardization was successful. If not, check the electrical connections for signs of damage.



### 4.5.12.2 Distance display

The measured root canal depth is shown in the distance display on the touchscreen. A bar with 11 display levels shows the distance from the root canal file to the physiological apex (apical constriction). The root canal is divided into four colored sections in the distance display.

#### CAUTION

**The distance display is not a metric specification of length.**

The ApexLocator should be used as an additional aid to supplement the usual root canal treatment measures. It is not intended to replace the radiological determination of the working length.

> To determine the exact length, also prepare the relevant X-ray images.

#### Automatically show and hide the distance display

For measurement during the treatment using the instrument, the distance display is automatically displayed on the touchscreen in the *motor dialog* and in the *Advanced Endodontics Program*. This appears as soon as the measurement begins, i.e. when electric current flows between the root canal file and the mucosal electrode. After the measurement, the distance display disappears again after a certain time, so that any hidden setting values are visible again. The distance display can be displayed again by standardizing the measuring system.



For manual measurements using the file clamp in the *Start* subscreen, the distance display can be shown/hidden by pressing the *Apex measurement with file clamp* button.

#### Colored regions of the distance display

##### Gray region

The tip of the root canal file is in the middle region of the root canal.

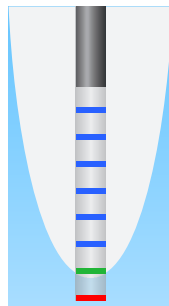

##### Blue region

The tip of the root canal file is near the apex.

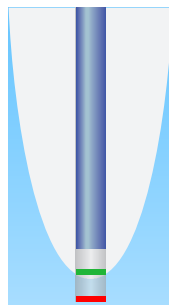

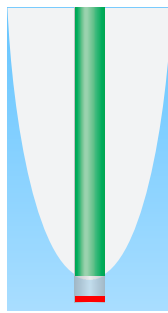

### Green region

The tip of the root canal file has reached the physiological apex.

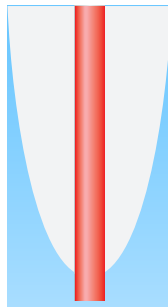

### Red region

The tip of the root canal file has pierced the physiological apex. The instrument overshoot is displayed.

In the event of electromagnetic interference, the red bar flashes.

### Maximum root canal depth reached

The maximum root canal depth reached is displayed as a black triangle to the left of the distance display under the text "Max". The triangle is displayed as soon as the gray region is exceeded.

After standardization of the measuring system by shorting the mucosal electrode and root canal file, the position of the triangle is automatically reset. In the *Endodontics dialog*, this also occurs after you have selected a new file.

### Automatic motor stop for a preset apex distance

You can make a setting to ensure that the motor stops automatically at a preset distance from the apex. The preset distance is displayed as a black triangle to the right of the distance display under the text "Stop".

The motor stop can be combined with the *AutoReverse* function. Following the motor stop, the next time the foot control is operated, the motor switches to counterclockwise rotation. When the root canal file is withdrawn, the burr drive automatically switches back to clockwise rotation.

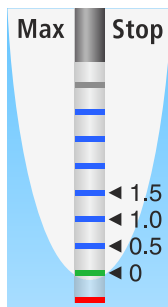

The automatic motor stop can be switched off or set to four different levels, for more information see the section "Implantology/endodontics treatments with motor" [→ 115] and the section in the "Endodontics" chapter "Setting the automatic motor stop of the ApexLocator" [→ 145]. If the distance is 0, the motor does not stop until it reaches the physiological apex. Please note that the distance values are not a metric length measurement!

### Dental unit plugin "ApexLocator distance display"

The distance display on the touchscreen can be additionally shown on the Sivation monitor. This requires that the Sidexis 4 and dental unit plugins are installed on the PC. In Sidexis 4, the distance is displayed/hidden on the touchscreen by touching the distance display.

For more details, refer to the "Dental unit plugins" user manual.

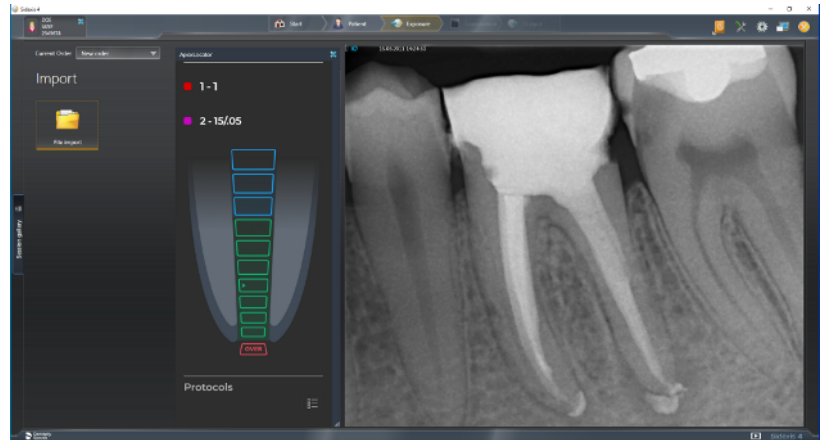

### 4.5.12.3 Beeps

In addition to the graphical distance display on the touchscreen, the position of the file in the root canal can also be indicated as an acoustic signal.

#### Apex acoustic signals

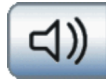

The ApexLocator always plays the following acoustic signals:

- One beep sounds when the physiological apex is reached and the motor stops automatically once it has reached the preset motor stop position.
- Three beeps sound if the motor is switched to counterclockwise rotation when the auto-reverse function is activated and the foot pedal is pressed again.

For manual measurements using the file clamp in the *Start* sub-screen, Apex signal tones are not output.

#### Apex distance acoustic signals



If the *Apex distance signal tones* key is highlighted in orange, the following signal tones are issued in addition to the Apex signal tones:

- No acoustic signal is played if the file is at least five display levels (on the distance display) away from the apex.
- Beeps with long intervals are played if the file is three or four display levels away from the apex.
- Beeps with short intervals are played if the file is one or two display levels away from the apex.
- A constant signal is played when the file has reached or passed the apex.

If both types of acoustic signal are switched on simultaneously, the continuous signal sounds when the motor automatically stops after it reaches the apex and the motor stop function is switched on. The three beeps continue to sound if auto-reverse is switched on.

#### 4.5.12.4 Performing manual measurements with the file clamp

For an endodontic examination, manual measurements can be made using the file clamp and a root canal file.

- ✓ The treatment center is prepared for manual measurements using the file clamp, see section "Preparing to use the ApexLocator" [→ 119].
- ✓ The *Start* sub-screen is displayed on the touchscreen.

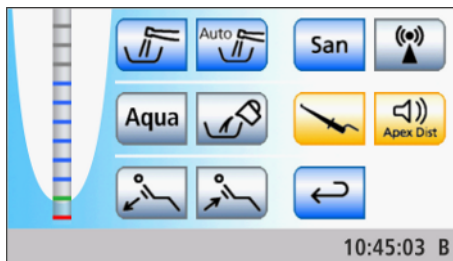

1. Touch the *Manual measurement with file clamp* key.
  - ↳ If this function is activated, the *Manual measurement with file clamp* key is highlighted in orange.
  - ↳ The distance display is shown on the touchscreen.

2. If the distance to the apex is to be indicated with an acoustic signal, press the *Apex distance signal tones* button.
  - ↳ If the button is colored orange, acoustic signals will be played in addition to the distance display diagram. The intervals between the acoustic signals vary according to the measured distance to the apex.

#### **⚠ CAUTION**

##### **Preventing incorrect measurements**

When performing the apex measurement, wear non-conductive gloves to avoid measurement errors caused by unwanted leakage current.

During the measurement, the root canal file must not come into contact with the patient's mucosa, metallic tooth restorations, or the mucosal electrode. We recommend the use of a cofferdam for treatment.

3. Attach a root canal file to the file clamp.
4. Short the electrical measurement system. Hold the clamped files directly against the mucosal electrode. This cancels out any inaccuracies caused by jumps in impedance in the measurement setup (standardization).
  - ↳ If a short signal is heard and the distance display appears with no bars, standardization was successful. If not, check the electrical connections for signs of damage.
5. Place the mucosal electrode in the patient's mouth and perform the measurement.
  - ↳ The measured root canal depth is displayed by a colored bar in the distance display. For more information, please refer to "Distance display" [→ 121].

The manual measurement in the *Start* sub-screen is ended automatically when you exit the program or display another program.

### 4.5.13 SiroSonic TL scaler

The SiroSonic TL scaler is used for removing plaque and for endodontic treatments.

#### IMPORTANT

See also the SiroSonic TL instructions for use.

#### 4.5.13.1 Safety instructions

The torque wrench is used as a tool for screwing in instrument tips and, at the same time, to protect against injury.

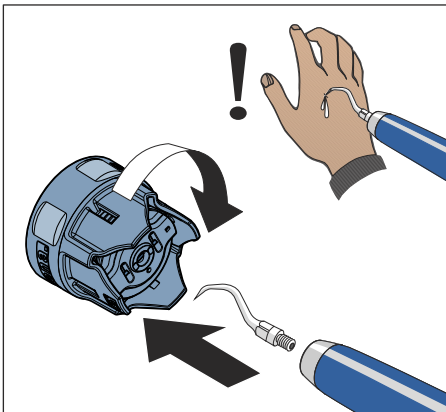

#### ⚠ CAUTION

**Ultrasonic tips are very sharp.**

There is a risk of injuring the hand when the ultrasonic handpiece is in the holder.

- Always attach the torque wrench to the ultrasonic handpiece for protection as soon as you deposit the handpiece.

#### ⚠ CAUTION

**Ultrasonic tips from other manufacturers do not guarantee safe operation and can lead to harm.**

- Use only original Dentsply Sirona parts or parts/tips approved by Dentsply Sirona. Safe operation is not guaranteed for parts/tips that have not been approved by Dentsply Sirona and the handpiece may be damaged.

#### 4.5.13.2 Setting the intensity

In the *Standard Start dialog* mode, settings can be made using the static quick setting keys (with the key values 1, 25, 50, 75, 100), with programmable quick setting keys (with changeable key values), or via function levels (E1, E2).

In the *EasyMode Start dialog*, the intensity can be set only using the static quick setting keys.

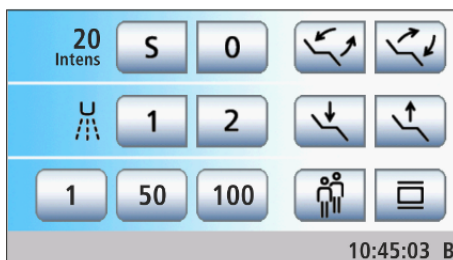
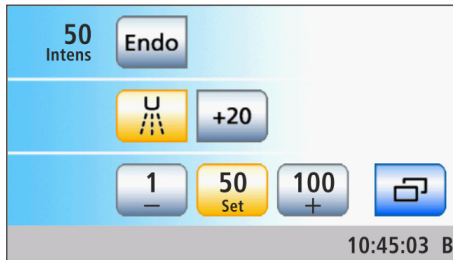
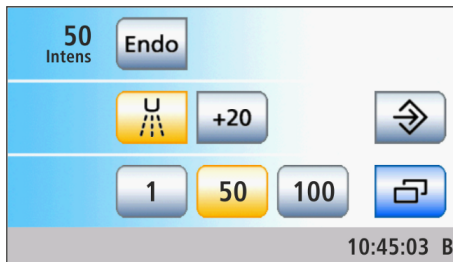

### Selecting the intensity with the quick setting keys

- ✓ The SiroSonic TL scaler is removed.
- ✓ Either the *Ultrasonic dialog* with static or programmable quick setting keys or the *EasyMode Start dialog* is displayed on the touchscreen.
- > Touch one of the quick setting keys in the bottom line briefly (<1 s).
  - ↳ The quick setting key is highlighted orange. The selected intensity is displayed in the first line.

### Setting intermediate intensity values with static quick setting keys

- ✓ The SiroSonic TL scaler is removed.
- ✓ The *Ultrasonic dialog* with static quick setting keys or the *EasyMode Start dialog* is displayed on the touchscreen.
- > Increase intensity: Hold down a quick setting key, which has an intensity value that is greater than or equal to the one displayed in the first line (> 1 s).  
Decrease intensity: Hold down a quick setting key, which has an intensity value that is lower than the one displayed in the first line (> 1 s).
  - ↳ The selected intensity is displayed in the first line. The intensity changes in increments of 1. The quick setting keys are shaded gray for intermediate values.

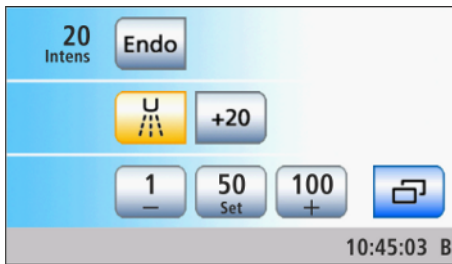

### Setting intermediate intensity values with programmable quick setting keys

- ✓ The SiroSonic TL scaler is removed.
- ✓ The *Ultrasonic dialog* with programmable quick setting keys is displayed on the touchscreen.
- Press and hold the left or right quick setting key – or + (> 1 s).
  - ↳ The intensity is increased or reduced.

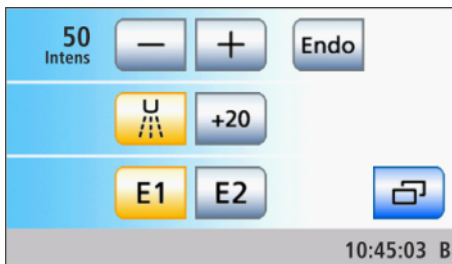

### Setting the intensity with function levels

- ✓ The SiroSonic TL scaler is removed.
- ✓ The *Ultrasonic dialog* with function levels is displayed on the touchscreen.
- Set the intensity using the – and + keys.
  - < 1 s coarse adjustment, > 1 s fine adjustment
  - ↳ The selected intensity is displayed in the first line.

### IMPORTANT

#### Increments

The coarse adjustment increments are 1, 25, 50, 75, 100.  
For fine adjustment, the intensity changes in increments of 1.

### Increasing the intensity by increments of 20 (boost function)

The boost function allows for a 20-step increase of the intensity during treatment in relation to the final value. From an intensity of 80, the maximum value of 100 is the maximum that can be selected.

In the *EasyMode Start dialog* operating mode, this function can only be set by using the right key of the foot control. Activation of the boost function is only seen on the user interface if the intensity is increased on the display. The +20 key is not available.

- ✓ The SiroSonic TL scaler is removed.
- ✓ The *Ultrasonic dialog* is displayed on the touchscreen either with static or programmable quick setting keys or with function levels.

1. Touch the +20 key on the touchscreen.

or

- Press the right button of the foot control.

↳ The key is highlighted orange. The Boost function is activated.

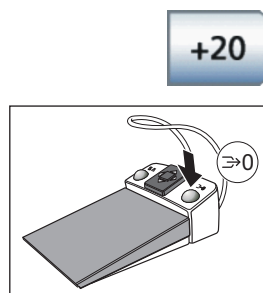



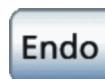
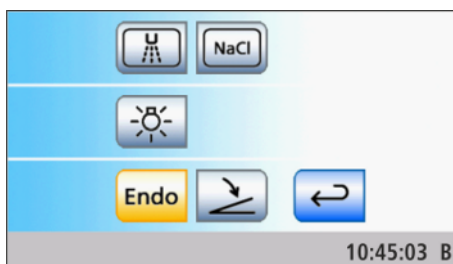
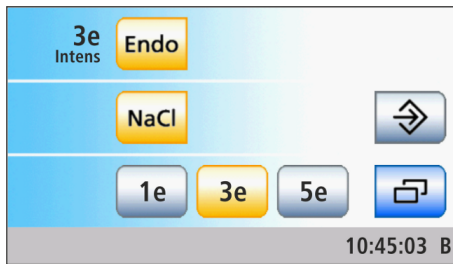

### Switching on the endodontics function

The intensity of the endodontics function is limited for safety reasons, e.g., in order to prevent broken needles.

If the instrument programs are displayed in the *Standard Start dialog* operating mode with static quick setting keys, they are assigned values 1e to 5e when the endodontics function is activated. With the programmable quick setting keys, the values 1e to 5e can be saved to the keys.

In the *EasyMode Start dialog* operating mode, the endodontics function must be switched on using the sub-dialog.

#### IMPORTANT

##### Endo intensity values

The intensity can be adjusted from 1e to 5e. Please note that the endodontics intensity values of 1e to 5e do not match the values of 1 to 5 in the scaler mode.

Always use the Endo mode for endodontics!

- ✓ The SiroSonic TL scaler is removed.
- ✓ The *Ultrasonic dialog* or *Standard Start dialog* is displayed on the touchscreen.

1. Only in the *EasyMode Start dialog* operating mode: Press the *Instrument* program change key.

↳ The *Ultrasonic* sub-dialog is displayed.

2. Touch the *Endo* key.

↳ The key is highlighted orange. In the first row of the ultrasonic dialog, the endodontics intensity is displayed instead of the ultrasonic intensity.

### 4.5.14 Implantology and endodontic treatment

The treatment functions support implantology and endodontic treatments. The speed and torque of the rotating instrument can be precisely adjusted and saved for later reference, if desired. This is possible for every work step for implantology treatments. A selection of the most popular file systems with the speed and torque values recommended by the manufacturer is provided for endodontic treatments in a library. The file composition and sequence can be set by the user. If the treatment center is equipped with the ApexLocator option, this can be used for endodontic treatments. The treatment center enables the management of two implantology treatments and up to three endodontic treatments with individual settings for each user profile.

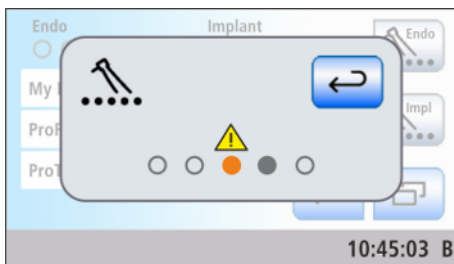

If the adjacent display appears when the treatment function is switched on (see below), the software has detected that the bur drive marked with a warning triangle is not suitable for treatment purposes. In this case, please contact your dental depot.

The Treatment function can only be accessed in the *Standard Start program* operating mode.

### 4.5.14.1 Treatment selection

#### Switching the function on and selecting the treatment

In the *Treatment selection* program, the treatment types Endodontics and Implantology are specified in two separate lists. The required treatment is selected from these lists.



#### IMPORTANT

##### Pencil symbol

Endodontic treatments that were created or edited by the user are marked with a pencil symbol. Please note that changes to the file settings may have been made during these treatment sessions. E.g., files were possibly removed from the sequence or the values recommended by the manufacturer were altered.

✓ The *Start dialog* is displayed on the touchscreen.

1. Touch the *Treatment* key.



↪ The *Treatment selection* screen is displayed.

2. Touch the field for the desired endodontic (left) or implantology (right) treatment.

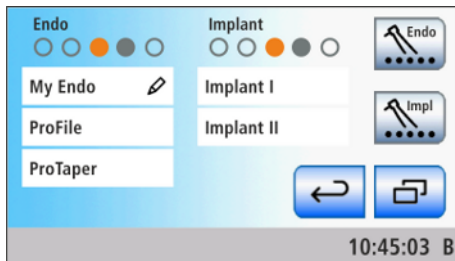

↪ The *Start dialog* is displayed or, if an instrument has already been taken from the holder, the system will switch to the *Instrument dialog*. The *Treatment* key is marked orange. The bur drive that corresponds to the treatment is displayed in the status bar with an orange dot. Please refer to the section "Assigning bur drives" for information on the significance of the empty or filled dots.

3. Take the burr drive from the instrument holder which is marked with an orange dot in the status bar.

↪ Depending on the type of treatment selected, the *Endodontics* program or the *Implantology* program is displayed on the touchscreen.

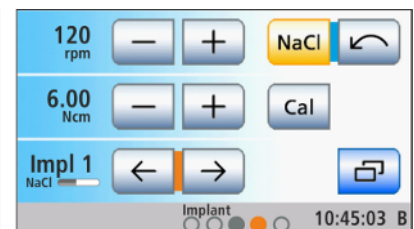
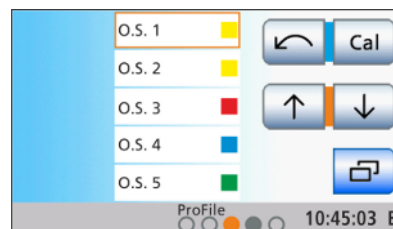
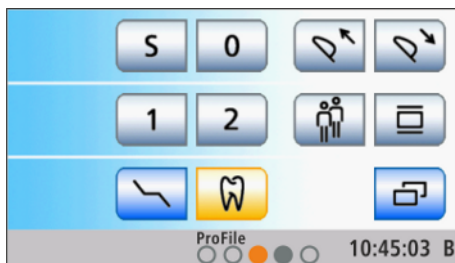

*Endodontics dialog (left) and implantology dialog (right)*

## IMPORTANT

### Display of the blue and orange cursor

In the *Implantology* and *Endodontics* treatment programs, the key assignment of the foot control is indicated by blue and orange cursor bars even when cursor control is switched off. The orange cursor can only be moved with the 4-way foot switch plate when cursor control is switched on. For more information on the cursor control, please refer to "Using the cursor control" [→ 60].

### Assigning the bur drive

A specific bur drive must be assigned to each treatment type, i.e. endodontics and implantology.



The *Treatment Selection* screen indicates which bur drive is assigned to the treatment type and which one could be used alternatively:

- Empty, gray circle  
Instrument cannot be used for the selected treatment type
- Solid gray circle  
Bur drive can be assigned to the selected treatment type
- Solid orange circle  
Bur drive is assigned to the selected treatment type

If you would like to use a different bur drive for the treatment, you can change this setting:

- ✓ The *Treatment selection* program is displayed on the touchscreen.
- > Before selecting the treatment, touch the upper or lower *Assign bur drive* key.
  - Upper key: endodontic treatment
  - Lower key: implantology treatment
- ↪ The next usable bur drive is marked by the orange dot. The required bur drive is assigned to endodontics or implantology treatment.



### Switching the treatment function off

When the treatment function is activated, the *Implantology dialog* or the *Endodontics dialog* is displayed on the touchscreen instead of the *Motor dialog* when the bur drive assigned to the selected treatment is removed from its holder. In order for the *Motor dialog* to be displayed again the next time the bur drive is removed, the treatment function must be switched off beforehand.

- > Touch the *Treatment* key again.
  - ↪ If the key is blue, the Treatment function is deactivated. The *Motor dialog* is activated when a bur drive is removed from its holder.



#### 4.5.14.2 Implantology

##### CAUTION

**Only the Dentsply Sirona contra-angle handpiece Implant 20:1 may be used for the Implantology function.**

Instruments from other manufacturers can lead to malfunctions. Third-party instruments may be improperly calibrated for implantology.

- > Use only the Dentsply Sirona Implant 20:1 contra-angle handpiece from Sirona for implantology.
- > Check whether the transmission ratio on the touchscreen agrees with the value specified on the contra-angle handpiece being used.

##### 4.5.14.2.1 Calibrating the burr drive

Calibration is required at the start of treatment, every time the contra-angle handpiece is changed and every time the contra-angle handpiece is lubricated.

The contra-angle handpiece is automatically checked during calibration. This includes a measurement of motor current at different speeds to assess the properties of the system.

##### CAUTION

To ensure proper calibration, use only Dentsply Sirona instruments.

- ✓ The *Implantology dialog* is displayed on the touchscreen.
- 1. Attach the contra-angle handpiece that you would like to use for the implantology treatment to the electric motor.
- 2. Insert the tool in the contra-angle handpiece. This is thus also taken into account by the measurement.
- 3. Touch the *Cal*key on the touchscreen.
  - ↳ The button flashes orange.
- 4. Hold down the foot pedal throughout the duration of the calibration.
  - ↳ The *Cal*key continues to flash. If the burr drive is calibrated, the key permanently remains highlighted orange. Calibration is then completed.



##### 4.5.14.2.2 Setting the speed and torque

In the Implantology function, the speed and torque values of the contra-angle handpiece, and not those of the motor, are specified. The control electronics of the burr drive calculate the motor control based on the specified gear reduction and the speed and torque values.

- ✓ The *Implantology dialog* is displayed on the touchscreen.
- > Use the – and + keys to set the speed and torque of the contra-angle handpiece. You can also press and hold the keys to do this.
  - ↳ The selected speed is displayed in the first line in rpm (revolutions per minute). The torque is displayed in the second line in Ncm (Newton centimeters).



### IMPORTANT

#### Torque adjustment

The maximum adjustable torque depends on the system motor and the speed settings.

### CAUTION

#### Improperly selected speeds and torque values endanger the patient.

Treatment errors, e.g. jaw damage, may result from incorrect settings.

- > Observe the manufacturer's instructions regarding tools and implants.

#### 4.5.14.2.3 Setting the direction of rotation

The direction of rotation can only be changed when the motor is idle.

Counterclockwise rotation is performed without torque limitation. The torque setting keys are hidden when counterclockwise rotation is selected.

- ✓ The *Implantology dialog* is displayed on the touchscreen.



1. Touch the *Counterclockwise rotation* key on the touchscreen.

or

- > Press the right button of the foot switch.

- ✎ For counterclockwise rotation: The key *Counterclockwise rotation* is highlighted orange and an orange counterclockwise rotation arrow appears.

For clockwise rotation: The key *Counterclockwise rotation* is displayed in gray and the orange counterclockwise arrow is hidden.

**Tip:** After starting the electric motor with the foot switch, an audible warning signal sounds 6 times if counterclockwise rotation is activated.

#### 4.5.14.2.4 Activating/deactivating and setting the NaCl flow

In order to supply the burr drive with a sterile saline solution during implantology treatments, a peristaltic pump must be attached to the dentist element; see "Preparing for use of (NaCl) saline solution" [→ 96].

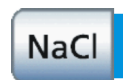

The peristaltic pump can be switched on/off by touching the *NaCl* key. If the key is highlighted orange, the pump is activated using the foot control.



The NaCl flow rate set of the peristaltic pump is permanently displayed by a bar in the bottom line of the touchscreen in the *Implantology* program.

The flow rate can be set by pressing and holding the *NaCl* key (> 2 seconds). For details, see "Setting the NaCl flow rate" [→ 98].

#### 4.5.14.2.5 Selecting a work step

Individual settings can be made and saved for each implantology work step, e.g. predrilling, final drilling, tapping, etc., see "Saving settings" [→ 137]. At the end of each work step, the required settings can be accessed immediately by selecting the next step.

- ✓ The *Implantology dialog* is displayed on the touchscreen.
- > Select the required implantology work step. Touch the *previous step* or *next step* key.
  - ✎ The selected work step is displayed on the touchscreen. The settings saved in the work step are preset.



If NaCl rinsing was selected in the *Implantology* sub-dialog, the *CCW rotation* key is displayed instead of the *previous step* key. The implantology steps can then be run only forward in a loop. See "Preselecting NaCl rinsing, setting the flow rate, and activating the rinse function" [→ 136].

#### 4.5.14.2.6 Functions in the sub-screen

##### Opening the implantology sub-screen

- ✓ The *Implantology dialog* is displayed on the touchscreen.

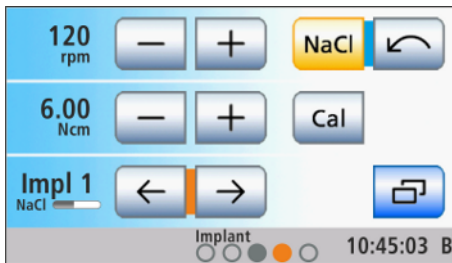

- > Touch the *Sub-dialog* key.

- ✦ The *Implantology* sub-dialog is displayed.



##### Preselecting NaCl rinsing, setting the flow rate, and activating the rinse function

The NaCl rinsing function can be used to activate an NaCl jet to rinse the treatment area when the bur instrument is not running.

##### Preselecting the NaCl rinsing key

A setting can be made to show or hide the *NaCl rinsing* key in the *Implantology Program*. If the show function is selected, the *NaCl*, *NaCl Rinsing* and *CCW Rotation* keys are all displayed adjacent to one other. The implantology steps can then be run only forward in a loop.

- ✓ The *Implantology* sub-dialog is displayed on the touchscreen.

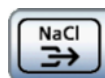

- > Touch the *Preselect NaCl rinsing* key.

- ✦ If the key is highlighted orange, the NaCl rinsing keys are shown in the sub-dialog and the *NaCl rinsing* is displayed in the *Implantology dialog*.

##### Setting the flow rate for NaCl rinsing

The flow rate of the peristaltic pump for NaCl rinsing can be set separately.

- ✓ The *Preselect NaCl rinsing* key is marked orange in the sub-dialog. The setting keys for the NaCl rinsing are now displayed.

- > Use the – and + keys to set the flow rate for NaCl rinsing.





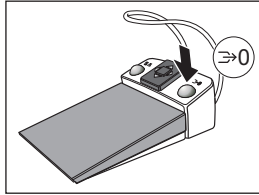

### Activating NaCl rinsing via button on foot control

- ✓ The *NaCl rinsing* key is displayed in the *Implantology dialog*.
- > Press the right button of the foot switch.
  - ↳ The NaCl rinsing function remains active as long as the button is pressed.

### Switching the torque signal on/off

This can be used to set the acoustic signal that sounds whenever 75% of the currently set torque value is exceeded.



- > Touch the *Acoustic Signal* key.
  - ↳ If the key is highlighted orange, the torque acoustic signal is activated.

### Saving settings

The following settings can be saved for the selected work step in the *Implantology dialog*:

- Speed and torque [→ 133]
- NaCl cooling and NaCl cooling quantity [→ 134]

In addition, the system will save the following settings that apply to the entire treatment:

- Presetting of NaCl rinsing and NaCl rinsing quantity [→ 136]
- Torque signal [→ 137]

### IMPORTANT

The system will always save the entire treatment, including the step-independent settings of the treatment and the specific settings of all treatment steps, not just those of the current work step.



- ✓ The corresponding settings are made.
- ✓ The *Implantology dialog* is displayed.
- > Press and hold the *Memory* key (> 2 s).
  - ↳ An acoustic signal sounds. The settings you have made will be saved for every work step and the entire treatment session.

#### 4.5.14.2.7 Preparing the treatment center for sterile operation

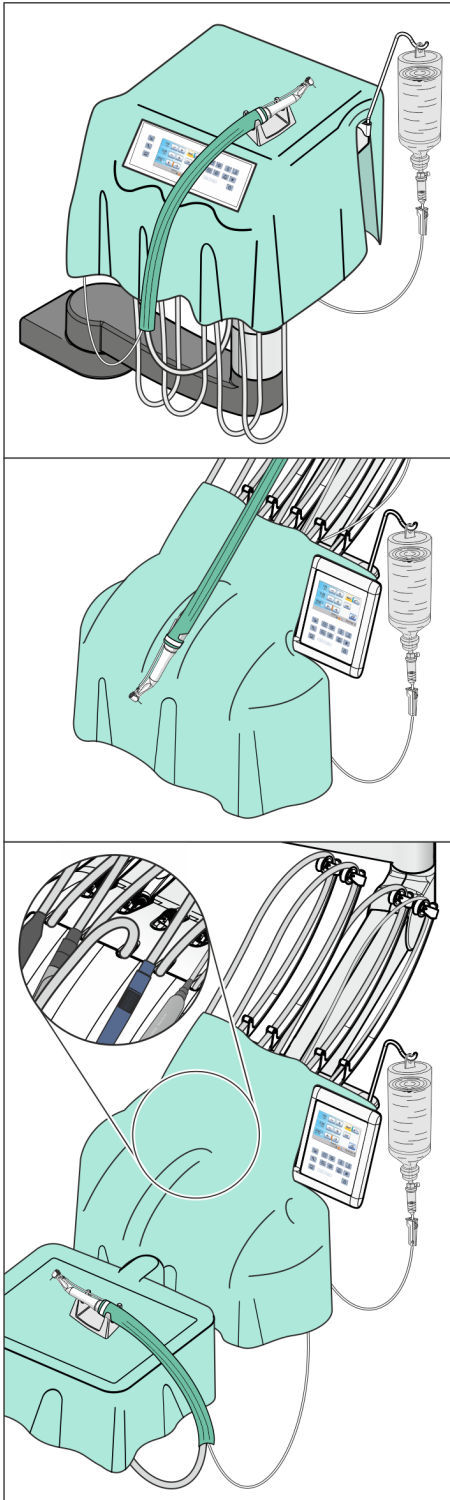

The requirements for sterile operation must be met for surgical procedures. Work only with the cursor control to avoid touching the user interface.

##### Covering the dentist element with a sterile drape

The dentist element and tray can be covered with a surgical drape to allow for sterile operation.

For the **Sinius with sliding track and Sinius TS** a rectangle must be cut out of the drape to allow for operation and visibility of the EasyTouch.

In order to connect the BL Implant motor hose on the **Sinius CS**, the instrument holder must be removed before covering with a sterile drape. To do this, remove all instruments one after the other and allow them to hang down in front of the dentist element. Lift the instrument holder by the front edge until the clamps are released and the holder can be removed.

On the **Sinius CS** without a tray, the BL Implant motor hose must be threaded through the swivel arm. The motor is then positioned on the instrument holder that is covered with a sterile drape.

If the **Sinius CS** dentist element is equipped with a tray, we recommend removing the standard motor with the swivel arm. Let the BL Implant motor hose hang down in front of or next to the dentist element. Position the motor on the tray in the separate motor holder (see below). When using this method, be sure to activate the implantology treatment function before detaching the swivel arm. To do this, touch the *Treatment* key in the start dialog. Then take the burr drive assigned to implant treatment (orange dot). As long as the treatment function is not switched off, you can alternate between the implant treatment and the start dialog.

##### Use of separate motor holder

When the instrument holder of the dentist element is inaccessible due to the surgical drape, the burr drive being used can be deposited in a separate motor holder. This holder is set on the dentist element or the instrument holder.

The motor holder can be sterilized.

To reorder the motor holder, see "Spare parts and consumables" [→ 285].

##### Attaching the instrument hose cover

The instrument hoses cannot be sterilized. Therefore, the instrument hose of the burr drive used must be covered with a sterile paper sleeve. The instrument hose sleeves can be ordered from a specialist dealer.

### 4.5.14.3 Endodontics

#### ⚠ CAUTION

For the endodontics function, only Dentsply Sirona Endo 6:1 (SN 6407 and above / July 2010) and Endo 6 L contra-angle handpieces may be used.

Instruments from other manufacturers can lead to malfunctions. Third-party instruments may be improperly calibrated for endodontics.

- > For endodontics, use Dentsply Sirona Endo 6:1 (SN 6407 and above / July 2010) or Endo 6 L contra-angle handpieces.
- > Check whether the transmission ratio on the touchscreen agrees with the value specified on the contra-angle handpiece being used.

#### 4.5.14.3.1 File selection

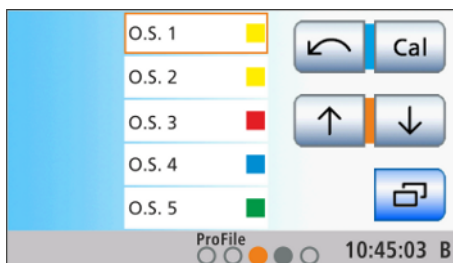

A list of the files available for this endodontic treatment is displayed over the full height of the touchscreen in the *Endodontics dialog*. This allows five files to be displayed at the same time.

The speed and torque values preset or set for the selected files are automatically used.

#### ⚠ CAUTION

The parameters of the filing systems can be changed by the respective manufacturer. Therefore, please make sure to always check the specifications of the respective manufacturer prior to use.

- ✓ An endodontic treatment is selected.
  - ✓ The *Endodontics dialog* is displayed on the touchscreen.
1. Use the ↑ and ↓ keys to select the file that you would like to use.  
or
  - > Select the endo file directly by touching the corresponding list entry.  
    ↳ The selected file is highlighted orange.

**Tip:** The four keys that are marked with cursor positions (blue/orange) can be operated with the foot switch even when the cursor control is not activated.

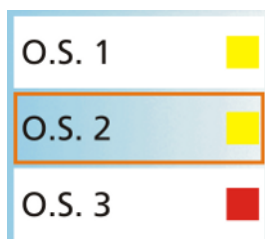

#### IMPORTANT

##### Background shading of files

Files are displayed on the touchscreen with or without a white background. Files, for which the speed or the torque were changed, are highlighted with a transparent background.

#### ⚠ CAUTION

##### Root canal files are subject to material fatigue

Fatigued files may break during treatment.

- > Use files only for the service life specified by the manufacturer.

 **CAUTION**

The parameters of the filing systems can be changed by the respective manufacturer. Therefore, please make sure to always check the specifications of the respective manufacturer prior to use.

#### 4.5.14.3.2 Calibrating the burr drive

Calibration is required at the start of treatment, every time the contra-angle handpiece is changed, and every time the contra-angle handpiece is lubricated. Recalibration is not necessary when a file is changed. Calibrating the motor" />

The contra-angle handpiece is automatically checked during calibration. This includes a measurement of motor current at different speeds to assess the properties of the system.

 **CAUTION**

To ensure proper calibration, use only Dentsply Sirona instruments.

- ✓ The *Endodontics dialog* is displayed on the touchscreen.
- 1. Attach the contra-angle handpiece that you would like to use for the treatment to the electric motor.
- 2. Insert a file in the contra-angle handpiece. This ensures that the file is taken into account in the measurement.
- 3. Touch the *Ca*key on the touchscreen.  
or  
> Press the right button of the foot control.
  - ↳ The button flashes orange.
- 4. Hold down the foot control throughout the duration of the calibration.
  - ↳ The *Ca*key continues to flash. During calibration, increasing speeds are set on the motor. If the burr drive is calibrated, the key permanently remains highlighted orange. Calibration is then completed.



#### 4.5.14.3.3 Setting the direction of rotation

The direction of rotation can be changed only with the motor stopped.

Counterclockwise rotation is performed without torque limitation. The torque setting keys are hidden when counterclockwise rotation is selected.

- ✓ The *Endodontics dialog* is displayed on the touchscreen.
- 1. Touch the *CCW Rotation* key on the touchscreen.  
or  
> Press the left button of the foot control.
  - ↳ For counterclockwise rotation: The *CCW Rotation* key is highlighted orange and an orange CCW arrow appears.  
For clockwise rotation: The *CCW Rotation* key is displayed gray and the orange CCW arrow disappears.



After you start the electric motor with the foot control, an audible warning signal sounds 6 times if counterclockwise rotation is activated.

#### 4.5.14.3.4 Using reciprocal rotating files

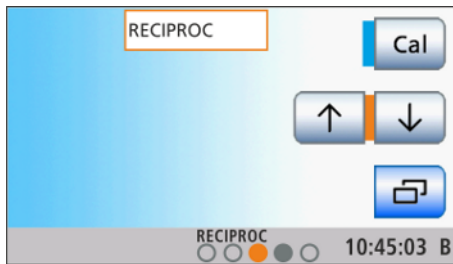

For endodontic treatment with reciprocating rotating files, the sequence of the files and the preset values recommended by the manufacturer cannot be changed.

The keys for setting the speed and torque and the counterclockwise key are hidden.

If the treatment center is equipped with the ApexLocator option, it can also be used with reciprocating rotating files.

#### 4.5.14.3.5 Using the ApexLocator

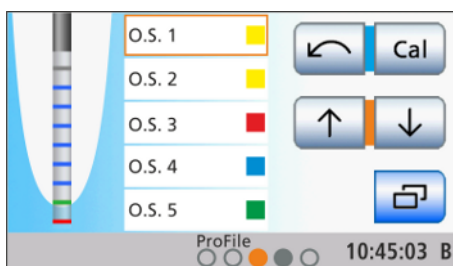

- ✓ The treatment center is prepared for apex measurements using the instrument, see section "Preparing to use the ApexLocator" [→ 119].
  - ✓ The *Endodontics dialog* is displayed on the touchscreen.
1. Select a file, see "Selecting a file" [→ 139]. If necessary, change the preset speed and torque, see "Setting the speed and torque" [→ 143].
  2. You can set the motor so that it stops automatically when the physiological apex is reached. If you want to use the automatic motor stop, this can be preset in the *Endodontics* sub-dialog. The automatic motor stop can be combined with the *Auto-Reverse* function, see "Switching the automatic motor stop of the ApexLocator on/off" [→ 145].

### IMPORTANT

#### Preventing incorrect measurements

When performing the apex measurement, wear non-conductive gloves to avoid measurement errors caused by unwanted leakage current.

During the measurement, the instrument must not come into contact with the patient's mucosa, metallic tooth restorations, or the mucosal electrode. It is recommended to pull the silicone isolation sleeve over the handpiece and perform the treatment using a cofferdam.

3. Attach the previously selected file to the handpiece.
4. Short the electrical measurement system. Plug in the files and hold them directly against the mucosal electrode. This cancels out any inaccuracies caused by jumps in impedance in the measurement setup (standardization).
  - ↳ If a short signal is heard and the distance display appears with no bars, standardization was successful. If not, check the electrical connections for signs of damage.
5. Place the mucosal electrode in the patient's mouth and perform the treatment. Activate the bur using the foot pedal.
  - ↳ The measured root canal depth is displayed by a colored bar in the distance display. For more information, please refer to "Distance display" [→ 121].

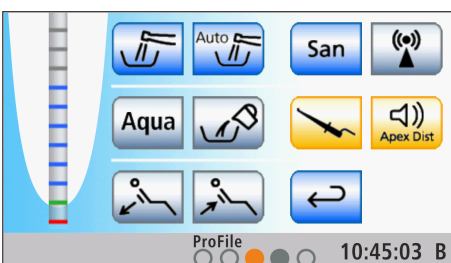
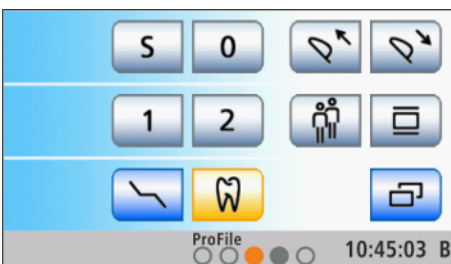
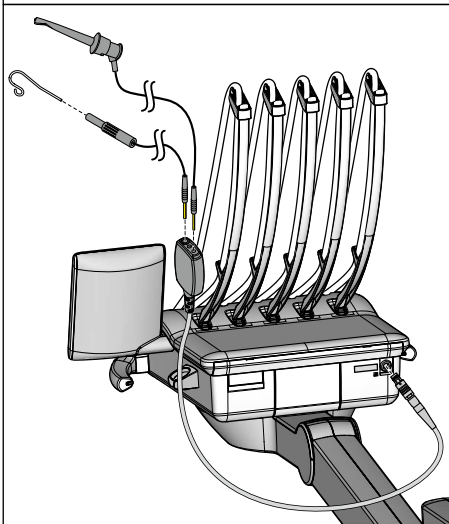
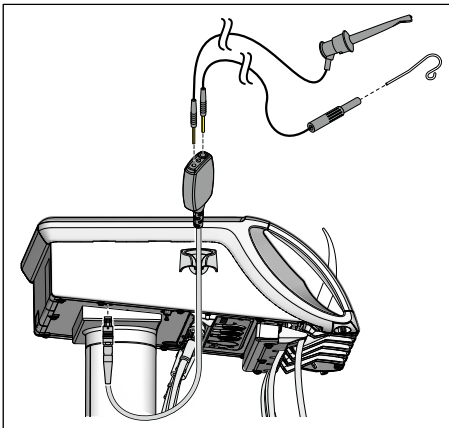

For manual measurement using the file clamp, you can change directly from the *Endodontics* dialog to the *Start* sub-dialog.

✓ Endodontics treatment is activated.

1. Return the endo handpiece to the instrument holder.

↪ The *Start* dialog is displayed with the treatment function activated.

2. Conduct a manual measurement using the file clamp.

↪ When a signal is detected via the file clamp, the *Start* sub-dialog appears automatically with manual measurement activated. The function cannot be switched off.

3. Remove the endo handpiece from the holder again.

↪ The display switches back to the *Endodontics* dialog. Apex measurement is again done via the handpiece.

#### 4.5.14.3.6 Functions in the sub-screens

##### Opening the endodontics sub-screen

Settings, such as changing the preselected speed and torque values [→ 143], or removing a file from the sequence [→ 146], are file-specific. They apply only to the file selected from the file list. Therefore please double-check which file is selected from the list before opening the *Endodontics* sub-dialog.

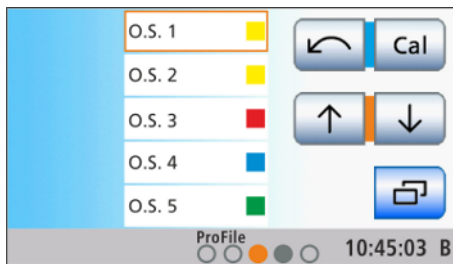

✓ The *Endodontics dialog* is displayed on the touchscreen.

1. Use the ↑ and ↓ keys to select the file whose settings you would like to change.
  - ↪ The selected file is highlighted orange.



2. Touch the *Sub-dialog* key.

↪ The *Endodontics* sub-dialog is displayed.

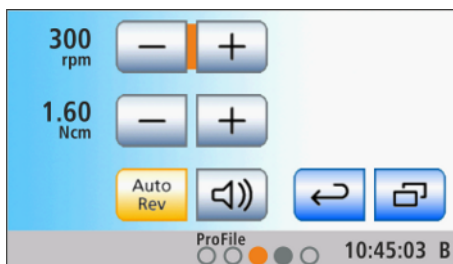

3. Touch the *sub-dialog* key again to activate the second sub-dialog.

↪ The second *Endodontics* sub-dialog is displayed.

- > Perform the settings as described in the following sections:



##### Setting the speed and torque

If you do not wish to work with the standard parameters of the file, you can set them yourself.

In the Treatment function, the speed and torque values of the contra-angle handpiece, and not those of the motor, are specified. The control electronics of the burr drive calculate the motor control based on the contra-angle handpiece gear reduction and the speed and torque settings.

1. Select a file from the file list of the *Endodontics dialog* to change its speed and torque values. Touch the ↑ and ↓ keys.
  - or
  - > Touch the file in the file list.

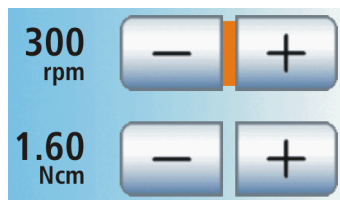

- ☞ The selected file is highlighted orange.
- 2. Switch to the *Endodontics* sub-dialog and use the – and + keys to set the speed and torque of the contra-angle handpiece. You can also hold down the keys for this purpose.
  - ☞ The selected speed is displayed in the first line in rpm (revolutions per minute); the second line indicates the speed in Ncm (NewtonCentimeters).

### IMPORTANT

#### Torque adjustment

The maximum adjustable torque depends on the system motor and the speed settings.

### ⚠ CAUTION

#### Improperly selected speeds and torque values endanger the patient.

Treatment errors, e.g. breaking of a file, may result from incorrect settings.

- > Observe the manufacturer's instructions regarding file systems.

### ⚠ CAUTION

#### For the endodontics function, only Dentsply Sirona Endo 6:1 (SN 6407 and above / July 2010) and Endo 6 L contra-angle handpieces may be used.

Instruments from other manufacturers can lead to malfunctions. Third-party instruments may be improperly calibrated for endodontics.

- > For endodontics, use Dentsply Sirona Endo 6:1 (SN 6407 and above / July 2010) or Endo 6 L contra-angle handpieces.
- > Check whether the transmission ratio on the touchscreen agrees with the value specified on the contra-angle handpiece being used.

### Switching AutoReverse ON/OFF

A setting can be made so that the bur drive automatically switches to counterclockwise rotation when the preset torque value is reached.

If your treatment center is equipped with the ApexLocator option, you can set the bur drive to stop automatically at a preset distance from the apex, see "Switching the automatic motor stop of the ApexLocator on/off" [→ 145]. If the AutoReverse function is switched on, the next time the foot pedal is activated following a motor stop, the motor is switched to counterclockwise rotation. When the file is withdrawn, the bur drive automatically switches back to clockwise rotation.

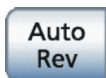

- > Touch the *AutoRev* key.
  - ☞ If the key is highlighted orange, the AutoReverse function is activated.



### Turning on/off the automatic motor stop of the ApexLocator

If your treatment center is equipped with the ApexLocator option, you can set the motor to stop at the physiological apex. The motor stop can be combined with the *AutoReverse* function, see "Switching the *AutoReverse* function on/off" [→ 144].

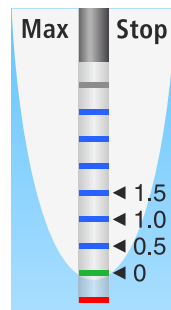

1. Touch the *Apex stop* key.
  - ↳ If the key is highlighted orange, the automatic motor stop is activated.
2. Use the – and + keys to set the required apex distance from 1.5 to 0. If the distance is 0, the motor does not stop until it reaches the physiological apex. Please note that the distance values are not a metric length measurement!
  - ↳ The set distance is displayed to the left of the – and + keys. The preset motor stop position is displayed in the *Endodontics dialog* as a black triangle to the right of the distance display below the text "Stop".

Apex settings are stored automatically when the treatment is completed.

### Switching the torque signal and apex signal tones on/off

This can be used to set the acoustic signal that sounds whenever 75% of the currently set torque value is exceeded.

If your treatment center is equipped with the ApexLocator option, this button also switches the apex signal tones on or off. A beep is emitted when the apex or a set motor stop position is reached. If the *AutoReverse* function is activated, three acoustic signals are emitted when the motor switches to counterclockwise rotation. For more information on the acoustic signals during apex measurement, see the section "Acoustic signals" [→ 124].



- > Press the *Torque signal and apex acoustic signals* key.
  - ↳ If the key is marked in orange, the torque signal and the apex acoustic signals are switched on.

### Switching the apex distance signal tones on/off

If your treatment center is equipped with the ApexLocator option, you can adjust a setting so that distance signal tones are emitted in addition to the graphical distance display. If the automatic motor stop is switched off, the intervals between the acoustic signals vary according to the measured distance from the physiological apex. If this function is switched on, the acoustic signals vary depending on the measured distance to the preset motor stop position. For more information on the acoustic signals during apex measurement, see the section "Acoustic signals" [→ 124].



- > Press the *Apex distance acoustic signals* key.
  - ↳ If the key is highlighted orange, the apex distance acoustic signal is activated.

## Remove file from sequence

Individual files can be removed from the sequence.

### IMPORTANT

#### Automatic file system reset

When the treatment function is completed, the files removed from the file system are inserted again and changed speed and torque values are reset according to recommendations of the file manufacturers.

Only treatments created by the user retain changes to file systems after the treatment function is exited, provided that the changes were saved previously. See "Copying existing endodontic treatment" [→ 147]. User-created treatments are marked with a pencil symbol in the *Treatment selection* dialog.

The ApexLocator settings, the auto-reverse function and the acoustic signals are always saved automatically when the treatment function is exited.

1. Select a file from the file list of the *Endodontics dialog* to remove it from the sequence. Touch the ↑ and ↓ keys.

or

- > Touch the file in the file list.

- ↳ The selected position is highlighted orange.

2. Switch to the *Endodontics* sub-dialog and touch the *Delete* key > 2 s.

- ↳ The selected file is removed from the sequence.



#### Switch instrument light on/off

The Dentsply Sirona Endo 6L handpiece is equipped with a light guide.

- > Switch the instrument light on or off with the *Instrument light* key.

- ↳ If the key is highlighted orange, the instrument light can be activated using the foot pedal.



#### Speed foot control

The use of the speed foot control is not available in the *Endodontics dialog*!



#### 4.5.14.3.7 Endodontic treatment administration

Up to three endodontic treatments can be added to the treatment list of the *Treatment selection* screen. The following functions are for managing the endodontic treatment list:

- Copying, renaming and, if necessary, deleting endodontic treatments
- Adding specified file systems to the endodontic treatment list

Endodontic treatments using rotating files cannot be changed.

##### Opening the endodontic management program

✓ The *Start dialog* is displayed on the touchscreen.

1. Touch the *Treatment* key.



↳ The *Treatment selection* dialog is displayed.

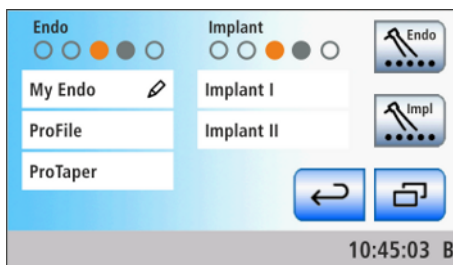

2. Before selecting a treatment, touch the *Endodontic management* key.

↳ The *Endodontic management* dialog is displayed.



##### Copying an existing endodontic treatment

A treatment can be copied and saved in the treatment list under a different name. Then the settings can be changed.

This procedure allows for making changes to factory-preset endodontic treatments (without a pencil symbol).

The treatment center enables you to create up to three endodontic treatments. After the third treatment has been added, the *Copy endodontic treatment* key disappears.

1. Touch the button of an endodontic treatment that you would like to copy.

↳ The selected button is highlighted orange.

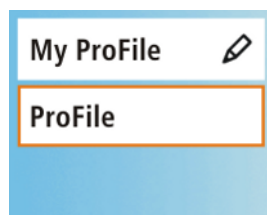

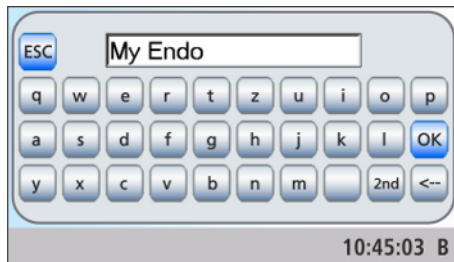

2. Touch the *Copy endodontic treatment* key.
  - ↳ A keyboard is displayed. The name of the endodontic treatment to be copied is displayed in the text box.
3. Enter the name of the copy. Confirm your entry with the *OK* key.
  - ↳ The keyboard is hidden. The new endodontic treatment is displayed in the treatment list with the designation you entered.

### Rename endodontic treatment

When copying endodontic treatments, the user must name them accordingly. They also can be renamed later on to facilitate corrections and editing.

#### IMPORTANT

Factory specified endodontic treatments cannot be renamed. If an endodontic treatment without a pencil symbol is selected, the *Rename endodontic treatment* key is hidden.

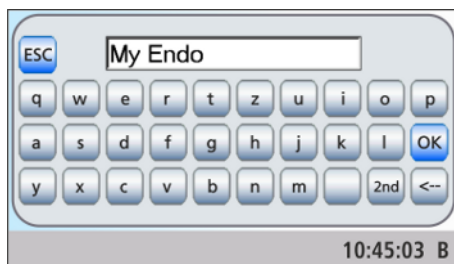
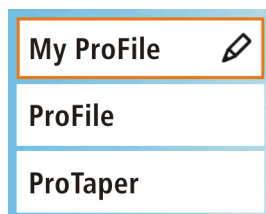

1. Touch the button of an endodontic treatment that you would like to rename.
  - ↳ The selected button is highlighted orange.
2. Touch the *Rename endodontic treatment* key.
  - ↳ A keyboard is displayed.
3. Rename the endodontic treatment. Confirm your entry with the *OK* key.
  - ↳ The keyboard is hidden. The designation of the endodontic treatment is changed in the treatment list.

### Deleting an endodontic treatment from the list

If user-created endodontic treatments are no longer required or must be replaced, they can be deleted from the treatment list. Endodontic treatments that were preset by factory default can only be removed by deselecting the corresponding file system, see "Adding a file system to the treatment list" [→ 149].

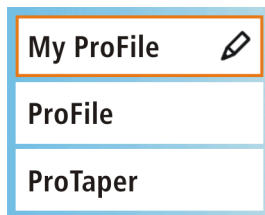

1. Touch the button of an endodontic treatment that you would like to delete.  
 ↳ The selected button is highlighted orange.

2. Touch the *Delete endodontic treatment* key for more than 2 seconds.  
 ↳ The selected endodontic treatment is deleted. It is no longer displayed in the treatment list.

### Adding a file system to the treatment list

The treatment center software contains the most popular endodontic file systems with the speed and torque values recommended by the manufacturer in a library. The required file systems can be added to the endodontic treatment list via a pick list.



1. Touch the *Add file system* key.  
 ↳ A list of the most popular file systems is displayed.

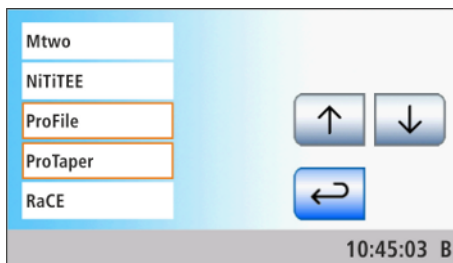

2. Select the file system that you would like to add to the endodontic treatment list. You can scroll in the list with the ↑ and ↓ keys. Touch the button of the desired file system (multiple file systems can also be selected).  
 ↳ The selected buttons are highlighted orange.



3. Touch the *Return* key.  
 ↳ The *Treatment administration* screen is displayed. The selected file systems are displayed in the endodontic treatment list of the *Treatment selection* screen.

The treatment center enables you to add up to three endodontic treatments to the treatment list. When the third endodontic treatment is selected, a symbol appears on the touchscreen. This symbol indicates that the maximum number (total number of self-created and in the library selected treatments) has been reached.

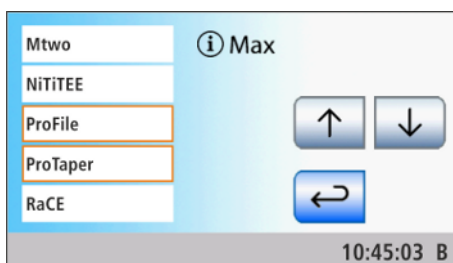

### IMPORTANT

#### Expanding a file system via a software update

File systems previously added to the treatment list are not automatically adjusted during a software update. As a consequence, new files are not immediately displayed in the file list.

- Deselect and then immediately re-activate the file system concerned.
- ↳ After you select endodontic treatment, the added files are displayed in the file list.

## 4.6 Assistant element

### 4.6.1 Maximum load capacity

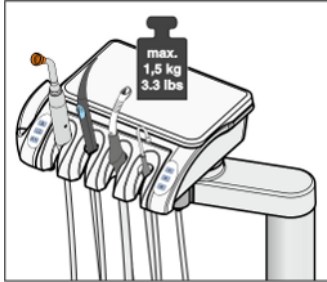

The maximum load of the assistant element is 1.5 kg (3.3 lbs). A skid-proof silicone mat can also be used.

#### **⚠ CAUTION**

To prevent injuries caused by falling objects, never place anything on the support arm of the assistant element.

### 4.6.2 Positioning

#### **⚠ CAUTION**

**The assistant element can be positioned above or below the patient chair.**

The patient could be pinched during chair movements or the chair could be damaged.

- Move the assistant element out of the collision zone before moving the patient chair.

#### **IMPORTANT**

##### **Safety stop**

In case of collision, a safety system in the support arm stops the chair movement.

### 4.6.3 Fixed keys on the assistant element

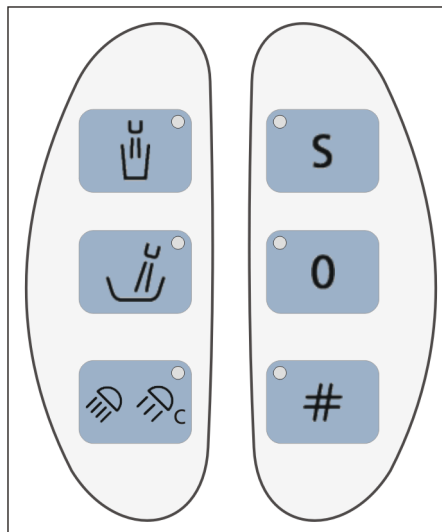

The functions assigned to the keys can be switched on/off on the assistant element. The settings screens can be opened only on the touchscreen of the dentist element. To make settings, see "Fixed keys on the dentist element" [→ 81].

#### 4.6.3.1 Tumbler filling

If the your treatment center is equipped with the Tumbler filling option with automatic sensor control, see "Tumbler filling with automatic sensor control" [→ 160].

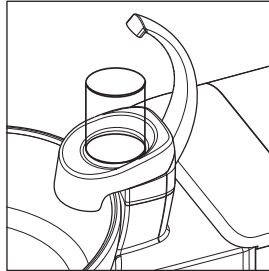

1. Place the tumbler under the tumbler filler.

2. Press the *Tumbler Filling* fixed key.

↳ The tumbler is filled with water for the preset time. The LED in the key lights up during the tumbler filling process.

Pressing the *Tumbler Filling* fixed key again stops the filling function immediately.

#### 4.6.3.2 Flushing of the cuspidor bowl

The flushing function can be used for rough cleaning of the cuspidor during treatment.



> Press the *Cuspidor flushing* fixed key.

↳ The cuspidor flushing will be switched on for the pre-set flushing time. The LED for the key lights up during the flushing process.

#### 4.6.3.3 Operating light

Repeatedly press the fixed key *Operating light* to set the following switching positions at the assistant element:

1. Switched on: The operating light is switched on at the preset brightness level.
2. Composite function: This function delays the curing of composite materials.
3. Switched off



> Press the *Operating light* fixed key, repeat if necessary.

↳ The operating light switches to "switched on", "composite function" or "switched off". When the operating light is in use, the LED on the fixed key lights up on the dentist and assistant elements.

#### 4.6.3.4 Chair programs S and 0

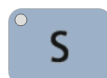

The chair programs Mouth rinsing position (S) and Entry/exit position (0) can be selected on the assistant element:

For details, see "Moving the patient chair via chair programs".



Mouth rinsing position and Entry/exit position programs can also be programmed from the assistant element side, see "Programming chair programs and shock positioning" [→ 75].

#### 4.6.3.5 Hash key

The *Hash key* on the assistant element can be configured in the setup dialog. The key allows the user to switch the X-ray viewer or the white screen function on the Sivation monitor on or off or alternatively to activate the bell or hash relay, see "Setting function of the Hash key on assistant element" [→ 196].

The white screen function can be used if the treatment center has no X-ray viewer, but is equipped with a Sivation monitor, see "Show/hide key for white screen on Sivation monitor." [→ 196]



> Press the *Hash key*.

↳ If the *hash key* is set to control the X-ray viewer or the bell or hash relay, the LED of the key lights up when the function is activated.

If the white screen function is controlled in Sivation monitor using the *hash key*, the LED of the *hash key* does not light up. It is lit only when the X-ray viewer is switched on. In addition, the *White screen* key is no longer shown in orange in the *Start dialog*.



#### 4.6.4 Suction handpieces

The assistant element can be equipped with a maximum of three suction handpieces.

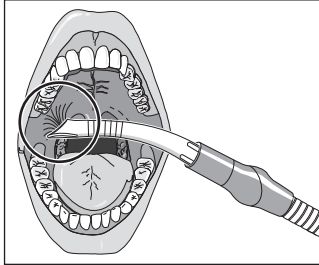

#### **⚠ CAUTION**

**The tip attaches itself to the oral mucosa.**

The patient's oral mucosa can be irritated by the vacuum.

- Make sure that you hold the suction tip in such a way that the opening cannot accidentally attach to the oral mucosa. Dentsply Sirona recommends using spray aspirator cannulas with additional air intake, see "Spare parts, Consumables" [→ 285].

#### **⚠ CAUTION**

**The spray aspirator can be switched off with the 4-way foot switch.**

Due to the lack of suction flow, fluid may run back out of the spray aspirator and into the patient's mouth.

- It must be ensured that there is a suction flow before holding the spray aspirator in the mouth.
- Always remove the spray aspirator from the patient's mouth before switching it off.

#### **NOTE**

**Suction removal of metal oxides from blasting devices**

Observe the safety information on the "Vacuum system" [→ 16].

**Tip:** The factory-set suction power can be adjusted in the water unit by a service technician.

#### **Spray aspirator**

The suction handpiece can be angulated by turning it.

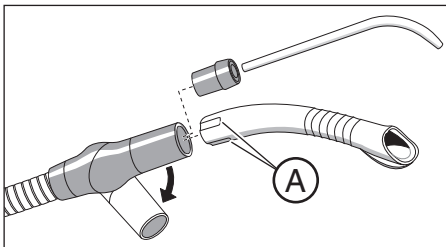

To prevent completely interrupting the suction flow when the tips attach to the oral mucosa, spray aspirator tips with lateral air intakes **A** should be used. This prevents backflow from the hose into the oral cavity if the tip attaches itself.

The thick suction hose can be used for surgical suction. To attach a surgical tip, please use the adapter supplied.

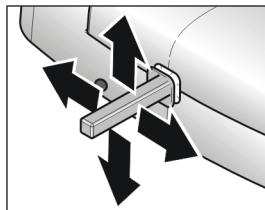

Settings can be made so that the suction flow of the spray aspirator can be interrupted or reactivated by pressing the 4-way foot switch at the base of the chair in any direction; see "Linking the spray aspirator to the 4-way foot switch" [→ 195].

#### **Saliva ejector**

A curved tip that can be placed in the corner of the mouth is provided for saliva ejection.

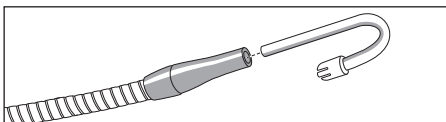

### Surgical suction

The surgical tip can be inserted directly into the saliva ejector handpiece.

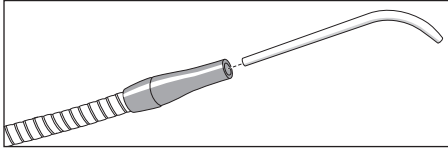

#### 4.6.5 Multifunctional syringe Sprayvit M

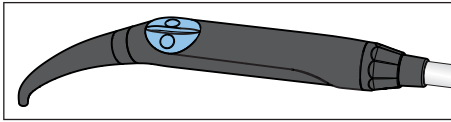

The functionality is described in the section on the dentist element, see "Sprayvit M multifunctional syringe" [-> 99].

### 4.6.6 Mini LED curing light

The curing light is used to cure composite material with short-wave light.

#### IMPORTANT

Observe the operating instructions Mini L.E.D. of the Satelec Acteon manufacturer.

#### 4.6.6.1 Safety instructions

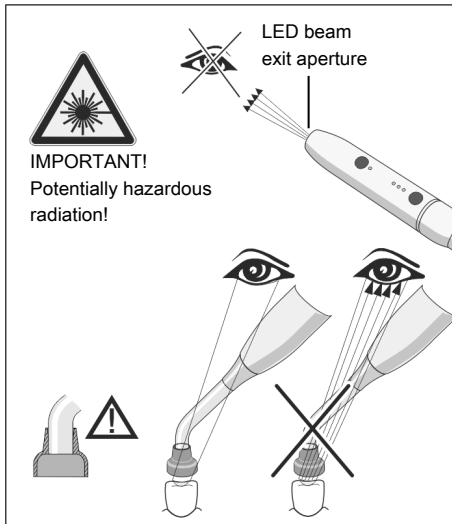

#### CAUTION

The curing light contains powerful LEDs. In accordance with IEC 62471, they are classified in risk group 2 with the light bar removed.

- Do not stare into the beam path for longer periods, as this can damage your eyes.
- Do not observe the light aperture with optical instruments which can decrease the beam cross-section (e.g. magnifying lenses).
- Do not under any circumstances stare into the beam path when the glass rod is removed.
- Never aim the laser beam at the user's or the patient's eyes, even if he or she is wearing protective goggles.
- Never work without the glare shield.
- Never look into the light reflected by the tooth surface.
- Aim the light only at the treatment area in the oral cavity.

Any condensation forming in the handpiece of the Mini L.E.D. may cause impairment (e.g. fogging of the LED). When moving the handpiece from a cool environment to a warm room, always wait for it to reach room temperature before using it.

Curing lights must not be used on persons who are suffering from or have in the past been afflicted by photobiological reactions (including solar urticaria and erythropoetic porphyria). Nor should they be used on persons currently being treated with any medications which increase one's sensitivity to light (including methoxsalene and chlorotetracycline).

Persons who had diseases of the retina or lens in the past or have had eye surgery, especially for cataracts, must consult their ophthalmologist prior to treatment with the Mini L.E.D. Even if the patient consents, caution is required because the light intensity can cause accidents.

It is especially advisable to always wear appropriate protective goggles. For the frequency range of the light, refer to "Technical data" [-> 159].

#### 4.6.6.2 Symbols on the mini LED

These symbols are on the Mini L.E.D. They have the following meanings:

Follow the instructions for use



Wear eye protection



#### 4.6.6.3 Connecting the Mini L.E.D.

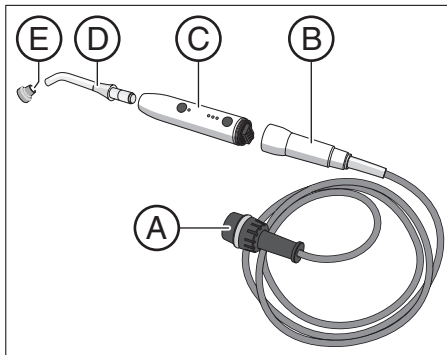

The Mini L.E.D. is connected to the assistant element in holder 1.

1. Connect the supply cable **A** to the treatment center.
2. Screw hose coupling **B** onto the Mini L.E.D. **C**.
3. Screw the sterilized light guide **D** onto the Mini L.E.D. **C**. Make sure to insert the fiber optic correctly.
  - ↳ The fiber optic clicks into place audibly.
4. Slip the glare shield **E** onto the light guide **D**.
  - ↳ The glare shield protects your eyes against reflecting curing light.

#### 4.6.6.4 Functional description

##### Operational Elements

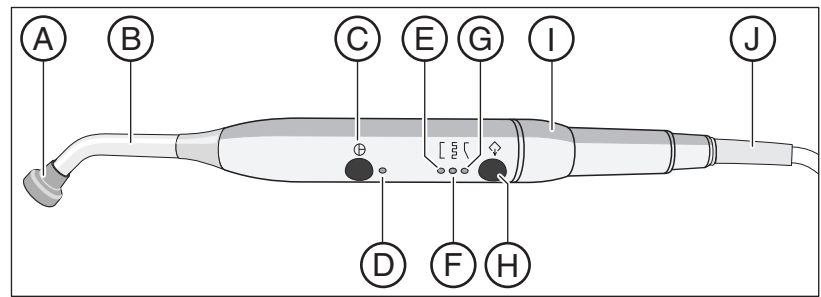

A	Glare shield	F	Pulse curing mode light
B	Fiber	G	"Soft start" mode lamp
C	On/off button	H	Mode button
D	Status control lamp	I	Handpiece
E	Quick curing mode light	J	Supply cable

##### Status control lamp

The status control lamp **D** signals the following states:

Status control lamp	Mode
OFF	Instrument in holder
Green	Normal mode
Red flashing	Overheat protection

The Mini L.E.D. has three operating modes, which you can select with the *Mode H* key:

### Quick curing mode

In the quick curing mode, the Mini L.E.D. operates at full power for 10 seconds.

In this mode, the light intensity output is as follows:

- 1250 mW/cm<sup>2</sup> (± 10%) with the standard light guide, dia. 7.5 mm
- 2000 mW/cm<sup>2</sup> (± 10%) with the booster light guide, dia. 5.5 mm

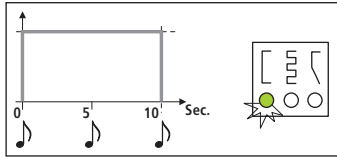

### Pulsed curing mode

In the pulsed curing mode, the Mini L.E.D. radiates in 10 consecutive light pulses of 1 s each. There is a 250 ms break between the individual pulses.

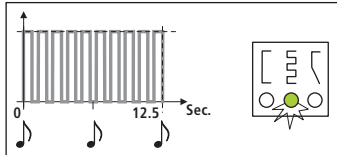

### "Soft start" mode

The "soft start" mode features:

- A 10-second "soft start" from 0 to 1250 mW/cm<sup>2</sup>, or from 0 to 2000 mW/cm<sup>2</sup> with the "booster light guide," dia. 5.5 mm.
- Full power for 10 seconds.

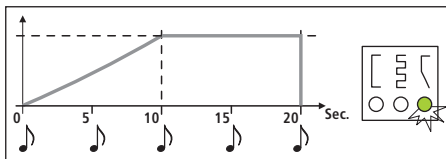

#### 4.6.6.5 Operating the Mini LED

#### IMPORTANT

##### Contact with the material to be cured

Make sure that the light guide never touches the material to be cured, as this may cause damage to the light guide and reduce its effectiveness.

When the Mini L.E.D. is removed from its holder, the operating mode last used before it was deposited is selected.

1. Use the *Mode* key **H** to select the quick curing, pulse curing or "soft start" mode.

↳ The corresponding lamp shows which mode is selected. The Mini L.E.D. is ready for operation.

2. Hold the light guide as close as possible to the composite material surface you want to photopolymerize.

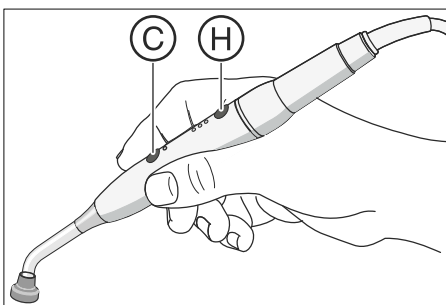

3. Start the curing cycle. Press the on/off button **C** briefly.

↳ An acoustic signal sounds. The curing cycle is started.

↳ The acoustic signal sounds every 5 seconds.

↳ The end of the curing cycle is also indicated by an audible signal.

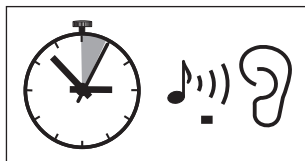

You can interrupt the curing cycle immediately by pressing the on/off button **C**.

For care and cleaning, see "Disinfecting and sterilizing the Mini L.E.D. curing light" [→ 234].

#### 4.6.6.6 Technical data

##### General Technical Data on Mini L.E.D.

Model:	Mini L.E.D.
Weight of handpiece without hose:	105 g
Dimensions:	Dia. 23mm x 240mm
Current consumption of handpiece:	5 V DC / 0.65 A
Thermal safety:	Overheat protection

##### Optical specification of Mini L.E.D.

Wavelength: Max. intensity:	420 nm – 480 nm <sup>1</sup> at 450 nm
Light power dia. 7.5 mm (standard version):	1250 mW/cm <sup>2</sup>
Light power dia. 5.5 mm (available from Satelec):	2000 mW/cm <sup>2</sup>
Light power:	450 mW – 500 mW
Classification acc. to IEC 62471	Risk group 2 with light bar removed

<sup>1</sup> Only composite materials can be cured which react to the stated wavelength. The Mini L.E.D. is not suitable, e.g. for Lucirin® (absorption maximum 380 nm).

##### Hazard distance (HD) and exposure hazard value (EHV) according to IEC 62471

	HD	EHV
Blue light Free group	907 mm	20.6
Blue light Risk group 1	323 mm	2.6
Blue light Risk group 2	–	0.01
Thermal hazard to the cornea Free group	–	0.97

## 4.7 Water unit

### 4.7.1 Swiveling the cuspidor bowl

The cuspidor on the water unit can be manually swiveled approx. 110 mm toward the patient chair.

#### IMPORTANT

##### Chair movements with cuspidor swiveled in

With the cuspidor bowl swiveled in, the chair cannot be moved. This prevents the patient from colliding with the cuspidor. Swing the cuspidor outward before initiating chair movement.

### 4.7.2 Tumbler filling with automatic sensor control

The automatic sensor control is not available in all countries.

With this tumbler filler, the sensor control automatically detects the filling level of the tumbler.

If the tumbler is removed before the preset filling level has been reached, the water flow stops immediately.

#### Filling the tumbler

- ✓ The tumbler must not be transparent.
- ✓ The tumbler must always be placed in the center of the area provided for it.
- Place the tumbler under the tumbler filler.
- ↻ The tumbler is filled automatically.
- ↻ After the preset filling level has been reached, the water flow stops automatically.

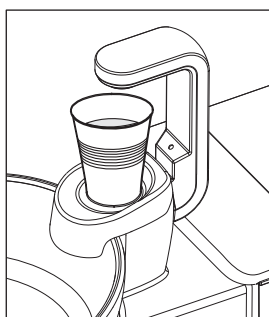

If required, the tumbler can be refilled manually by the *Tumbler filling* key; see "Setting the tumbler filling function" [→ 83].

#### IMPORTANT

##### Tumbler filling after switch-on

If an empty tumbler is standing below the tumbler filler when the treatment center is switched on, the tumbler will not be filled automatically. To activate automatic tumbler filling, remove the tumbler briefly and then put it back again.

#### Setting the filling level

The tumbler filling level can be preset.

1. Open the maintenance flap **A** on the base of the water unit.
2. Set the filling level with control knob **B**.

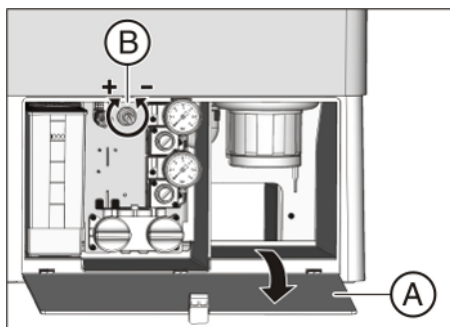



### 4.7.3 Adjusting the water amount for flushing

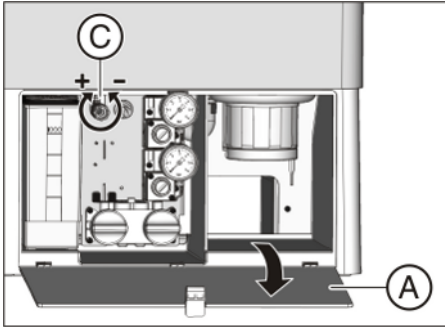

The water quantity and water pressure for flushing can be set using a throttle.

1. Open the maintenance flap (A) on the base of the water unit.
2. Adjust the water quantity with the control knob (C).

#### 4.7.4 Self-sufficient water supply

If the water quality of the public drinking water supply is not suitable for treating patients, the treatment center can be operated with a self-sufficient water supply.

In this case, food-grade water is mixed with the disinfectant for the water paths in a 100:1 ratio (1 liter of water, 10 ml of the disinfectant) and filled into the fresh water bottle or disinfectant tank of the water unit. The disinfectant reduces microbial growth in the water paths.

The self-sufficient water supply should be a temporary operating condition only if public drinking water supply is contaminated, not a permanent operating condition.

The cuspidor is still flushed using the public drinking water supply.

The self-sufficient water supply function is available only if the treatment center is equipped with an integrated water disinfection system.

#### CAUTION

##### **Microorganisms can multiply in the water.**

These microorganisms could increase the risk of damage to one's health.

- > Dentsply Sirona recommends never operating the treatment center without the agent for disinfecting the water paths.
- > Mix fresh water for the self-sufficient water supply every day. At the end of the work day, the remaining water must be flushed out of the disinfectant tank using the tumbler filling function.
- > Check the bacteria count in the water of the treatment center at regular intervals. In particular if no disinfection system is available or no disinfectant can be used for disinfecting the water paths. See "Microbiological water test" [→ 204].

#### CAUTION

##### **If self-sufficient water supply lasts more than 28 days in exceptional cases, the treatment center must be manually sanitized.**

Please follow the sanitization procedure for operation with self-sufficient water supply described in the section "Sanitizing the treatment center manually" [→ 272].

Ensure that the "*Days to next sanitization*" display does **not** appear on the touchscreen status bar when operating with a self-sufficient water supply.

#### NOTE

Always fill food-grade distilled water (< 100 colony forming units/ml), never drinking water, e.g. from beverage bottles, due to the minerals it contains.

Aqua purificata or aqua destillata can be used as distilled water.

The desired mode of operation is set using the touchscreen.

### Opening Start sub-dialog

- ✓ The *Start dialog* is displayed on the touchscreen.
- > In the *Standard Start dialog*: Touch the *Sub-dialog* key.  
In the *EasyMode Start dialog*: Press the *Chair* program change key.



- ↪ The *Start* sub-dialog is displayed.

### Changing disinfection system to self-sufficient water supply

If the *Aqua* key is displayed gray in the *Start* sub-dialog, the treatment center uses water from the public drinking water supply. If the key is highlighted orange, the treatment center is switched to self-sufficient water supply. To change the mode of operation, proceed as follows:

1. Press and hold the *Aqua* key (> 2 s).



- ↪ The *Aqua* key flashes orange until the disinfectant tank is emptied. In addition, the *Switching to self-sufficient water supply* display appears.

- ↪ If there is still agent for disinfecting the water paths in the tank, it is rinsed down the drain. This can take up to 6 minutes. The *Refill water* display then appears on the touchscreen.

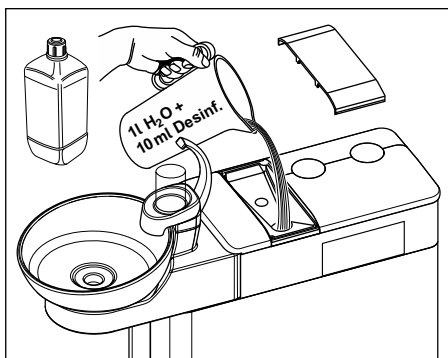

2. Mix distilled water with the agent for disinfecting the water paths at a ratio of 100:1 (1 liter of water, 10 ml of the disinfectant) and fill this into the disinfectant tank of the water unit. The tank has a capacity of approx. 1.3 liters. It is full when the water surface is visible on the filter of the filling funnel.



- In the *Start* sub-dialog, the *Aqua* key is highlighted in orange. The disinfection system is now changed to the self-sufficient water supply.

If the treatment center is changed to self-sufficient water supply, the *Sanitization* key is hidden in the *Start* sub-dialog. Without disinfectant for the water paths, it is not possible to sanitize the water paths interactively. The treatment center must be sanitized manually, see "Sanitizing the treatment center manually" [→ 272].

### Resetting the disinfection system to the public drinking water supply and the disinfectant for the water paths

Resetting the disinfection system to public drinking water is performed in the same manner as changing to self-sufficient water supply. Instead of the *Refill water* display, the *Refill disinfectant for the water paths* display appears on the touchscreen.

- Sanitize the water paths after switching to the public drinking water supply, see "Interactive sanitization of the treatment center" [→ 264].

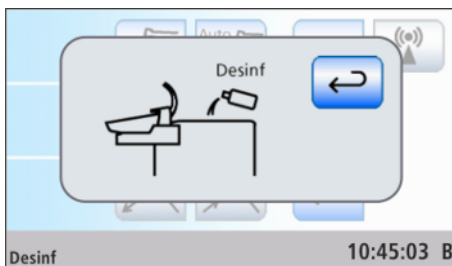

### Level control

If the *Refill water* or *Refill disinfectant for the water paths* display appears during the treatment, the reservoir is almost empty (< 400 ml). By pressing the *Return* key, the display can be hidden and the treatment can be continued. Refill the tank as soon as possible.

#### IMPORTANT

400 ml are approximately sufficient for:

- 6.5 min. spray operation (motor, high-speed handpiece, scaler) or
- 2.5 min. Sprayvit Moperation or
- 5 x tumbler fillings

The actual values depend on the instrument types and settings used.

## 4.8 Tray

### 4.8.1 Tray on the support arm (for Sinus)

#### Maximum load capacity

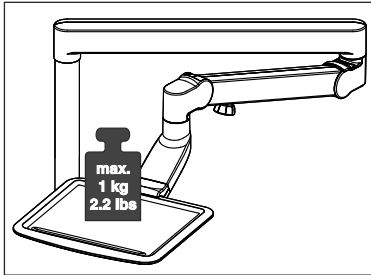

Sinus treatment centers as a sliding track device can be equipped with a tray on a support arm.

The maximum load of the tray is 1 kg (2.2 lbs).

#### Removing the tray

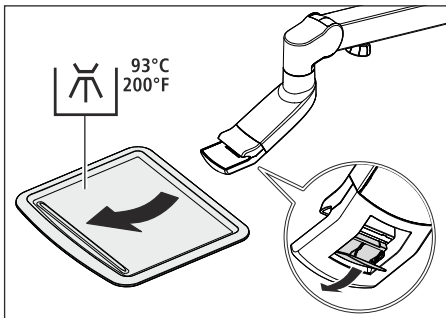

1. Hold the tray tightly.
2. Open the lock by swiveling the lever downwards.
3. Remove the tray.
4. Let the lever fall back into its original position.

To insert the tray, simply guide it into the mount. The mechanism locks automatically.

#### **⚠ CAUTION**

**If the tray is not locked in place, it can disengage from the tray holder.**

- After installing the tray, make sure it is securely attached to the tray holder.

#### Adjusting the height of the tray

The tray is supported to rotate on a height-adjustable support arm.

#### **NOTE**

**A locking brake blocks the height adjustment.**

The support arm may be damaged if you adjust the height with the locking brake applied.

- Never, under any circumstances, try to adjust the support arm with the locking brake securely tightened. Release the locking brake first.

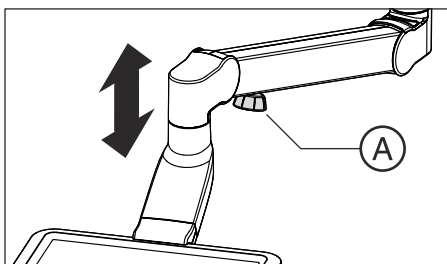

1. Loosen the brake knob **A** slightly.
2. Set the tray to the desired position.
3. Retighten the brake knob slightly.
  - ↪ The tray can thus be subjected to different loads within limits without lowering its position.

### Removing the brake knob

The brake knob of the support arm can be removed if it is found to be disturbing.

1. Loosen the brake knob at the safety screw **A**.
2. Remove the brake knob **B**.

To reattach it, insert the hexagonal pin of the brake knob **B** in the connector on the support arm. Tighten the safety screw **A**.

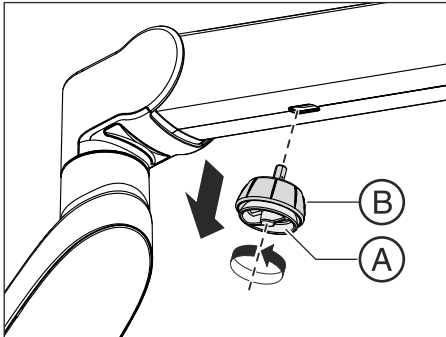

### 4.8.2 Tray on the Sinus CS dentist element

#### Maximum load capacity

Sinus CS treatment centers can be equipped with a tray that is mounted underneath the dentist element. The tray is available in two sizes for one or two standard trays.

The maximum load of the tray is 1 kg (2.2 lbs).

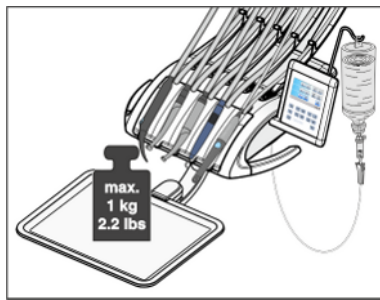

#### Removing the tray

1. Hold the tray tightly.
2. Open the lock by turning the lever downwards.
3. Remove the tray.
4. Let the lever fall back into its original position.

To insert the tray, simply guide it into the mount. The mechanism engages automatically.

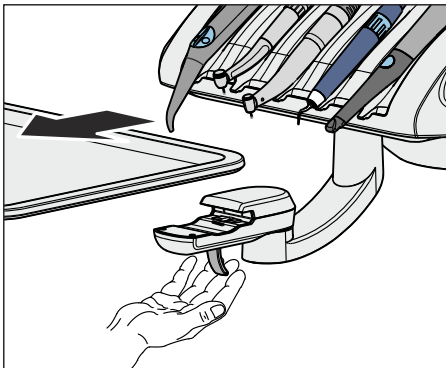

#### **⚠ CAUTION**

**If the tray is not locked in place, it can disengage from the tray holder.**

- After installing the tray, make sure it is securely attached to the tray holder.

### 4.8.3 Tray on the Sinus TS dentist element

#### Maximum load capacity

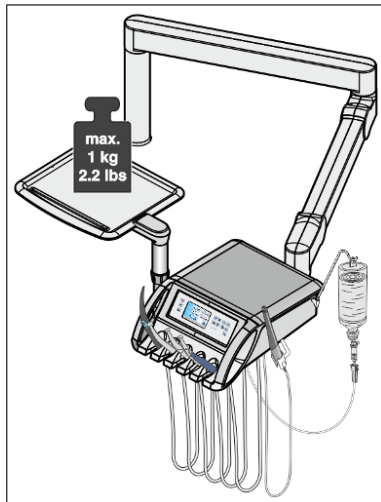

Sinus TS treatment centers can be equipped with a tray mounted to the left of the dentist element.

The maximum load of the tray is 1 kg (2.2 lbs).

With the Sinus TS, the total maximum load on the tray and dentist element should not exceed 2 kg (4.4 lb). See "Maximum load capacity of the dentist element." [→ 77]

#### Removing the tray

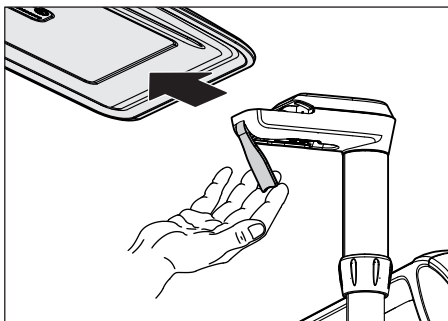

1. Hold the tray tightly.
2. Open the lock by swiveling the lever downwards.
3. Remove the tray.
4. Let the lever fall back into its original position.

To insert the tray, simply guide it into the mount. The mechanism locks automatically.

#### **⚠ CAUTION**

**If the tray is not locked in place, it can disengage from the tray holder.**

- After installing the tray, make sure it is securely attached to the tray holder.

#### Adjusting the height of the tray

The tray is attached to a height-adjustable telescope mount and can be rotated.

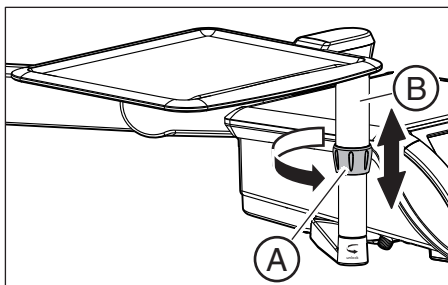

1. Turn the locknut **A** in a counterclockwise direction (right-hand groove).
  - ↳ The telescopic tube **B** is extended to the maximum length with a pneumatic spring.
2. Press the telescopic tube **B** together to the desired height and tighten the locknut **A** in a clockwise direction.

### Adjusting the stiffness of the rotary joint

In the head of the tray holder there is a regulating screw for setting the necessary exertion for turning the tray.

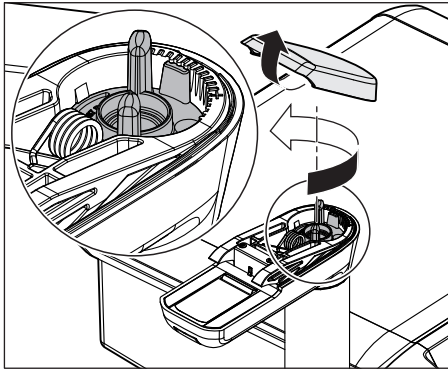

1. Remove the tray.
2. Grab under the front of the tray head cover with your fingers and pull it up and off.
3. Turn the regulating screw to set the stiffness of the rotary joint.  
Clockwise: Increase stiffness  
Counterclockwise: Decrease stiffness
4. Put the cover back on the tray head. First put the nose on the rear edge of the cover on the tray head. Then, fold the front of the cover down until it locks in place.

### 4.8.4 Cup holder

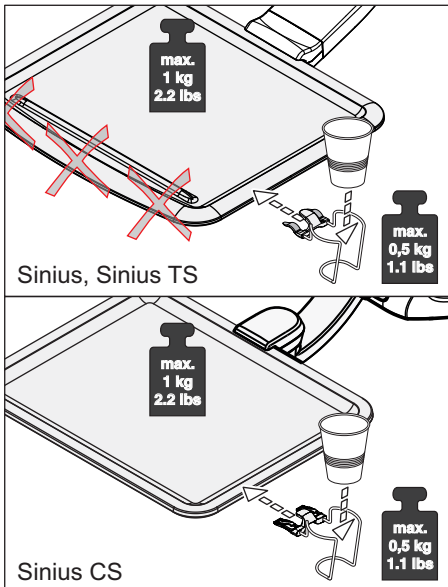

A cup holder can be attached to the tray to collect waste. It is suitable for disposable 0.2-liter cups.

For Sinius with sliding track and Sinius TS, the cup holder may not be attached to the front edge of the tray.

The maximum load of the cup holder is 0.5 kg (1.1 lbs). The load on the tray and the cup holder may not exceed a total of 1 kg (2.2 lbs).

The cup holder can be ordered from a specialized dealer. Please note the different tray systems:

Treatment center	Tray REF	Cup holder REF
Sinius (sliding track device) and Sinius TS	64 09 986	<b>65 95 321</b>
Sinius CS	64 29 042 Holder for two standard trays 64 29 059 Holder for 1 standard tray	<b>65 95 339</b>



## 4.9 Panoramic X-ray image viewer

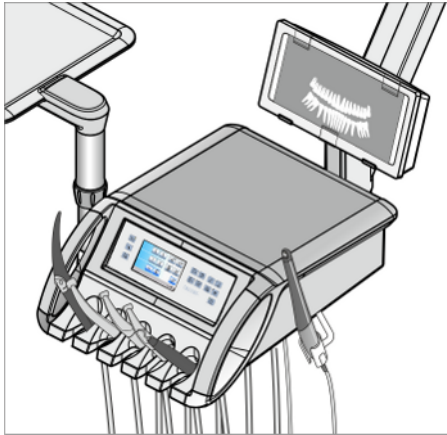

The Sinus TS treatment center can be equipped with an X-ray viewer on the support arm of the dentist element arm.

An X-ray viewer cannot be attached to the Sinus and Sinus CS treatment centers.

### 4.9.1 Switching on/off the X-ray viewer or white screen on the Sivation monitor

The white screen function can be used if the treatment center has no X-ray viewer, but is equipped with a Sivation monitor, see "Show/hide key for white screen on Sivation monitor." [→ 196]

#### WARNING

##### Misdiagnoses of X-ray images are possible

Use the white screen of the Sivation monitor **not for diagnosis** of X-ray images. The light intensity of the monitor is not sufficient.

#### Via touchscreen



- ✓ The *Start dialog* is displayed on the touchscreen.
- > Touch the *X-ray viewer* key or the *White screen* key.
  - ↪ If the key is highlighted orange, the X-ray viewer is switched on or the Sivation monitor is switched to white screen.

#### Via the assistant element

The *Hash key* on the assistant element can be configured in the setup dialog. The key allows the user to switch the X-ray viewer or the white screen function on the Sivation monitor on or off or alternatively to activate the bell or hash relay, see "Setting function of the Hash key on assistant element" [→ 196].



- > Press the *Hash key*.
  - ↪ If the *hash key* is set on the control of X-ray viewer or bell or hash relay, the LED of the key lights up when the function is activated.
  - If the White screen function is controlled in Sivation monitor using the *hash key*, the LED of the *hash key* does not light up. It is lit only when the X-ray viewer is switched on. In addition, the *White screen* key is no longer shown in orange in the *Start dialog*.

### 4.9.2 Attaching the anti-glare film

An anti-glare film is supplied with the X-ray viewer for viewing intraoral dental images.

1. Remove the three retaining clips (A).

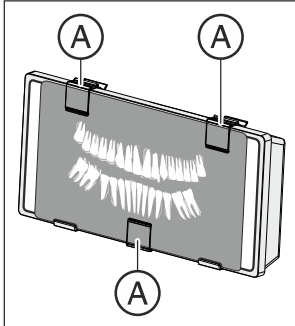

2. Use two of the retaining clips to clamp the anti-glare film (B) to the upper edge of the X-ray viewer on the left and right.
3. Use the third retaining clip to clamp the intraoral dental image at the middle of the X-ray viewer.

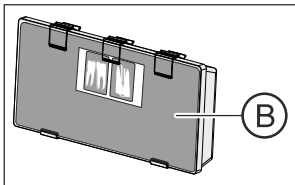

## 4.10 Operating light

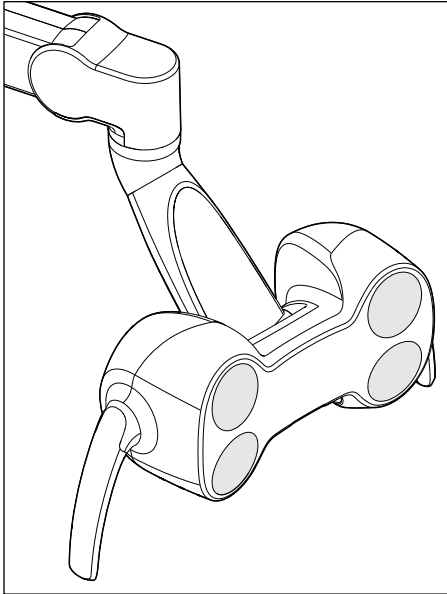

The operating light is mounted on a multi-joint support arm. It can be easily adjusted to the operating field using the handles. Brakes in the support arm hold the operating light in the position to which it has been adjusted.

The clearly defined light field illuminates the treatment area without blinding the patient.

**Tip:** The ideal working distance between the light and the patient's mouth is 70 cm/27.5 inches.

### NOTE

Also observe the instructions for use of your operating light.

### 4.10.1 Switching the operating light on/off



- > Briefly press the *Operating light* fixed key on the dentist or assistant element.
  - ↳ If the operating light is switched on, the LED of the fixed key lights up on the dentist and assistant elements.

The operating light is always switched on at the programmed brightness. The setting is programmed on the user interface of the dentist element (see below).

A non-touch sensor is installed beneath the operating light. It can be used to switch the operating light on and off or to the composite function with a hand movement. The sensor control can be switched on and off via the treatment center touch panel. Additionally, it is possible to set the distance at which the non-touch sensor should react to movement.

### 4.10.2 Setting the brightness, color temperature, and sensor control



1. Press and hold the *Operating Light* fixed key on the dentist element (> 2 s).

- ↳ The settings screen of the operating light is displayed on the touchscreen.

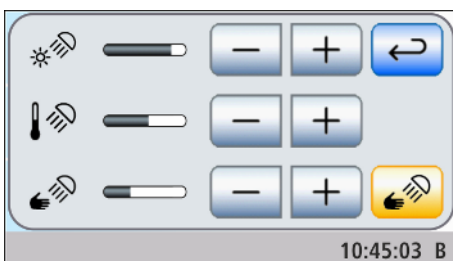

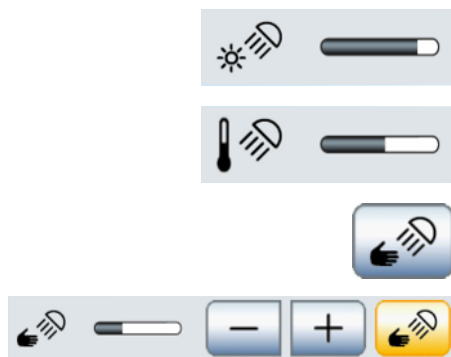

2. Use the – and + keys to set the desired brightness of the operating light (7 levels). The – key decreases the brightness and the + key increases it.
3. Use the – and + keys to set the desired light temperature of the operating light (3 levels). The – key decreases the light temperature and the + key increases it.
4. Touch the *Sensor control* key.
  - ↳ If the key is highlighted in orange, the operating light can be controlled with the contactless sensor. The keys for adjusting the operating distance are displayed.
5. Use the – and + keys to set the desired operating distance of the contactless sensor (5 levels). The – key decreases the operating distance and the + key increases it. You can try out the setting directly on the operating light without leaving the setting dialog. The setting should be selected so that the contactless sensor cannot be operated unintentionally.
6. Touch the *Sensor control* key again to switch off the sensor control.
  - ↳ The key is no longer highlighted in orange and the keys for adjusting the operating distance are hidden.

#### 4.10.3 Switching the dentist element composite function on/off

The composite function delays the curing of composite materials.



- > Press the *Composite function* fixed key on the dentist element.
  - ↳ If the composite function is switched on, the LED of the *Composite function* fixed key lights up on the dentist element. The *Operating light* key on the assistant element lights up.

#### 4.10.4 Activating operating light on the assistant element

Repeatedly press the *Operating light* fixed key to set the following switching positions at the assistant element:

1. Switched on: The operating light is switched on at the preset brightness level.
  2. Composite function: This function delays the curing of composite materials.
  3. Switched off
- > Press the *Operating light* fixed key on the assistant element (several times if necessary).
    - ↳ The operating light switches to "switched on", "composite function" or "switched off".



## 4.11 X-ray tube unit

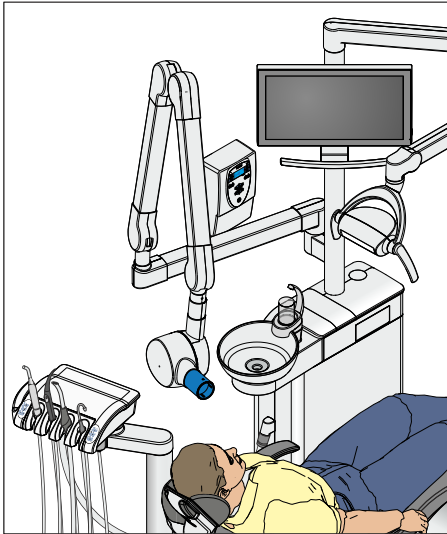

The Sinius, Sinius CS, and Sinius TS treatment centers can be equipped with the Heliodent Plus X-ray tube unit. However, for the Sinius CS, this is possible only if the dentist element is mounted in the standard position at the water unit, see section "Positioning the dentist element" [→ 78].

The X-ray tube unit is attached to the light post of the treatment center using a multi-jointed support arm that can be adjusted both horizontally and vertically. Brakes in the support arm hold the X-ray tube unit in the position to which it has been adjusted.

The X-ray parameters are set on the wall adapter of the X-ray tube unit or on a "remote timer".

The USB module for the Xios XG intraoral X-ray system can be connected to the PC via the USB interface on the dentist and assistant element. For details, please refer to the section "USB interface" [→ 190].

### WARNING

**The X-ray tube unit can be positioned within the movement range of the patient chair.**

Moving the patient chair may cause the patient to collide with the X-ray tube unit or its support arm. The patient could be injured.

- Before moving the patient chair, position the X-ray tube unit to make a collision with the patient or the patient chair impossible.

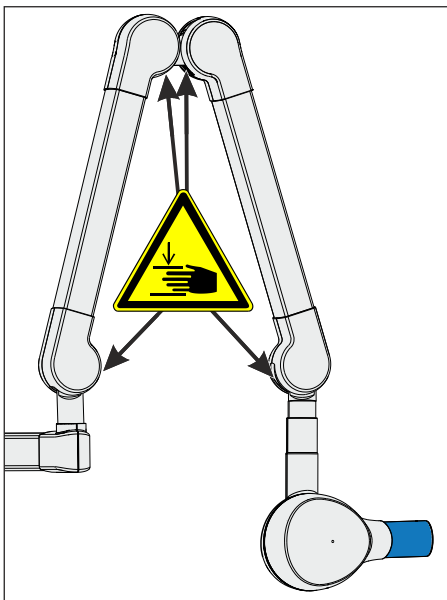

### CAUTION

**Gaps appear between the internal hinges when moving the support arm.**

Fingers may be crushed in these gaps.

- Ensure that you never place your fingers in the gaps between the hinges, neither during operation nor for cleaning purposes.

### IMPORTANT

See also the Heliodent Plus instructions for use.

## 4.12 Sivation Digital video system

The Sivation Digital video system enables intraoral and extraoral images to be made. The SiroCam AF / AF+ intraoral camera generates digital image data that can be transmitted via a USB 2.0 port (high-speed universal serial bus) to a connected PC and stored there. This computer can then display the images on the Sivation monitor of the treatment center.

The video images represent an outstanding possibility for improving patient communication.

### CAUTION

**The video images are not suitable for diagnosis.**

The Sivation Connect and/or Siucom Plus application must be installed in order to transmit the camera images to the PC. Siucom Plus enables PC control. Furthermore, a video application, e.g. Sidexis 4 or Sidexis XG and/or SI Video must be installed on the PC in order to display the camera images. For details, refer to the "Installation and configuration of Siucom Plus / Sivation Connect" manual.

### 4.12.1 Sivision monitor

#### 22" DC monitor (REF 6497452 D3655)

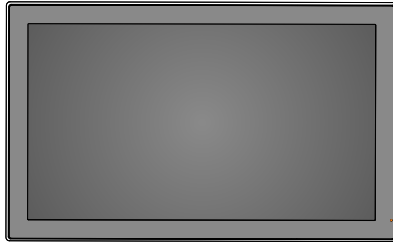

The monitor is equipped with loudspeakers and a glass screen to facilitate cleaning. For details, see "instructions for use for the 22 inch DC monitor".

#### WARNING

##### **Monitors which have not been approved must not be connected.**

They endanger the product safety of the treatment center.

- > Use only monitors that are approved according to IEC 60950-1, IEC 62368-1 (office equipment) or IEC 60601-1 (medical devices).

#### WARNING

##### **Unsuitable devices can be connected to the loudspeaker port of the monitor.**

The connection of unsuitable devices endangers the product safety of the treatment center.

- > The loudspeaker port of the monitor may be connected only to a device that complies with IEC 60950-1, IEC 62368-1 (office equipment such as PCs) or IEC 60601-1 (medical devices). Under no circumstances should it be connected e.g. to a stereo system, etc. IEC 60601-1 standards and under no circumstances to a stereo system, for example.

#### Attachment versions

##### Monitor on lamp support tube

The monitor can be rotated and swiveled.

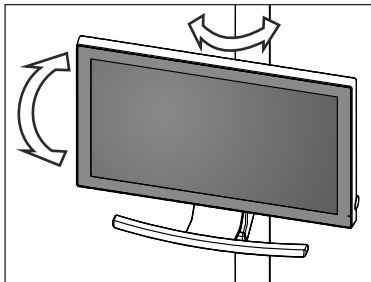

##### Monitor on tray arm

The monitor can be rotated and swiveled.

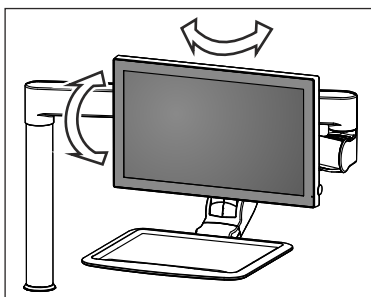

#### CAUTION

##### **The patient can collide with the monitor.**

The patient's head could collide with the monitor during movement of the patient chair or during use of the cuspidor.

- > Make sure that the patient does not collide with the monitor. Swivel the monitor out of the collision zone as soon as it is no longer required.

## 4.12.2 SiroCam AF / AF+ intraoral camera

### 4.12.2.1 Safety instructions

The SiroCam AF / AF+ intraoral camera is a sensitive optical instrument and must therefore always be handled with care.

#### NOTE

**The lens window is sensitive to scratches.**

The lens window can be damaged by hard objects. Deep scratches in the lens window impair image quality.

> Always place the intraoral camera in the designated holder and clean the lens window with a soft cloth.

#### IMPORTANT

**The intraoral camera is heated during operation due to the LEDs in the camera head.**

The following temperatures are reached at a room temperature of 23 °C:

	Operation time 1 min	Continuous operation
SiroCam AF	48°C	52°C
SiroCam AF+	46°C	50°C

### 4.12.2.2 Functional description

The camera generates digital image data using a CMOS sensor. The camera allows the acquisition of intraoral and extraoral images.

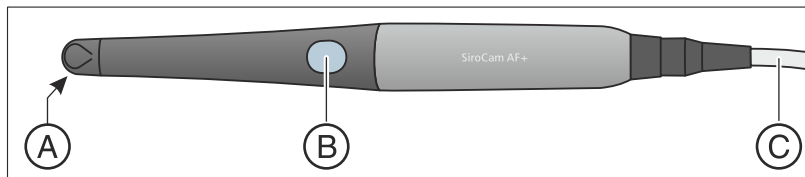

A	Lens window (covered)
B	Key for automatic focus (Auto focus)
C	Connection cable



### 4.12.2.3 Connecting the SiroCam AF / AF+ intraoral camera

#### Connecting the intraoral camera to the Sinius and Sinius TS dentist elements

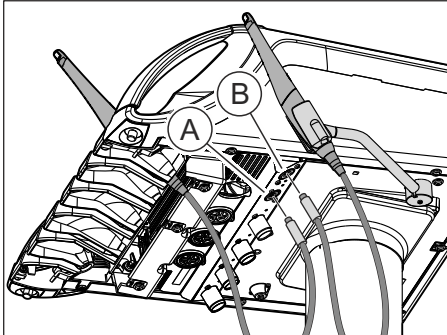

Depending on the equipment version, the intraoral camera can be placed at instrument position five or in the additional holder.

The camera connector is connected to the lower side of the dentist element. If the dentist element does not have an additional holder, the camera connection at instrument position five will be located below the dentist element **A**.

- > Plug the connector of the intraoral camera into the socket on the dentist element.
- ↳ The plug locks in place.

#### Connecting the intraoral camera to the Sinius CS dentist element

The connecting cable of the intraoral camera is guided through a swivel arm. The camera connection is located underneath the instrument holder. The holder is fixed on the front edge with two internal clamps on the dentist element.

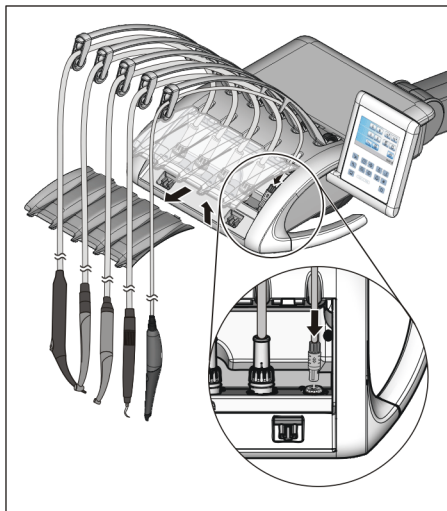

1. The instruments must be removed from the instrument holder. To do this, remove all instruments one after the other and allow these to hang down in front of the dentist element.
2. Lift the instrument holder by the front edge until the clamps are released and the holder can be removed.
3. The connection for the intraoral camera is located at the fifth instrument position. Insert the connection cable of the camera in the swivel arm and insert the camera connector into the socket.
- ↳ The plug locks in place.
4. First insert the rear edge of the instrument holder into the groove on the dentist element. Then push the holder forward and down until it locks into place.
5. Place the instruments in their holders. Make sure that the instrument hoses and the connection cable of the camera are located in the guide rollers of the swivel arm.

#### Connecting the intraoral camera to the assistant element (only with Sinius CS and Sinius TS)

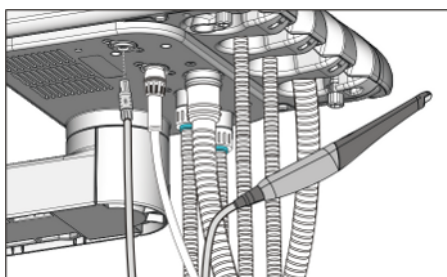

If the treatment center is equipped with the Sinius CS or Sinius TS dentist element, the intraoral camera can be operated at the first instrument position of the assistant element. The camera connection is located underneath the assistant element instead of the connection for the curing light.

- > Plug the connector of the intraoral camera into the socket on the assistant element.
- ↳ The plug locks in place.

### Removing the intraoral camera

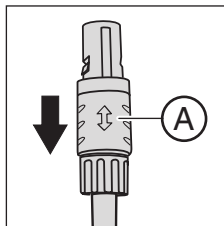

The plug of the intraoral camera is secured against unintentional removal.

- > Grasp the plug by its locking device **A** and pull this out without tilting, if possible.

#### 4.12.2.4 Operating the SiroCam AF / AF+ intraoral camera

An external or internal PC is required in order to display the video images of the SiroCam AF / AF+ intraoral camera on the Sivision monitor. The Sidexis or SI Video can be used as a PC video application.

For details please refer to chapter "Operation with a PC" [→ 184].

##### 4.12.2.4.1 Focusing SiroCam AF / AF+ intraoral camera

The SiroCam AF / AF+ intraoral camera adjusts the image focus at the touch of a button. It is focused continuously.

1. Direct the camera to the subject to be acquired.
  - ↳ The image is displayed on the Sivision monitor.
2. Press the *Auto focus* key **A**.
  - ↳ The intraoral camera adjusts the image focus according to the distance from the object to be scanned. The adjustment remains until the key is pressed again.

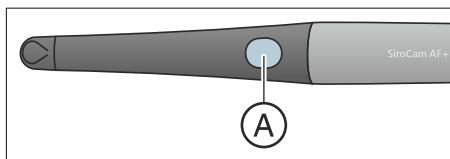

The function of focusing the camera image using the foot control can be configured in the treatment center setup, see "Switching on/off the foot control function for intraoral camera focus" [→ 195].

#### 4.12.2.4.2 Using the camera with SI Video



Using SI Video, up to four still images can be generated with the SiroCam AF / AF+ intraoral camera. These can be displayed on the Sivation monitor either as a sequence of single images or simultaneously as a quad image. The active quadrant is marked with an orange square. The quadrants are run through in a clockwise direction.

The generated still images remain until the treatment center or the PC is disconnected from the power supply.

- > Remove the intraoral camera from the holder.
  - ↳ The live image is displayed on the Sivation monitor as a single image. The *Sivation* dialog is displayed on the touchscreen.

When the intraoral camera is put in the holder, the live image is no longer displayed on the monitor. The generated still images remain displayed.



#### Operation of Si Video with the camera removed

With the camera removed, Si Video is controlled via the foot control and the Sivation dialog keys.

#### Switching between live and still image

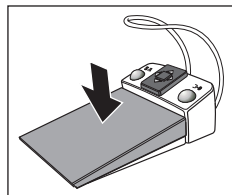

- ✓ The intraoral camera is removed from its holder.
- 1. Press the **foot pedal**.
  - ↳ The display switches from live to still image.
- 2. Press the foot pedal again.
  - ↳ The live image is displayed again.

The function of focusing the camera image using the foot control can be configured in the treatment center setup, see "Switching on/off the foot control function for intraoral camera focus" [-> 195]. In this case, the foot pedal must be pressed down fully to switch between live and still images.

#### Selecting the next quadrant

In order to produce another still image, another quadrant must be selected. If there is already a still image in the desired quadrant, it can be replaced by a new image.

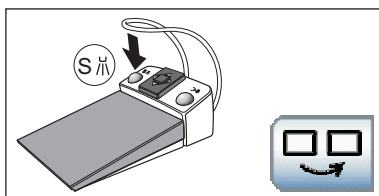

- ✓ The intraoral camera must be removed from its holder to allow for operation via the foot control.
- 1. Press the **left button** of the foot control.
  - or
  - > Touch the *Select next quadrant* key on the touchscreen.
    - ↳ The orange square highlights the selected quadrant. When the intraoral camera is removed, the live image is displayed.

### Switching between quad image and single image

When switching from quad to single image, the previously marked quad image is displayed as a single image. Conversely, the displayed single image is marked in the quad image.

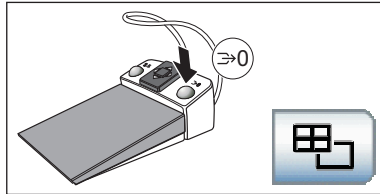

✓ The intraoral camera must be removed from its holder to allow for operation via the foot control.

1. Press the **right button** of the foot control.

or

> Touch the *Quad image* key on the touchscreen.

↩ The mode changes between quad and single image.

### Operation of Si Video with the camera in place

When the camera is in the holder, Si Video is controlled via the Sivision dialog buttons.



#### Selecting the next quadrant

In single image mode, the still image in the next quadrant is displayed. In quad image mode, the next quadrant is highlighted.



#### Quad image

Display quad image or single image. Up to four single images are simultaneously displayed on the Sivision monitor in quad image mode.



#### Deleting images

All generated still images are deleted.

#### 4.12.2.4.3 Using the camera with Sidexis



Besides displaying and processing X-ray images, Sidexis 4 and Sidexis XG can be used additionally as a video application for the SiroCam AF / AF+ intraoral camera. Sidexis displays live and still images in separate windows. Still images are saved in the patient database.



Some functions of Sidexis 4 and Sidexis XG can be controlled via the user interface of the treatment center, see "Communication with Sidexis" [-> 187].

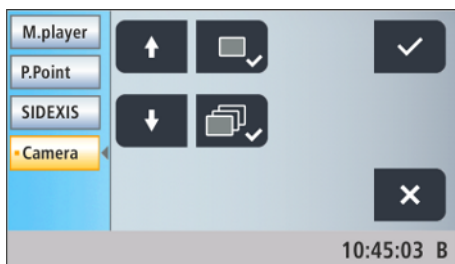

An additional video plugin must be installed if the intraoral camera is used in combination with Sidexis 4. Please refer to the "Video plugin for Sidexis 4" user manual for details on installing and using the plugin. The video plugin can be controlled via the user interface of the treatment center with version 2.0 and higher, see "Communication with video plugin" [-> 189].

### Switching the SiroCam AF / AF+ intraoral camera on/off

- ✓ The PC is in operation and the Sivation Connect or Siucom Plus PC application is started.
- > Take the SiroCam AF / AF+ intraoral camera from the holder.
  - ↳ The *Sivation* screen appears on the touchscreen. Sidexis is started and the live image appears on the Sivation monitor.

When the intraoral camera is returned to the holder, the live image window closes. Sidexis remains active on the PC.

### Generating a still image

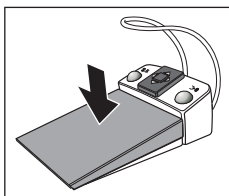

- ✓ The live image is displayed on the Sivation monitor.
- 1. Step on the **foot pedal**.
  - ↳ The display switches from live to still image.
- 2. Press the foot pedal again.
  - ↳ The live image is again displayed on the Sivation monitor.

The function of focusing the camera image using the foot control can be configured in the treatment center setup, see "Switching on/off the foot control function for intraoral camera focus" [→ 195]. In this case, the foot pedal must be pressed down fully to switch between live and still images.

### Saving an image

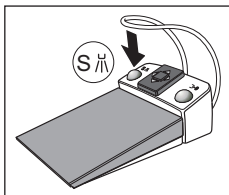

- ✓ The patient must be registered in Sidexis.
- ✓ The still image to be saved is displayed on the Sivation monitor.
- > Press the **left button** of the foot control or put the camera back in the holder.
  - ↳ An acoustic signal sounds.
  - ↳ In Sidexis 4, the still image is saved in the side image bar of the video plugin. For the final export in Sidexis 4, see "Communication with the video plugin" [→ 189].  
For Sidexis XG, the still image is displayed in an additional Sidexis window and saved in the patient database.

### Focusing and automatically saving the image

When using Sidexis 4 version 4.2 or higher in combination with the video plugin version 2.0 or higher, we recommend selecting the third option in the setup dialog for focusing the intraoral camera, see "Switch focusing the intraoral camera on/off by the foot switch" [→ 195]. The images can then be displayed automatically on the Sivation monitor in the side image bar of the video plugin. Saving the still image with the left button (S) of the foot switch and switching between live and still image is thus no longer necessary.

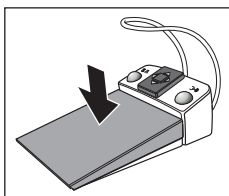

- ✓ The live image is displayed on the Sivation monitor.
- > Press the **foot pedal**.
  - ↳ The live image is focused and automatically saved in the side image bar of the video plugin.

#### 4.12.2.5 Technical camera data

##### General technical data

Model:	Intraoral camera	
	SiroCam AF	SiroCam AF+
Weight of handpiece without cable:	approx. 80 g	approx. 85 g
Dimensions:	diam. 27.5 x 207 mm	
Working temperature:	+10 to +40 °C	
Power supply and signal output:	5 V via USB 2.0 interface (modified plug-in connection)	

##### Characteristics of the image acquisition

Lighting:	2 white light LEDs
Image sensor:	1/4" CMOS
Live image resolution:	824 x 514
Resolution of saved images:	1024 x 640 with SiroCam AF 1276 x 796 with SiroCam AF+
White balance:	Permanently set to 4800 K

## 4.13 Operation with a PC

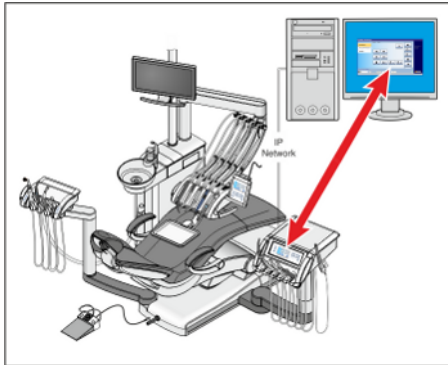

The treatment center can be connected to a PC via an Ethernet cable. The Sivation Connect and/or Siucom Plus PC application enables communication between the treatment center and the PC. Siucom Plus is required for PC control. This allows the PC to be operated directly via the touchscreen and in connection with the SiroCam AF / AF+ intraoral camera, via the foot control of the treatment center.

For details, please refer to the "Installation and configuration of Siucom Plus / Sivation Connect" manual.

### **⚠ CAUTION**

**Integrating the Sinuis into an IT network that includes other devices can lead to previously unknown risks.**

The following changes to the IT network can lead to new risks:

- Changes to the IT network configuration
- Connecting additional elements to the IT network
- Removing elements from the IT network
- Updating devices that are connected to the IT network
- Upgrading devices that are connected to the IT network

The provider of the IT network must determine, analyze, assess, and control the risks (e.g. IEC 80001-1).

The treatment center can be operated with the following PC versions:

- **External PC**  
The treatment center is connected to an external PC via an Ethernet cable. PC applications such as Sidexis, Microsoft® PowerPoint®, Windows Mediaplayer and SI Video can be controlled from the treatment center.
- **Internal PC**  
The treatment center is operated as a standalone unit without an external PC. A mini PC is integrated in the base of the chair instead. It is required to display the camera images using the SI Video PC application. This version is not intended for image storage or the control of any additional PC applications.
- **Operation without PC**  
The use of Sivation is not possible.

The SI Video application is used in treatment centers with an external PC on which Sidexis is not installed, or with an internal PC (standalone solution). In these cases, SI Video serves as a video application for the camera.

### **IMPORTANT**

**The PC's HDMI outlet and graphics card should be hot-plug capable.**

When the PC is switched on before the treatment center, the Sivation monitor may remain black in some PC models.

- In this case, switch the treatment center on first, then the PC..
- Equip your PC with a hot-plug capable HDMI outlet. Then the devices can be switched on in any order.



### 4.13.1 Sivision program

Various PC applications of the PC can be started and operated in the Sivision program.

The PC applications to be operable via the treatment center can be set in Siucom Plus. The keys displayed on the touchscreen and their arrangement can be adjusted individually. See the "Installation and configuration of Siucom Plus / Sivision Connect" manual.

The network connection of the treatment center must be configured in the setup dialog before using the Sivision dialog, see "Configuring the network connection" [→ 201].

PC applications can be controlled from the treatment center only if they were started via Siucom Plus.

#### 4.13.1.1 Starting PC communication

##### Opening the Sivision dialog

- ✓ All PC applications which were started from the treatment center have been terminated.
- ✓ Siucom Plus has been started, e.g. via autostart.



1. Touch the *Sivision dialog* change key at the left next to the touchscreen.

or

- > For intraoral images: Remove the SiroCam AF / AF+ intraoral camera from the holder. The Sidexis or SI Video PC application starts immediately.

↳ The *Sivision dialog* appears on the touchscreen.

##### Starting other PC applications

1. Select the desired PC application from the left side of the touchscreen.
  - ↳ The key of the selected PC application is highlighted orange and the corresponding control keys are displayed on the right side of the touchscreen; see the following sections. The PC application is automatically started on the PC.
2. The *File selection* program opens for PC applications that can access files of the PC. Select the desired file by touching it.
  - ↳ The control keys of the relevant PC application are displayed on the touchscreen.

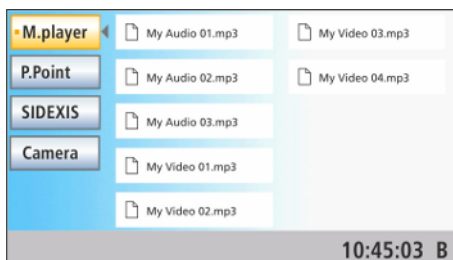

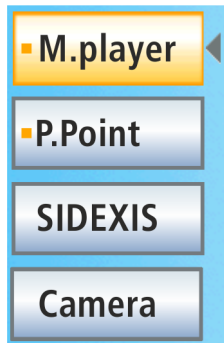

The treatment center starts the PC applications automatically. An orange square located in front of the respective PC application on the touchscreen indicates whether the application has been started and is ready for operation on the PC. If the orange square is not displayed, communication with the PC application is not yet possible.

#### 4.13.1.2 Communication with the media player



The treatment center has the option of playing back multimedia files stored on the external PC using the Windows Media Player. Audio or video files can be selected from the file system and the Media Player can be controlled from the treatment center. Video images can be viewed on the Sivation monitor.

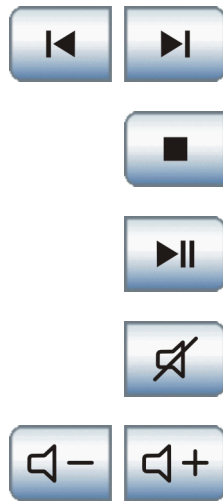

Previous/next title

Stop playback

Start/interrupt playback

Mute

Adjust volume

#### 4.13.1.3 Communication with Microsoft PowerPoint

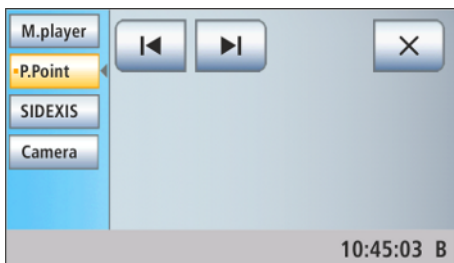

For effective patient communication, Microsoft® PowerPoint® presentations stored on the external PC can be displayed on the Sivation monitor. The presentations in the file system can be selected and the display of slides can be controlled from the treatment center.



Previous/next slide

#### 4.13.1.4 Communication with Sidexis



The Sidexis 4 and Sidexis XG PC applications can display X-ray and intraoral camera images on the Sivation monitor. They can save images taken with the SiroCam AF / AF+ intraoral camera in the patient database. The following Sidexis functions can be controlled from the treatment center:

For more details, please refer to the "Sidexis 4" or "Sidexis XG" user manual.



##### Next image

The next image window is activated.



##### Tiled layout

All open image windows are scaled to a uniform size in the display area and arranged without overlapping.



##### Cascaded layout

The opened windows are "cascaded", i.e. arranged slightly displaced behind one another. All image window titles are thus visible.



##### Overview layout

The opened image windows are scaled in the display area so that no scroll bars or as few scroll bars as possible must be displayed. The image windows are arranged without overlapping.



##### Full frame

The active image window is enlarged so that it covers the entire display area. The control elements of the Sidexis user interface are not concealed in the process.



##### Zoom in/out

This magnifies and decreases the active image window and the size of the image displayed in it on the Sivation monitor.



##### Rotate image

Rotates the image 90° counterclockwise or clockwise. With Sidexis 4, the image can be rotated 180° by pressing a key.



#### Contrast optimization filter

This image filter analyses and optimizes the current grayscale distribution of an image. In this way, for instance, details within a very low-contrast, "faint" image can be made visible.



#### Relief display filter

Image details with high contrast are displayed brighter or darker. Edges or contours within the image are thus clearly accentuated. The result is a relief-like image distortion.



#### Smooth image

To mitigate high-contrast or high-interference effects in images, the contrast between neighboring pixels is reduced or averaged. The overall definition of the image is reduced.



#### Sharpen image

Contrasts between neighboring pixels are increased. This function helps to accentuate edges or contours. This gives the impression of a sharper image.



#### Invert image

This function inverts the brightness values of the image pixels, thus enabling a positive or negative display of the image. The inversion can be canceled by pressing the key once again.



#### Display image in pseudocolors

To enable better distinction of image details, an image can be displayed in what is called pseudo color mode. The grayscale values of the image are replaced by colors which the human eye can distinguish better from one another than the corresponding gray levels.



#### Filter black dots

Single pixel errors may occur when taking digital X-rays. These pixel errors appear as individual black dots when the optimum resolution (100%) is selected. They are removed by Sidexis.



#### Reducing noise

Individual scattered pixels and minor disturbing information which lead to a noisy image are eliminated without reducing the overall definition of the image.



#### Undo

The effect of the last filter operation is undone.



#### Restore original image

The changes previously made, e.g. via filters, are canceled. The most recently saved version of the image is restored.



#### Close current media window



#### Close all media windows



**Cancel/confirm entry**



**Accept an order**

Accepts an order that was placed and is waiting in Sidexis, e.g. for creating an intraoral image with the X-ray unit of the treatment center or a video recording with the intraoral camera.



**Readiness for intraoral X-ray exposure**

Establishes readiness for an X-ray exposure. A Sidexis window then opens where the image type can be selected and the image can be described in detail.

#### 4.13.1.5 Communication with video plugin

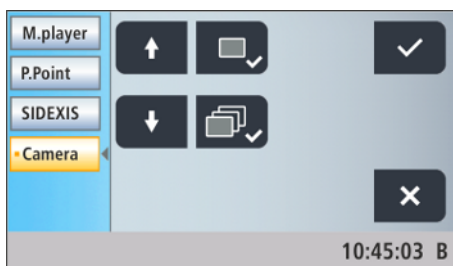

The video plugin for Sidexis 4 can be controlled via the user interface of the treatment center in versions 2.0 and higher. After replacing the SiroCam AF / AF+ intraoral camera, the last image taken is displayed in the main window of the video plugin. In an image bar at the side, a preview of all images taken is displayed. The image displayed in the main window is highlighted orange. Via the touchscreen of the treatment center, the images taken can be selected and marked for final export to Sidexis. Unmarked images are discarded.

For more details, refer to the "Video plugin for Sidexis 4" user manual.



**Scroll up / select previous still image**



**Scroll down / select next still image**



**Mark selected still image for import to Sidexis 4**



**Mark all still images for export to Sidexis 4**



**Import marked still images to Sidexis 4**



**Discard all still images**

**Note:** The Siucom Plus PC application can be used to configure the layout of the keys.

For a description of the *SI Video* Sivation dialog, please refer to the section "Using the camera with SI Video" [-> 179].

### 4.13.2 USB port

A USB 2.0 port is provided on the back of the dentist element.

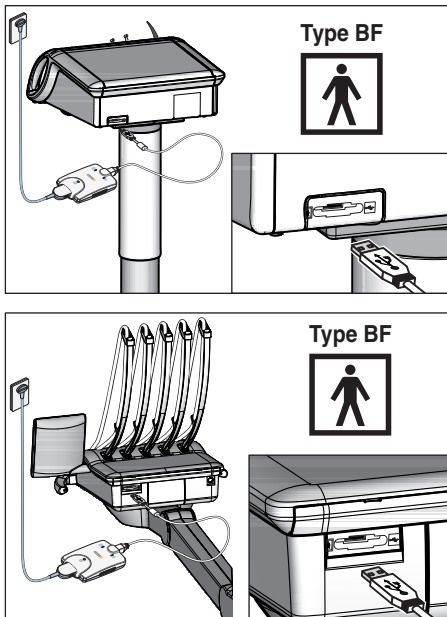

#### **⚠ CAUTION**

**In the event of electrical faults, mains voltage could be conducted to the USB interface via the protective conductor.**

There is a risk of electric shock.

- Only type BF medical devices and applied parts according to IEC 60601-1, e.g., the Dentsply Sirona Xios XG USB module intraoral X-ray system, may be connected to the USB interface.
- Do not connect extension cables to the USB interface.

#### **⚠ CAUTION**

**USB devices with their own voltage supply (e.g., via a power supply unit) may lead to increased leakage current.**

This endangers the safety of patients and users.

- Connect only USB devices that use the USB connection as their exclusive power source.

## 4.14 Configuration of the treatment center (setup)

Various treatment center functions can be individually configured via the Setup settings. The treatment center can therefore be adapted to match each user's personal method of treatment.

### 4.14.1 Opening the setup programs

- ✓ All instruments are in place.
- ✓ The required user profile is active.
- > Press and hold the *Setup* fixed key (approx. 3 s).



- ✎ Six setup programs are offered for selection.

The current software version of the treatment center is displayed on the left side of the touchscreen.

Key symbols of the six setup programs row by row from left to right:

- EasyTouch user interface
  - Date and time
  - Control options
  - Instruments
  - Network connection
  - Service domain (for service engineers only)
- > Touch the corresponding key to open the Setup dialogs.



Some of the setup programs comprise several pages. Using the *Scroll forward* key, you can switch to the next Setup dialog page.

#### IMPORTANT

##### Setup dialog, storing settings

The setup dialog closes automatically if no key is activated in 25 seconds. All of the settings you have made will be accepted when you leave the setup dialog.

#### IMPORTANT

##### Missing function keys

Function keys for functions which the treatment center equipment does not include are not displayed on the touchscreen.

## 4.14.2 Configuring the EasyTouch user interface



> Touch the *EasyTouch user interface* key in the setup program.

↪ The sub-screen opens.

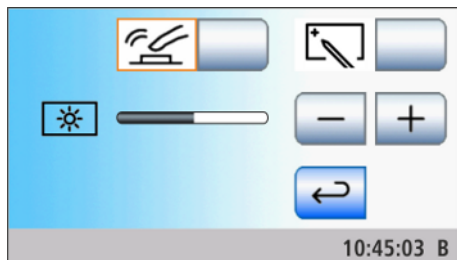

### 4.14.2.1 Switching the key sound on/off

The program can be set to issue an acoustic signal that sounds when the operator touches a key on the touchscreen or a fixed key.

> Touch the *Key tone* key.

↪ If the key is highlighted orange, the key tone is activated.



### 4.14.2.2 Calibrating the touchscreen

If the touchscreen is no longer able to precisely locate the position of a contact, it must be recalibrated.

1. Touch the *touchscreen calibration* key.

↪ A calibration field is displayed.

2. Touch the small cross on the touchscreen with a blunt pen.

↪ The cross is displayed at another location on the touchscreen.

3. Repeat this procedure until the cross no longer appears.

4. Touch the empty touchscreen again.

↪ The touchscreen is now calibrated. The *User interface* setup dialog is displayed again.



### 4.14.2.3 Adjusting the touchscreen brightness

> Use the – and + keys to set the brightness of the touchscreen.





### 4.14.3 Setting the date and time



- > Touch the *Date and time* key in the setup dialog.

↳ The sub-dialog opens.

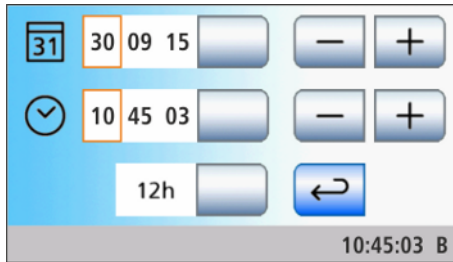

#### Setting the date

The date is displayed in the format day/month/year.

1. Use the – and + keys to set the day.
2. Touch the *Date* key.
  - ↳ The month field is highlighted orange.
3. Repeat this procedure for the month and year.



#### Set the time

1. Use the – and + keys to set the hour.
2. Touch the *Time* key.
  - ↳ The minutes field is highlighted orange.
3. Use the – and + keys to set the minutes.



#### Switching 12/24 hour display

The 12-hour display is only changed in the status bar of the touch screen. The setup dialog will continue to display a 24-hour system.

- > Touch the *12/24 hour display* key.
  - ↳ If the field is highlighted orange, the 12-hour display is set.

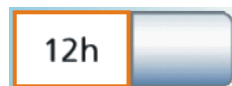

#### Activating/deactivating time synchronization

With Sidexis 4, the treatment center can synchronize the date and time on the PC.

- ✓ The treatment center is connected with a Sidexis 4 PC on which the dental unit plug-ins are installed.
- > This function can be switched on and off at the PC with the dental unit plug-in "Time synchronization". For more details, refer to the "Dental unit plug-ins" user manual.
  - ↳ When time synchronization is activated, the setting keys for the time and date are hidden in the setup dialog.

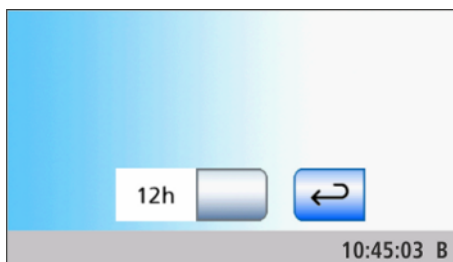

### 4.14.4 Configuring control options

Operation of the entire treatment center operation can be configured in this dialog.

- > Touch the *Control options* key in the setup program.



- ↪ The sub-dialog opens.

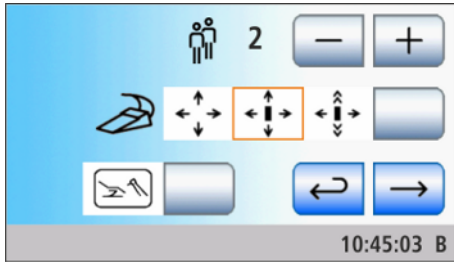

#### 4.14.4.1 Preselecting the number of user profiles

If fewer user profiles are required, their number can be limited so that only the specified users can be selected after the treatment center is switched on.

- > Use the – and + keys to set the number of user profiles.

If the number of user profiles is limited to one, the *User profiles* key is hidden in the start dialog.



#### 4.14.4.2 Setting the cursor control

The cursor control can be set as follows:

- Field 1: Cursor control switched off
- Field 2: Cursor control switched on, without screen change
- Field 3: Cursor control switched on, with screen change:

For more information, please refer to "Using the cursor control" [→ 60].

- ✓ A cable foot control is connected to the treatment center or a wireless foot control is registered on the treatment center; see "Setting the wireless foot control on the treatment center" [→ 58].

- > Touch the *Cursor control* key.

- ↪ The selected field is highlighted orange.



#### 4.14.4.3 Select the operating mode of the Start program

The Start dialog can run in two operating modes. In the operating mode, *Standard Start dialog*, the functions of the patient chair and instruments are each shown on separate screens. In the operating mode, *EasyMode Start dialog*, the patient chair and instrument functions that are most important for the treatment are shown together on the same screen. For further details on the operating modes, see "Start dialog operating modes" [→ 53].

- > Touch the *Start dialog operating mode* key.

- ↪ If the key is highlighted orange, the *EasyMode Start dialog* is displayed.

- > Change to the next setup dialog page.



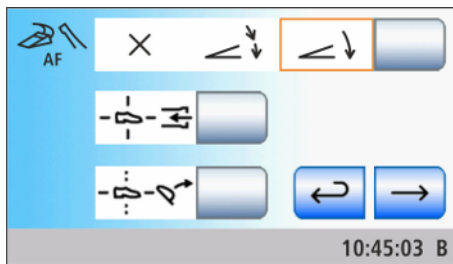

#### 4.14.4.4 Switching on/off the foot control function for intraoral camera focus

The foot control can be set to focus the SiroCam AF / AF+ intraoral camera:

- Field 1: The display switches between a still or live image when the foot pedal is pressed. The knob on the camera can be used to focus the image.
- Field 2: The camera is focused by pressing the foot pedal. The display switches between a still or live image only when the foot pedal is pressed down fully. The knob on the camera can still be used to focus the image.
- Field 3: When the foot pedal is pressed, the camera image is focused and a still image is automatically taken. The knob on the camera can still be used to focus the image.



- > Touch the *Autofocus* key.
  - ↳ The selected field is highlighted orange.

Please note that the *Autofocus* key is displayed in the setup dialogue only when the PC is switched on and the autofocus camera is configured for use on this treatment center. The latest version of the SIUCOM Plus / Sivision Connect application must be installed on the PC. For details, please refer to the "Installation and configuration of Siucom Plus / Sivision Connect" manual.

When using Sidexis 4 version 4.2 and higher in combination with the video plugin version 2.0 or higher as a PC application for the intraoral camera, we recommend selecting the third option for focusing the camera. The images are then displayed automatically in an image bar on the Sivision monitor. Saving the still image with the left button (S) of the foot switch and switching between live and still image is thus no longer necessary. For details, please see the section "Using the camera with Sidexis" [→ 181] and the "Video plugin for Sidexis 4" user manual.

#### 4.14.4.5 Linking the spray aspirator to the 4-way foot switch

A setting can be made to enable interruption and/or reactivation of the suction flow of the spray aspirator by pressing the 4-way foot control in any direction. This function cannot be used on the saliva ejector. Follow the safety instructions, see "Suction handpieces" [→ 153]

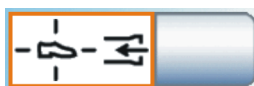

- > Touch the *Spray aspirator* key.
  - ↳ If the key is highlighted orange, the removed spray aspirator can be switched on/off with the 4-way foot switch.

If you deposit the spray aspirator in its holder while the suction flow is interrupted, the suction flow is automatically restarted when you pick it up again.

#### 4.14.4.6 Linking the headrest tilt to the 4-way foot switch

If a motor-driven headrest is used, control of the tilt patient couch function using the 4-way foot control can be replaced by the headrest tilt function.



- > Touch the *headrest tilt* key.
  - ↳ If the key is highlighted orange, the tilt of the motor-driven headrest can be adjusted to the left and right using the 4-way foot control.
- > Change to the next setup dialog page.

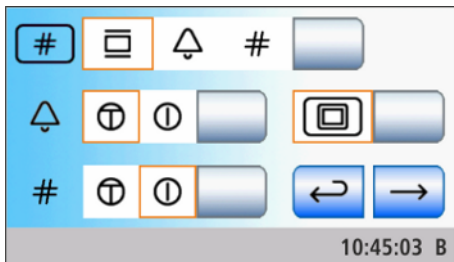

#### 4.14.4.7 Setting the hash key function on the assistant element

The *Hash key* on the assistant element can be assigned the X-ray viewer function or, if the X-ray viewer function is set to the white screen on the Sivision monitor, it can be assigned the white screen function. See "Key for showing/hiding white screen on Sivision monitor" [-> 196].

Alternatively, the *Hash key* on the assistant element can also be used to activate the bell or hash key, e.g. if neither an X-ray viewer or a Sivision monitor is available.



- > Press the *X-ray viewer*, *bell*, or *hash* key.
  - ↳ The selected field is highlighted orange.

#### 4.14.4.8 Setting the bell/hash fixed key as a pushbutton or as a switch

The relay assigned to the bell and hash keys can be actuated as a push button or a switch.

- Field 1: Push button
- Field 2: Switch

- > Touch the *Bell* and/or *Hash* key.
  - ↳ The selected field is highlighted orange.

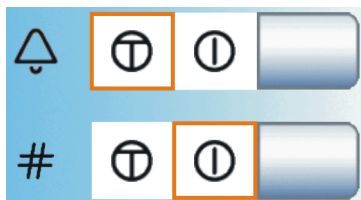

#### 4.14.4.9 Key for showing/hiding white screen on the Sivision monitor

If the treatment center has no X-ray viewer but is equipped with a Sivision monitor, the Sivision monitor can be set to the white screen mode.



- > Touch the *White screen* key.
  - ↳ If the key is highlighted orange, the *White screen* key is displayed in the *Start dialog*.



> Change to the next setup dialog page.

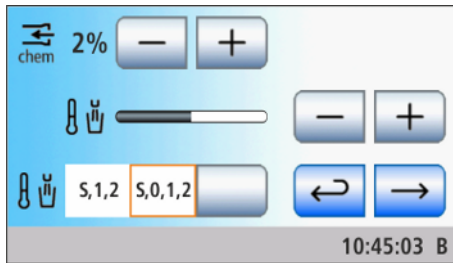

#### 4.14.4.10 Adjust cleaning agent mixture for chemical suction hose cleaning

The suction system can be cleaned by pumping water into a tank behind the receptacle of the suction hoses and extracting it from there. A cleaning agent is added to the water if the dental treatment center is equipped with the chemical suction hose cleaning option. For more information, see the section "Cleaning the suction hose" [→ 241].

It is possible to set how much cleaning agent should be added to the water for chemical suction hose cleaning. The quantity is dependent on the cleaning agent used and the type of treatment. Please follow the manufacturer's instructions for the cleaning agent.



- > Use the – and + keys to adjust the cleaning agent mixture for chemical suction hose cleaning (0 to 5%).
  - ↳ The percentage set is displayed on the touch panel.

#### 4.14.4.11 Switching the central supply for chemical suction hose cleaning off and on

For clinical use, Sinus treatment centers can be equipped with a central cleaning agent supply for chemical suction hose cleaning. The CDS 60 system of Dürr Dental is intended for this purpose.

The cleaning agent is pumped from the central supply station to the treatment centers via an in-house tubing or hose system. There it is mixed with water and suctioned off through the suction hose adapters at the water unit.



- > Touch the *Dürr CDS* key.
  - ↳ If the key is marked orange, the treatment center is switched to the central supply for chemical suction hose cleaning.

#### NOTE

The CDS 60 station may be operated only with a cleaning agent approved by Dürr Dental and Dentsply Sirona, e.g. Orotol plus.

#### IMPORTANT

Also observe the "CDS 60" instructions for installation and use from Dürr Dental.

#### 4.14.4.12 Adjusting the temperature of the tumbler heater

The water temperature for the tumbler filling can be adjusted.



- > Use the – and + keys to set the intensity of water heating using tumbling heater.

#### 4.14.4.13 Linking the tumbler heater to the chair program

A setting can be made so that the tumbler heater automatically switches off when the entry/exit position (0) chair program is activated. The tumbler heater switches back on as soon as the patient chair leaves the entry/exit position. This makes it possible for the patient to drink cold water during waiting periods and to save energy.

- Field 1: The tumbler heater is switched off in the chair program entry/exit position (0).
- Field 2: The tumbler heater remains switched on in every chair program.

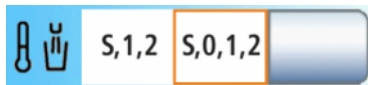

- > Touch the *Tumbler heater* key.
  - ↪ The selected field is highlighted orange.

### 4.14.5 Configure instruments



- > Touch the *Instruments* key in the setup program.

↳ The sub-screen opens.

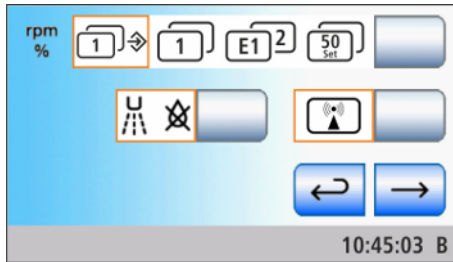

#### 4.14.5.1 Preselecting how instrument settings are to be saved

The settings in the instrument programs can be made either via static quick setting keys (with the key values 0.09 or 2, 20, 40 or 1, 50, 100), via the programmable quick setting keys (with changeable key values) or via the function levels (E1, E2). For more information see "Quick setting keys and function levels" [→ 86] and "Saving the instrument settings" [→ 199].

When using the static quick setting keys, you can choose one of two options for saving the settings you made in the instrument dialog:

- SaveMode – The *Memory* key is displayed in the Instrument programs:  
The settings made in the Instrument dialog will be saved after the instrument is placed in its holder only if the Memory key was pressed and held beforehand (> 2 s).
- DropMode – *Memory* key hidden in Instrument programs:  
When the instrument is deposited, the settings made in the Instrument dialog are automatically saved.

One of the following presettings can be selected:

- Field 1: Static quick setting keys with SaveMode
- Field 2: Static quick setting keys with DropMode
- Field 3: Function levels
- Field 4: Programmable quick setting keys



- > Touch the *Select memory type* key.  
↳ The selected field is highlighted orange.

#### 4.14.5.2 Switching afterblow on/off

After the foot control pedal has been released, the cooling spray remaining in the instrument head or in the tip of the instrument can be automatically blown out by briefly activating the chip blower.



- > Touch the *Afterblow* key.  
↳ If the key is highlighted orange, the afterblow function is activated.

#### 4.14.5.3 Showing/hiding the key for the external HF surgical unit

External HF surgical devices may interfere with the treatment center and Sivation monitor. Therefore, the *External HF surgical devices* key may be displayed on the *Start* sub-dialog. If the key in the sub-dialog is highlighted in orange, the treatment center is protected from interference resulting from the HF fields.



- > Touch the *External HF surgical unit* key.
  - ↳ If the key is highlighted orange, the *external HF surgical unit* key is displayed in the *Start* sub-dialog.

If the suction system is required with the external HF surgical unit during the treatment, the suction handpiece must be removed from the holder before blocking the treatment center. The suction unit remains switched on until the block is removed and the suction handpiece is returned to the holder.



- > Change to the next setup dialog page.

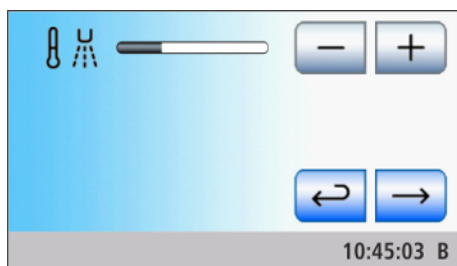

#### 4.14.5.4 Setting the spray temperature

The spray temperature of instruments on the dentist element except for the Sprayvit M multifunctional syringe can be adjusted.

The spray temperature of the Sprayvit M multifunctional syringe can be adjusted separately, see "Switching the instrument light on/off and setting the water temperature" [→ 102].



- > Use the – and + keys to set the spray temperature.



#### 4.14.6 Configuring the network connection



> Touch the *Network connection* key in the setup dialog. Berühren Sie im Setup-Dialog die Taste Netzwerkverbindung.

↳ The sub-dialog *Network connection* opens. It shows the currently used network configuration.

Call in your data processing specialist for network configuration.

Network configuration is described in detail in the "Sinius / Sinius CS / Sinius TS installation instructions".

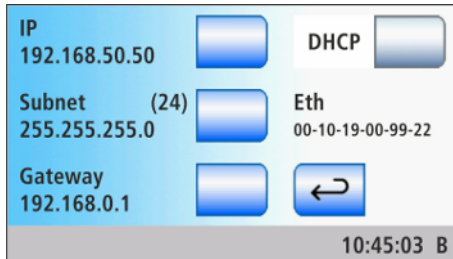

#### 4.14.7 Opening the service function



The Service domain is intended to be used only by service engineers.

#### CAUTION

A user operating error may cause malfunctions and hazards.

> Please contact your service technician or your dental depot.

## 5 Care, cleaning and maintenance by the practice team

### 5.1 Basics

Reprocessing involves the following steps:

- Pre-cleaning
- Cleaning
- Disinfection
- Sterilization if possible

The treatment center must be reprocessed immediately, or at the latest, one hour after treatment. Pre-cleaning should be done with disposable/paper towels.

Inappropriate care and cleaning of the device can result in malfunction or damage. Qualified personnel must be trained in the handling of medical devices.

#### 5.1.1 Intervals

To maintain the value and safe functioning of your treatment center, it is necessary to have it regularly maintained, cleaned, and disinfected by the practice team. This will minimize the risk of contamination for patients and users and ensure proper functioning.

The national requirements and recommendations for hygiene and disinfection must be observed, e.g. Robert Koch Institute (RKI), American Dental Association (ADA), Centers for Disease Control and Prevention (CDC), etc.

#### **IMPORTANT**

##### **Maintenance, cleaning, and disinfecting intervals**

The time intervals specified for maintenance, cleaning, and disinfection/sterilization are reference values.

Please adapt the time intervals to suit your personal method of working and your national requirements.

#### **In the morning**

Automatically purge water lines (AutoPurge function) [→ 220]

Flush water lines [→ 217]

#### **After each patient**

Clean the gold trap [→ 248]

Clean/disinfect the cuspidor [→ 249]

Purge the water lines (purge function) [→ 217]

Lubricate, disinfect/sterilize the treatment instruments [→ 226]

Clean and disinfect/sterilize the components of the ApexLocator [→ 233]

Clean the suction hoses [→ 241]

Sterilize the suction cannula [→ 245]

Clean/disinfect surfaces [→ 207]

Disinfect the upholstery [→ 213]

Disinfecting the EasyTouch [→ 208]

Disinfect handles [→ 209]

Maintaining and cleaning the operating light (see separate instructions for use for the operating light)

### **In the evening**

Automatically purge water lines (autopurge function) [→ 220]

Clean the suction system using the suction hose adapter for the cuspidor or via an external tank [→ 243] (if the chemical suction hose cleaning option is not available)

Clean the filter in the suction hoses and disinfect/thermally disinfect the suction hoses [→ 246]

Thermally disinfect the instrument holder of the dentist and assistant element and sterilize silicone mats [→ 214] and [→ 216]

Disinfect the tray [→ 211]

Disinfect the cup holder [→ 212]

### **Weekly**

Clean and care for upholstery [→ 213]

Clean the bottom surface of the mount for the backrest component [→ 213]

Clean the foot control [→ 216]

Clean outlet lines [→ 250] (if chemical suction hose cleaning option available)

Change the cotton roll on the turbine hose and oil collector [→ 239]

Sterilize/disinfect and lubricate the suction handpieces [→ 245]

Thermodisinfect cartridges for adapters for sanitization and suction hose cleaning [→ 253]

### **Monthly or as required**

Change the water and air filters [→ 254]

Microbiological water test [→ 204]

Maintain treatment instruments [→ 236]

Check the flow rate on the Sprayvit M multifunctional syringe [→ 229]

Interactively guided or manual sanitization of the treatment center [→ 264]

Change the amalgam rotor [→ 255] or  
empty the sediment container [→ 259] or  
clean the filter insert of the standard wet suction [→ 261]

Check the message system of the amalgam separator [→ 258]

Changing the battery of the wireless foot control [→ 277]

For a quick overview of the work involved, see the "Care and cleaning plan" for the Sinius treatment center.

### 5.1.2 Care, cleaning, and disinfecting agents

#### NOTE

##### Approved care, cleaning, and disinfecting agents

Use only care, cleaning, and disinfecting agents approved by Dentsply Sirona!

A continuously updated list of approved agents can be downloaded on the internet from the online portal for technical documents. You can reach this portal at the address:

[www.dentsplysirona.com/manuals](http://www.dentsplysirona.com/manuals)

Click on the menu items "General documents", "All products" and then open the "Care, cleaning and disinfection agents" document (REF 59 70 905).

### 5.1.3 Microbiological water test

Perform the microbiological test of the water from the treatment center at regular intervals and after longer periods of disuse > 1 week; see "Media quality" [→ 15]. Start the checkups in intervals of no more than two weeks and adjust the time intervals depending on the results. In addition to running laboratory tests, you can also use the "Total Count Tester" as a simple means of performing this test.

To order the motor total count tester, see "Spare parts and consumables" [→ 285].

#### IMPORTANT

##### Shelf life of the total count tester

The maximum shelf life of the total count tester is 1 year after the date of receipt.

The cardboard disk contains a dehydrated nutrient medium. It is activated by the sample and serves as a culture medium for a number of bacteria. The bacterial count provides information on the hygienic condition of the water.

Be careful not to touch the inside of the test container or the part of the tester to be immersed in the nutrient medium prior to incubation.

1. Allow water to run out of the Sprayvit M multifunctional syringe into the cuspidor bowl for about 1 minute.
2. Use the Sprayvit M multifunctional syringe to fill cold water into test container up to its upper mark.
3. To neutralize the disinfecting agent of the water sample, add approx. 1.5 g of fixing salt (sodium thiosulfate). Fixing salt can be obtained in pharmacies or from chemical dealers.

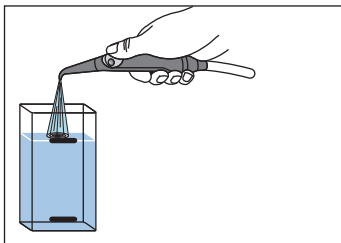

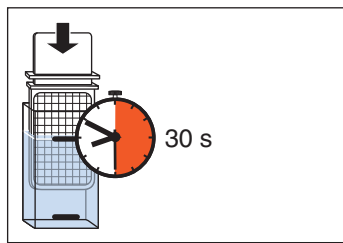

4. Immerse the tester in the filled container for 30 seconds.
  - ↳ The cardboard disk with the culture medium will now absorb 1 ml of the water sample.

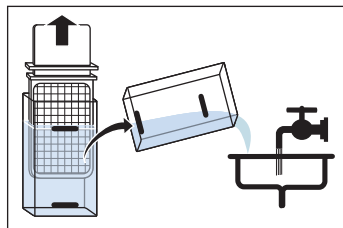

5. Remove the tester from the container. Shake out any excess water. Empty the tank.
6. Place the tester in the container for incubation either for two days at a room temperature of 20°C/68°F or for 24 hours at a temperature of 35°C/95°F.

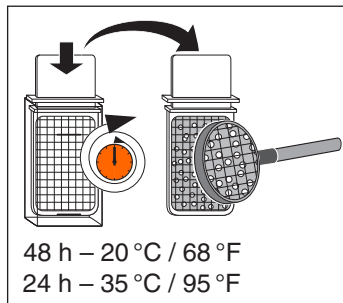

7. Count all bacterial colonies found on the surface of the tester.

If the bacterial count is well over 100, the water must be treated, see "Sanitization" [→ 264] and "Biofilm removal by the service technician" [→ 276].

#### 5.1.4 General handling instructions

The general reprocessing instructions generally apply to the treatment center provided there are no other product-specific reprocessing instructions in this operating manual. The manufacturer's instructions related to disinfectants must be observed (temperature, concentration, exposure times, etc.).

##### Manual cleaning

Manual cleaning is carried out with a clean, disinfected, soft brush or cloth, under good lighting (min. 500 lux) and color rendering index (min. 80 Ra) until no more dirt can be seen, for at least 10 seconds. Unless described otherwise, use clear water (< 38 °C, < 100 °F, at least drinking water quality) to clean superficial dirt.

##### Manual disinfection

The treatment center can be disinfected by wiping. Other disinfection methods such as spray disinfection, immersive bath, etc. cannot be used. Use a soft colorless cloth and disinfectant approved by Dentsply Sirona for disinfection. Use only disinfectants that comply with the requirements of your national authorities and whose bactericidal, fungicidal and virucidal properties have been tested and properly certified.



##### Machine cleaning and disinfection

Thermal disinfection at up to 93 °C in accordance with ISO 15883-1/-2 is possible for labeled components. Use cleaning and disinfection

equipment with a suitable cleaning agent. After reprocessing, inspect the components under good lighting (min. 500 lux) and color rendering index (min. 80 Ra) to ensure they are clean.

### Manual drying

No drying is required following wiping with disinfectants since surplus disinfectant evaporates. Surplus water from the cleaning process can be removed with a soft cloth.

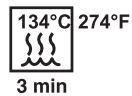

### Sterilization

Sterilization may be conducted for components that are marked accordingly. Steam sterilizers that fulfill the requirements of EN 13060, class B (e.g., DAC Premium / DAC Professional) are approved.

The sterilization must be completed with multiple vacuum fractionation (class B sterilizer). The process parameters can be found in the engraved characters on the relevant components and the instructions for use for these.

During the drying cycle, the sterilized parts must not exceed a temperature of 140 °C (284 °F).

## 5.1.5 Inspection, maintenance and testing

Unless otherwise specified in this operating manual, test all components for proper functioning on a regular basis and carry out a visual inspection for damage and wear. Exchange damaged components if necessary.

## 5.2 Surfaces

### 5.2.1 Clean/disinfect surfaces

The surfaces can be disinfected by wiping with surface disinfectants.

#### NOTE

**Drugs have a chemical reaction with the surface of the unit.**

Due to their high concentrations and the substances they contain, many drugs can dissolve, etch, bleach, or stain surfaces.

- Wipe any drug residues off the unit immediately with a moist, white cloth!

#### NOTE

**Liquids can enter the unit during cleaning or disinfection.**

Electrical components of the treatment center can be destroyed by liquids.

- Do not spray any liquids into the unit.
- To clean near openings, first spray the liquid onto a cleaning cloth. Then wipe over the unit with the cleaning cloth.

#### NOTE

**Disinfectants can dissolve dyes in cleaning clothes.**

The outer surface of the unit may then be discolored by the dye.

- Do not clean or disinfect the unit with colored cleaning cloths.
- Remove any dirt and disinfectant residues regularly using a mild commercial cleaning agent.

## 5.2.2 Disinfect the EasyTouch

The touchscreen and fixed keys of the dentist element, with the exception of the standby switch, can be deactivated for disinfection. This prevents the inadvertent triggering of unwanted functions.

### NOTE

#### Approved care, cleaning, and disinfecting agents

Use only care, cleaning, and disinfecting agents that have been approved by Dentsply Sirona, see "Care, cleaning, and disinfecting agents" [→ 204].

Clean



1. Actuate the *Clean* fixed key on the dentist element.
  - ↳ A display stating that the touchscreen and fixed keys are deactivated appears on the touchscreen. The standby switch is excluded from this.
2. Disinfect the EasyTouch user interface by means of wipe disinfection.
3. Press and hold the *Clean* fixed key on the dentist element (> 3 s) or press the pedal of the foot switch.
  - ↳ The touchscreen and fixed keys are now reactivated.



### 5.2.3 Disinfecting handles

#### NOTE

##### Approved care, cleaning, and disinfecting agents

Use only care, cleaning, and disinfecting agents that have been approved by Dentsply Sirona, see "Care, cleaning, and disinfecting agents" [→ 204].

The handles on the instrument holder of the dentist and assistant element can be wiped and thermally disinfected. They can be detached.

#### Sinius and Sinius TS dentist elements

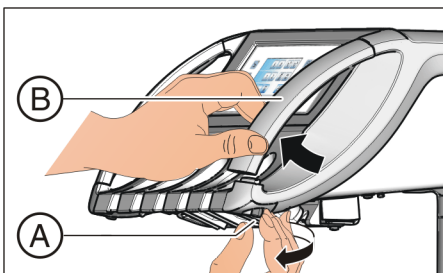

1. Loosen the screw **A**.  
↳ The handle **B** is unlocked.

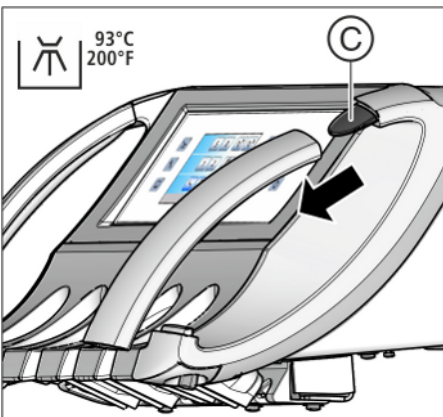

2. Slightly lift the handle **B** and pull it from guide bracket **C**.
3. Repeat this procedure for the opposite handle.

Proceed in reverse order when reattaching the handle.

#### Sinius CS dentist element

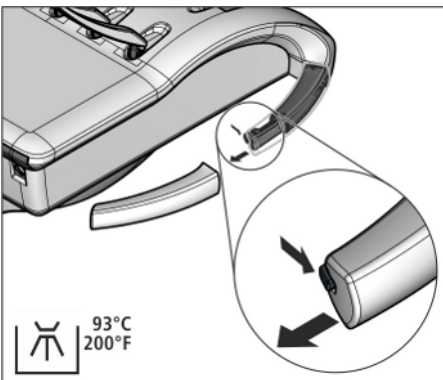

1. Press the button provided at the end of the handle.  
↳ This will release the locking mechanism and the handle can be detached.
2. Repeat this procedure for the opposite handle.

The handle locks in place independently when slid again.

### Assistance element

- Press the button provided at the end of the handle.
  - ↪ This will release the locking mechanism and the handle can be detached.

The handle locks in place independently when slid again.

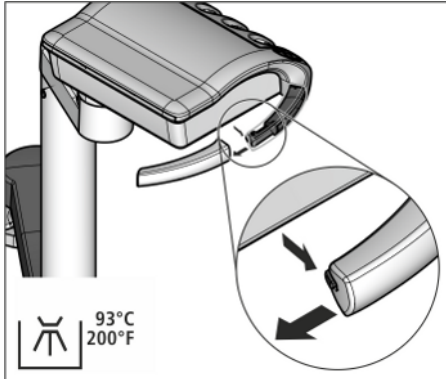

## 5.2.4 Disinfecting the tray

The tray can be removed to facilitate cleaning or thermal disinfection.

### NOTE

#### Approved care, cleaning, and disinfecting agents

Use only care, cleaning, and disinfecting agents that have been approved by Dentsply Sirona, see "Care, cleaning, and disinfecting agents" [→ 204].

### ⚠ CAUTION

**If the tray is not locked in place, it can disengage from the tray holder.**

- After installing the tray, make sure it is securely attached to the tray holder.

#### Tray on the support arm

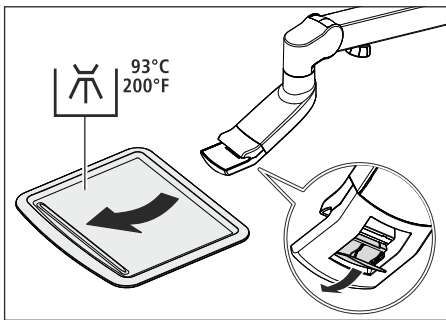

1. Hold the tray tightly.
2. Open the lock by swiveling the lever downwards.
3. Remove the tray.
4. Let the lever fall back into its original position.
5. If a cup holder is attached to the tray, it must be removed, see "Disinfecting the cup holder" [→ 212].
6. Thermally disinfect the tray.

To insert the tray, simply guide it into the mount. The mechanism locks automatically.

#### Tray on the Sinius CS and Sinius TS dentist element

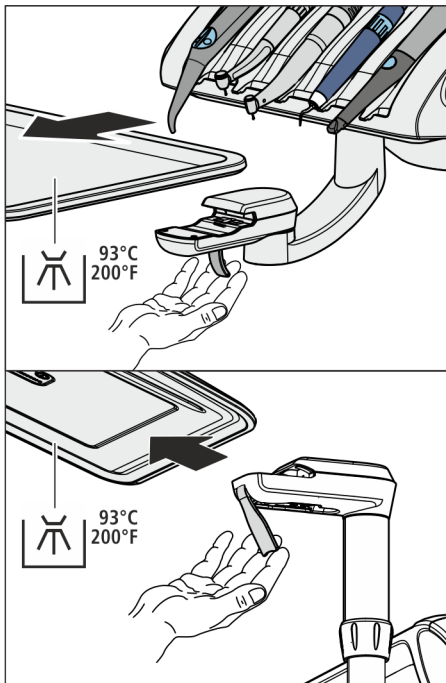

1. Hold the tray tightly.
2. Open the lock by swiveling the lever downwards.
3. Remove the tray.
4. Let the lever fall back into its original position.
5. If a cup holder is attached to the tray, it must be removed, see "Disinfecting the cup holder" [→ 212].
6. Thermally disinfect the tray.

To insert the tray, simply guide it into the mount. The mechanism locks automatically.

### 5.2.5 Disinfecting the cup holder

The cup holder can be wipe or thermally disinfected.

The disposable cup must be replaced after each patient.

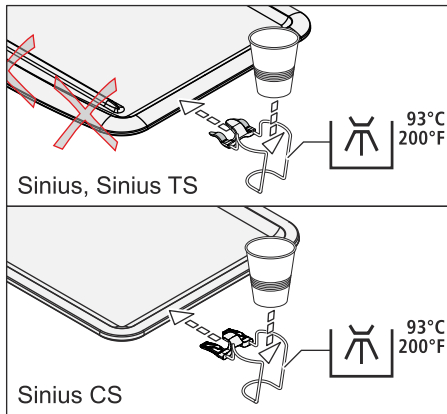

#### NOTE

##### Approved care, cleaning, and disinfecting agents

Use only care, cleaning, and disinfecting agents that have been approved by Dentsply Sirona, see "Care, cleaning, and disinfecting agents" [→ 204].

### 5.2.6 Care for, clean, and disinfect upholstery

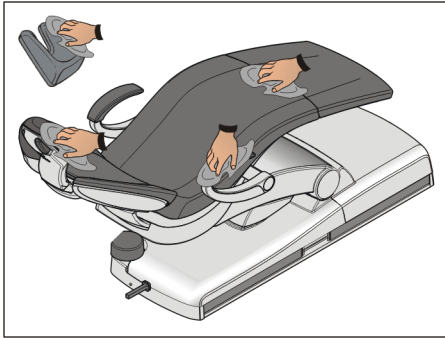

Special care, cleaning, and disinfecting agents are recommended by Dentsply Sirona for the care, cleaning, and disinfection of the upholstery.

#### NOTE

##### Approved care, cleaning, and disinfecting agents

Use only agents approved by Dentsply Sirona for the upholstery, see "Care, cleaning, and disinfecting agents" [→ 204]!

The upholstery of the patient chair and the headrest can be spray and wipe disinfected.

The armrests can also be spray and wipe disinfected using the recommended surface disinfectant. After use, wipe the chair down with an absorbent cloth so no disinfectant remains on the upholstery.

The imitation leather upholstery must be cared for and cleaned regularly (at least once a week).

#### NOTE

**Please note that the FD 360 cleaning and care agent for imitation leather from Dürr must not be used on the chrome-plated surfaces of the armrests or double articulating headrest.**

Otherwise, there is a risk of discoloration.

#### NOTE

**The special sponge included with FD 360 may not be used on lounge upholstery.**

Lounge upholstery could be damaged by the special foam.

**Tip:** The upholstery of the Hugo, Theo, Carl, and Paul dental working stool is identical to that of the patient chair. It can therefore be cleaned in the same way; refer to the instructions for use for the respective dentist stool.

### 5.2.7 Cleaning the bottom surface of the mount for the backrest component.

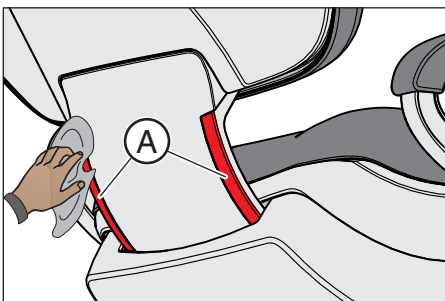

The bottom surface of the mount **A** must be cleaned regularly on both sides. This ensures that the backrest moves smoothly and easily.

- Clean the mount with a damp cloth.

## 5.2.8 Thermally disinfecting the instrument holder of the dentist element and sterilizing the silicone mat

### Sinus and Sinus TS dentist elements

The instrument holder can be removed for cleaning and thermal disinfection.

The removable silicone mat on the dentist element can be sterilized.

#### Removing the holder

1. Remove all instruments from the holder.
2. Swivel both of the levers **A** below the instrument holder to the rear.  
↳ The latch of the instrument holder is released.
3. Grasp underneath the instrument holder and raise it at the rear.  
↳ The instrument holder tilts to the front and can be removed from the dentist element in an upward direction.

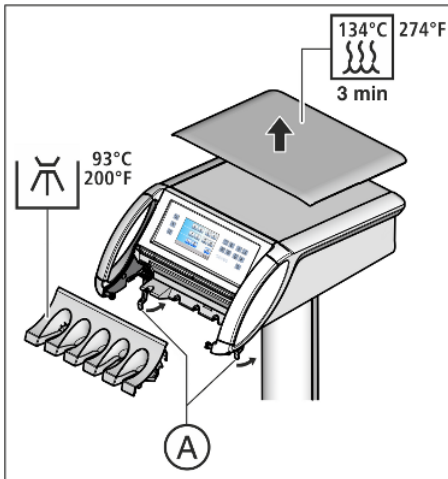

#### Inserting holder

- ✓ The levers **A** are swiveled to the rear.
1. Fit the front recesses **B** of the instrument holder onto the bolts in the dentist element.
  2. Gently press the instrument holder into the dentist element.
  3. Hold the instrument holder firmly and swivel both levers **A** toward the front.  
↳ The instrument holder is locked into the dentist element.

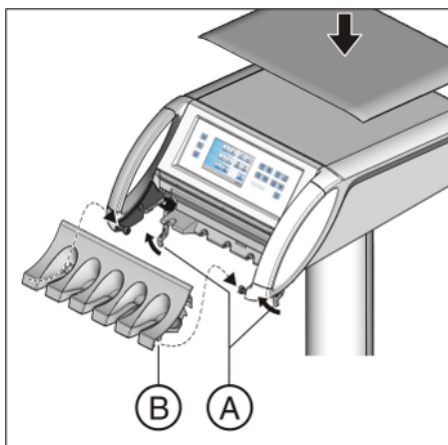

### Sinius CS dentist element

The instrument holder can be removed for cleaning and disinfection. It can be disinfected by spraying or wiping.

The removable silicone mat on the dentist element can be sterilized.

The instrument holder is fixed on the front edge with two internal clamps on the dentist element.

### Removing the holder

1. To do this, remove all instruments one after the other and allow them to hang down in front of the dentist element.
2. Lift the instrument holder by the front edge until the clamps are released and the holder can be removed.

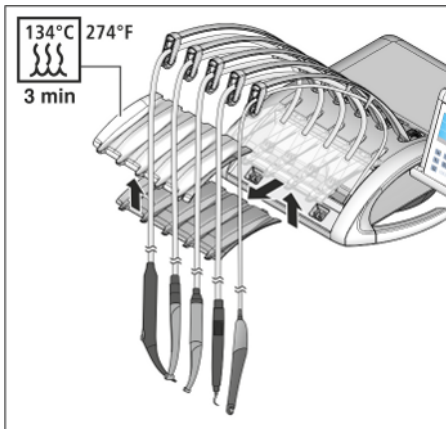

### Inserting holder

1. First insert the rear edge of the instrument holder into the groove on the dentist element. Then push the holder forward and down until it locks into place.
2. Place the instruments in their holders. Make sure that the instrument hoses are once again located in the guide rollers of the swivel arm.

### Ball stopper (for Sinius and Sinius TS dentist elements)

If a ball stopper is inserted in an unused instrument holder, it can simply be pushed out of the holder from the rear to facilitate cleaning or thermal disinfection.

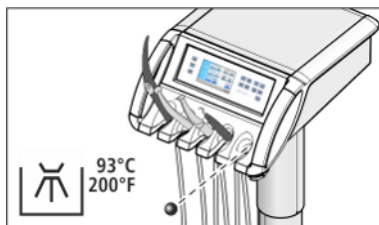

### 5.2.9 Thermally disinfecting the instrument holder of the assistant element and sterilizing the silicone mat

The instrument holder can be removed for cleaning and thermal disinfection.

The removable silicone mat on the assistant element can be sterilized.

#### Removing the instrument holder

1. Remove all instruments from the instrument holder.
2. Loosen the screws **A** located below the assistant element.

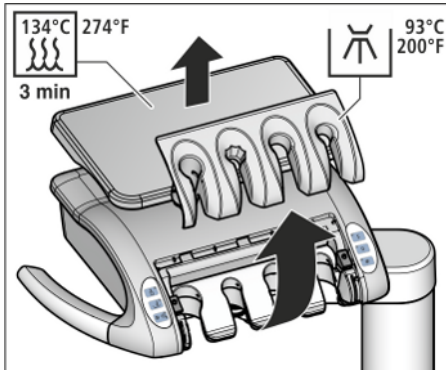
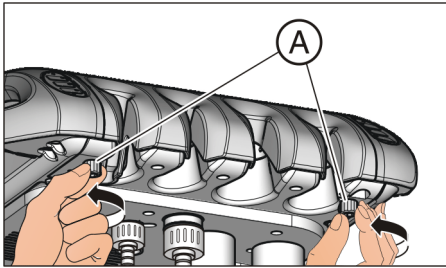

3. Remove the instrument holder.

#### NOTE

**The instrument holder must be fixed in the thermal disinfectant.**

Abrasion and scuffing may result if the holder is not fixed securely.

- > Position the instrument holder with the top facing upward in the thermal disinfectant tray. Fix in place to prevent the instrument holder from slipping out of position.

#### Inserting the instrument holder

1. First insert the rear edge of the instrument holder into the groove on the assistant element. Then fold the holder forward and downward.
2. Fasten the holder again.

### 5.2.10 Clean the foot switch

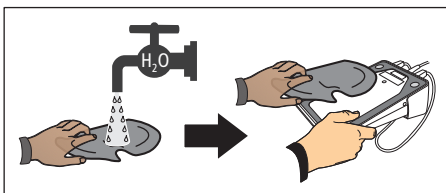

Regular cleaning of the foot control improves its stability.

- > Clean the anti-slip coating on bottom plate with a moist cloth (water).



## 5.3 Instruments and instrument hoses

### 5.3.1 Rinse water paths

Microorganisms can grow in the water paths of the treatment center. Use a large amount of water for rinsing the lines prior to starting patient appointments.

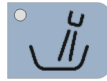

- > Flush the cuspidor for at least one minute.

### 5.3.2 Purge water paths (purge function)

To reduce the amount of germs, the water paths of the water-carrying instruments of the dentist element and the Sprayvit M multifunctional syringe of the dentist and assistant element are purged with water. Purging (Purge function)

For the purge function, individual instruments are removed from the holder and held over the cuspidor for purging. If your treatment center is not equipped with a cuspidor, hold the instruments over a watertight container with sufficient capacity. The water paths of all removed instruments are then purged simultaneously. **Press the water key of the Sprayvit M unit for purging.**

It is also possible to purge the water paths automatically, see "Automatically purge water paths (AutoPurge function)" [→ 220].

#### Preparation

The following preparations should be made before you begin to purge the water paths.

1. If your treatment center is equipped with a cuspidor, activate the cuspidor flushing for at least one minute. This flushes the water paths.
2. Set all of the instruments to be purged to their maximum water flow rate.
3. Put all instruments in their holders.

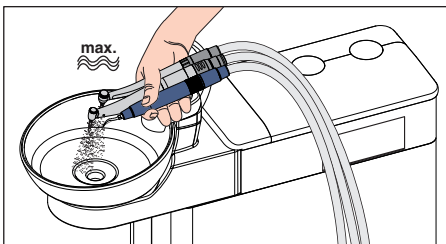

#### Opening the purging dialog

- ✓ The *Start dialog* is displayed on the touchscreen.

  1. In the *Start dialog standard version*: Touch the *Sub-dialog* key.  
In the *Start dialog simplified version*: Press the *Chair* dialog change key.





↳ The *Start* sub-dialog is displayed.



2. Touch the *Purge function* key.



↳ The *Purge* screen is displayed on the touchscreen.



### Setting the purge time and starting the purge function

The purge time of the removed instruments can be set between 20 and 180 seconds.

- ✓ The *Purge* dialog is displayed on the touchscreen.
- 1. Use the – and + keys to set the purging time.
- 2. Touch the *Start* key.

Please note that changes made during the purging process take effect only after the next purge process is started.



### Error message: Refill water (only for self-sufficient water supply)

If the *Refill water* display appears after the purge function has been started, there is not sufficient water in the disinfectant tank of the water unit to purge the water paths. The purge function cannot be started with insufficient water.

- > Mix distilled water with the agent for disinfecting the water paths in a ratio of 100:1 (1 liter of water, 10 ml of the agent) and fill this into the disinfectant tank of the water unit. For more information, please refer to the section "Self-sufficient water supply" [→ 162].
- ↳ When sufficient water has been refilled, the purge program continues.

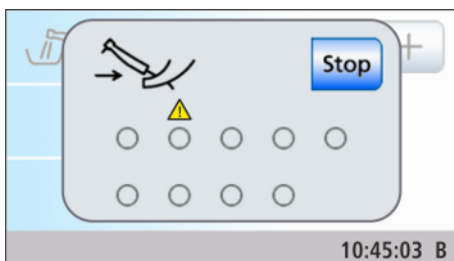

### Error message: Deposit instruments

If the *Deposit instruments* display appears after the purge function has been started, the treatment center has detected that not all of the instruments have been placed in their holders.

- > Check the seating of the instruments in the holders marked with a warning triangle on the touchscreen.
- ↳ When all of the instruments have been put in the holders, the purge program will continue.

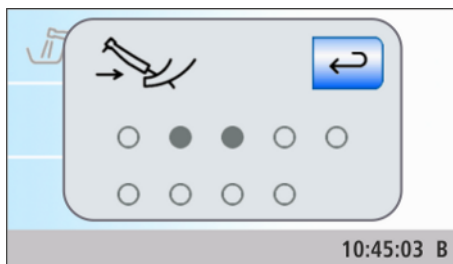
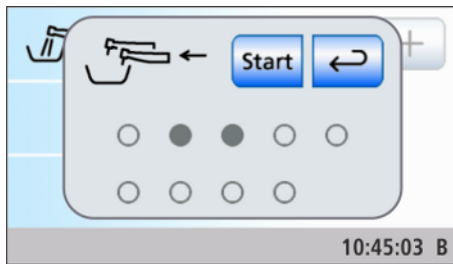

### Purging water paths

- ✓ The *Remove instruments* display appears on the touchscreen.
- 1. Remove the instruments to be purged from the holder. With the Sinius CS: Move the swivel arm of the instruments to be purged into the operating position so that the weight of the instrument hoses keeps them in this position.
  - ↳ If an instrument has been removed, this is displayed by a solid gray circle on the touchscreen.
- 2. Hold the instruments over the cuspidor or over a watertight container with sufficient capacity. Then press the *Start* key on the dentist element. **Press the water key on the Sprayvit M unit for purging.**
  - ↳ The removed instruments are purged with water for the duration of the set purging time. The elapsed purge time is displayed by a progress bar on the touchscreen. When the purge time has elapsed, the *Set instruments down* display appears.
- 3. Place the removed instruments back in their holders. All instruments not deposited are marked with a solid gray circle on the touchscreen.
  - ↳ When all of the instruments have been deposited, the *Deposit instruments* display disappears.
  - ↳ The water path purging procedure is finished. The treatment center is again ready for operation.

### Canceling the purge function

In the case of the error message *Deposit instruments* or during purging, the purge function can be canceled.

- > Touch the *Stop* key on the touchscreen.



### 5.3.3 Automatically purge water paths (autopurge function)

The autopurge function enables automatic purging of all water-carrying instruments in the dentist element, the Sprayvit M multifunctional syringe in the dentist and assistant elements, and the tumbler filling unit.

All of the instruments inserted in the water unit are purged when the autopurge function is activated. If the instruments remain in the water unit after the treatment center is switched off, the purging process will automatically be started again the next time the treatment center is switched on.

Execute the AutoPurge function:

- Before starting work
- At the end of the work day

When the treatment center is switched to stand-alone water supply mode, the AutoPurge function is no longer available (key hidden). It is still possible to purge individual instruments; see "Purging water lines (purge function)" [-> 217].

#### Preparation

The following preparations must be made before you start purging the water lines:

1. If your treatment center is equipped with a cuspidor, activate the cuspidor flushing for at least one minute. This flushes the water paths.
2. Set all burr drives and the SiroSonic TL scaler to the maximum water flow rate.
3. Put all instruments in their holders.
4. Do **not** remove the tumbler holder from the cuspidor. Place the empty tumbler under the tumbler outlet.

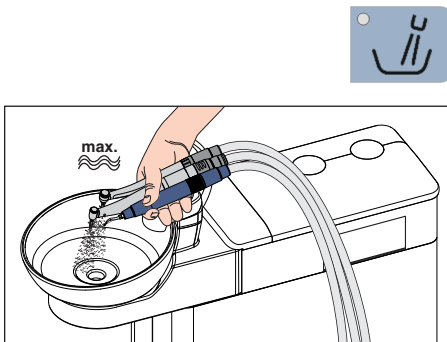

#### Opening the AutoPurge dialog

✓ The *start dialog* is displayed on the touchscreen.

1. In the *start dialog standard version*: Touch the *Sub-dialog* key.  
In the *start dialog simplified version*: Press the *Chair* dialog change key.

↪ The *Start* sub-dialog is displayed.





2. Touch the *AutoPurge* function key.



↪ The *AutoPurge* dialog is displayed on the touchscreen.

### Setting the instrument purge time and starting the AutoPurge function

The purging time of the instruments may be set between 60 and 180 seconds.

✓ The *AutoPurge* dialog is displayed on the touchscreen.

1. Use the – and + keys to set the purging time.
2. Touch the *Start* key.



### Error message: Deposit instruments

If *Deposit instruments* is displayed after the AutoPurge function has been started, the treatment center has detected that not all of the instruments have been placed in their holders.

- Check the seating of the instruments in the holders marked with a warning triangle on the touchscreen.
  - ↪ The autopurge program will continue when all instruments have been deposited in the holder.

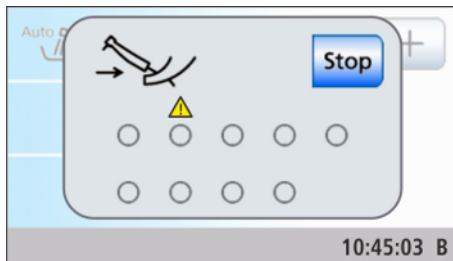

### Insert water-carrying instruments and suction hoses into the water unit

The water unit has integrated sanitization adapters for water-carrying instruments and adapters for suction hoses. They enable all instruments to be purged with water. For this purpose, water-carrying instruments must be inserted into the sanitization adapters and the suction hoses into the adapters for suction hose cleaning.

✓ The *Insert instruments in water unit* display appears on the touchscreen.

1. Remove the Sprayvit M sleeves from the valve bodies, the straight and contra-angle handpieces from the water-carrying instruments, and the suction tips from the suction hoses.

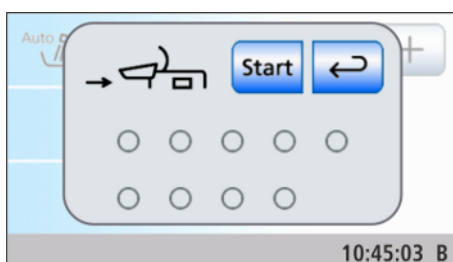

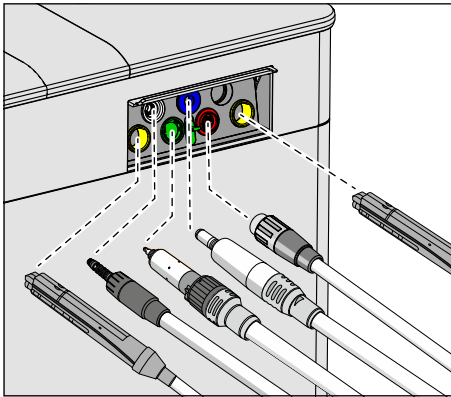

2. Dentist element side: Insert the couplings of all water-carrying treatment instruments into the sanitization adapters in the water unit (for Sprayvit M: valve lever in up position, locking knob in the down position).  
Additionally for Sinus CS: Move the swivel arm of the instruments to be purged into operating position so that the weight of the instrument hoses keeps them in this position.

#### IMPORTANT

##### Colors of the sanitization adapters

The sanitization adapters for the instrument couplings are color coded:

Yellow on left = Sprayvit M of the assistant element

Yellow on right = Sprayvit M of the dentist element

White = turbine

Green = BL motor

Blue = BL ISO E/C motor (ISO interface)

Red = SiroSonic TL scaler

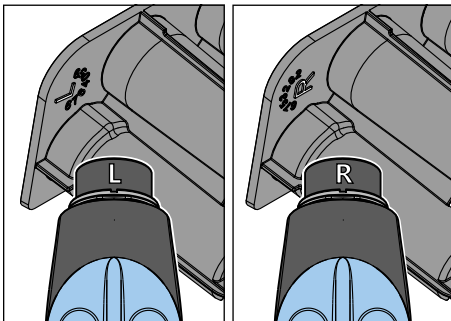

#### IMPORTANT

##### Water button of the Sprayvit M

Depending on the position of the Sprayvit M water button, the removable sanitization cartridge is marked on the back. When the nozzle is taken from the holder, this mark can also be seen on the Sprayvit M. If the water button is on the right, the marking is an "R", for the Sprayvit M with water button on the left "L". The marking on the removable sanitization cartridge must match that on the Sprayvit M.

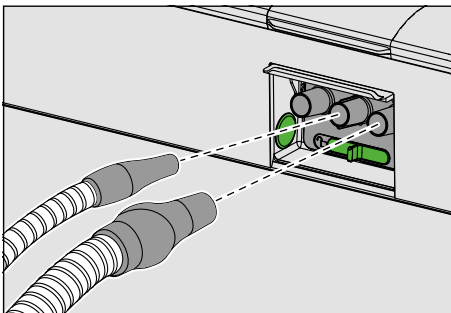

3. Assistant element side: Attach the suction hoses.

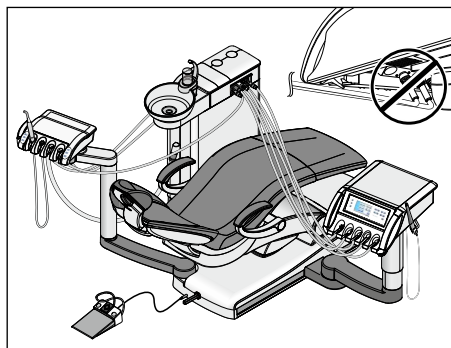

#### IMPORTANT

##### Pinching the instrument hoses

Be careful not to pinch the instrument hoses when inserting the instruments.

If the hoses are pinched, the water flow will be obstructed during purging.

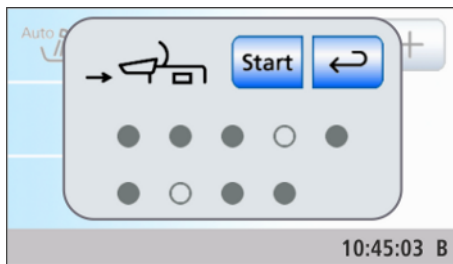

⇒ All water-carrying instruments are inserted into the sanitization adapters. The suction hoses are inserted in the adapters for suction hose cleaning.

4. Touch the *Start* key on the touchscreen.

⇒ The treatment center checks whether there is water flow through the instruments. This will take a moment.

#### Error message: No water flow

If the treatment center detects no water flow through an instrument, you can try to restore water flow. If this is not possible, the affected instrument can be excluded from the purging process.

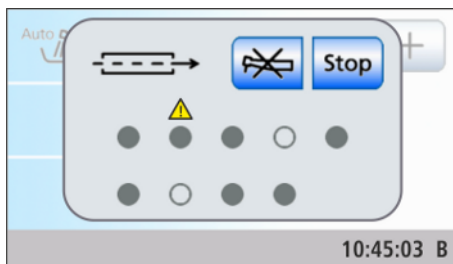

1. Check the water flow through the instruments in the instrument positions marked with a warning triangle on the touchscreen. Set the instruments to maximum water flow. Keep the instruments plugged into the water unit.

⇒ If the treatment center detects the water flow, the warning triangle will disappear. If water flow is detected for all instruments, the AutoPurge program automatically continues.

2. If you want to exclude the instruments concerned from purging, touch the *Exclude instrument* key.

⇒ The AutoPurge program continues. The water paths affected are not included in the purging process.

#### Purging water lines

The removed instruments are purged with water for the duration of the set AutoPurge time. Afterwards, the tumbler filler is purged and the suction hoses are cleaned. The progress bar displayed on the touchscreen refers to the entire AutoPurge program, not to the set instrument purge time.

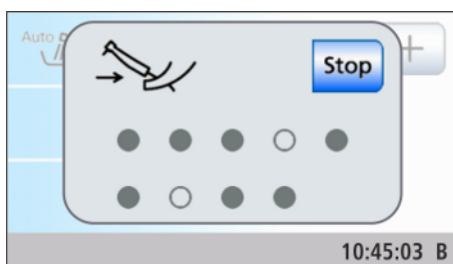

Following the purging process and suction hose cleaning, the display *Deposit instruments* appears.

### Displays if the purging process is not completed

The AutoPurge program can determine whether the purge process for all instruments and the tumbler filling has been completed. Errors that occurred during flushing are displayed on the touchscreen using a warning triangle.

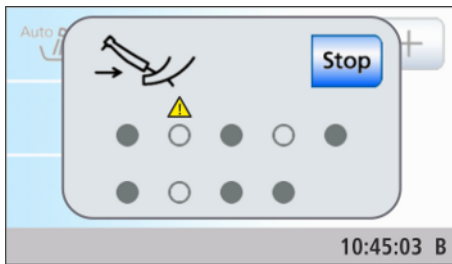

### Leave the AutoPurge function active for the next working day or stop it

There are now two options for continuing:

- **Leave the instruments in the water unit**

The AutoPurge function remains activated provided the *Stop* or *Back* keys are not pressed.

The instruments remain in the water unit and the treatment center can be switched off. Unless this function is deselected, the treatment center automatically shuts down in the evening after autopurge. On the next day, the autopurge function is automatically performed again on all of the instruments remaining in the water unit as well as on the tumbler filling unit and the suction hoses are cleaned again immediately after the treatment center is switched on.

Then you can prepare the treatment center for daily practice operation.

If the treatment center is out of operation over a prolonged period of time, you can briefly switch it on every day and then switch it off again when the flushing process is finished. This ensures that the number of microorganisms in the water lines will not increase excessively. Empty the rinsing tumbler after each flushing process and return the empty tumbler below the tumbler outlet.

If any instruments are removed from the water unit or new instruments are connected to the treatment center while the latter is switched off, they must be plugged into the sanitization adapters of the water unit or returned to the instrument holder again before switching the treatment center back on.

- **Deposit instruments**

The AutoPurge function is completed.

➤ Remove the instruments from the water unit and place them back in their holders.

↪ When all of the instruments have been deposited, the *Deposit instruments* display disappears.

↪ The AutoPurge procedure is finished. The treatment center is again ready for operation and can be prepared for the working day.

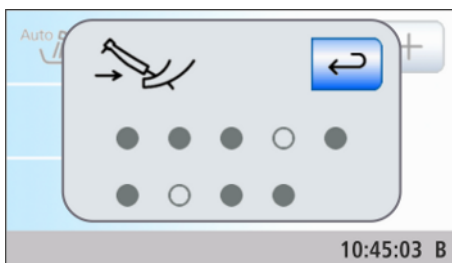



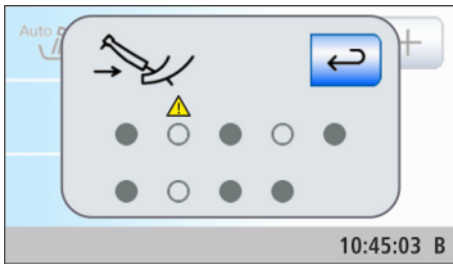

If individual water-carrying instruments are not flushed, this is displayed on the touchscreen by a warning triangle.



In this case the *Back* key must be activated to end the AutoPurge function.

#### Canceling the AutoPurge function



If the error message *Deposit instruments* appears at the end of the flow rate check or during purging, the AutoPurge function can be canceled.

> Touch the *Stop* key on the touchscreen.

## 5.3.4 Lubricate, disinfect/sterilize the treatment instruments

### 5.3.4.1 Treatment instruments with separate instructions for use

The procedures required for the following treatment instruments are described in the following separate instructions for use:

- Straight and contra-angle handpieces in various versions
- Turbines
- SiroSonic TL ultrasonic handpiece

### 5.3.4.2 Lubricate, disinfect/sterilize the Sprayvit M multifunctional syringe

#### NOTE

##### Approved care, cleaning, and disinfecting agents

Use only care, cleaning, and disinfecting agents that have been approved by Dentsply Sirona, see "Care, cleaning, and disinfecting agents" [→ 204]!

All disinfectants must be approved in your country and have proven bactericidal, fungicidal and virucidal properties. Use only disinfectants with no protein-fixing properties.

Do **not** use agents that are strongly acidic (pH < 5), alkaline (pH > 9) or contain a lot of chlorine.

#### NOTE

**Never** clean in an ultrasonic bath!

**Never** immerse in disinfectants!

#### After each treatment session

#### NOTE

Reprocess immediately, or at the latest, one hour after treatment.

- ✓ Wear appropriate protective clothing.
1. Remove any residue, e.g., from impression material or caustic chemicals, immediately.
  2. Purge the water and air channels on the treatment center for 30 seconds.
  3. Predisinfect directly at the treatment center [→ 226].
  4. Remove the nozzle and the housing [→ 101].
  5. Transport the nozzle and housing to the hygiene room in a suitable transport container.
  6. Perform automatic reprocessing [→ 227]. Manual reprocessing [→ 228] is possible in exceptional cases if national/local regulations are followed.
  7. Sterilize the housing, keyboard and nozzle [→ 228].

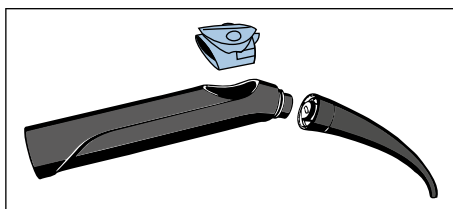

#### Conduct pre-disinfection

- ✓ Wear appropriate protective clothing.
  - ✓ All disinfectants must be approved in your country and have proven bactericidal, fungicidal and virucidal properties. Use only disinfectants with **no** protein-fixing properties.
1. Wipe the surface with disinfectant cloths.

2. Wipe the disinfectant off with a cloth.
  - ↳ For further reprocessing, the Sprayvit M should be dry and free of residue.

### Automated cleaning and disinfecting

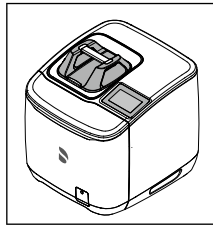

We recommend using the **Dentsply Sirona DAC Universal** for automated cleaning and disinfection (inside and outside) of the nozzles.

For further details, please refer to the instructions for use supplied with the unit.

#### NOTE

The housing and keyboard are **not** suitable for reprocessing in the Dentsply Sirona DAC Universal.

- ✓ The nozzle is reprocessed using the DAC Universal.
1. Check whether the nozzle is clean after reprocessing under good lighting (min. 500 lux) and color rendering index (min. 80 Ra).
  2. If they are still dirty, repeat the process.
    - ↳ For further reprocessing, the nozzle should be dry and free of residue.
  3. If necessary, pack the housing, keyboard and nozzle in packaging suitable for sterilization and storage, e.g., soft packaging (paper/film) or a container in accordance with ISO 11607.
  4. Perform sterilization [-> 228].

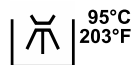

The housing, keyboard and nozzle can also be cleaned and disinfected in suitable **cleaning and disinfection equipment**. The cleaning and disinfection equipment used must comply with ISO 15883-1/-2 and be approved by its manufacturer for the cleaning and disinfection of dental instruments (e.g., 95°C (203 °F) and 10 min holding time).

#### IMPORTANT

Use suitable adapters for automated reprocessing in a washer-disinfector. For the nozzle, we recommend the A865 adapter for Miele washer-disinfectors.

For further details, please refer to the instructions for use supplied with the respective unit.

- ✓ The housing, keyboard and nozzle are reprocessed with a cleaning and disinfection device.
1. Check whether the housing, keyboard and nozzle are clean after reprocessing under good lighting (min. 500 lux) and color rendering index (min. 80 Ra).
  2. If they are still dirty, repeat the process.
    - ↳ For further reprocessing, the housing, keyboard and nozzle should be dry and free of residue.
  3. Blow the nozzle with 2.5 - 3 bar until no more moisture exits, but at least 10 seconds.
  4. If necessary, pack the housing, keyboard and nozzle in packaging suitable for sterilization and storage, e.g., soft packaging (paper/film) or a container in accordance with ISO 11607.
  5. Perform sterilization [-> 228].

### Manual cleaning and disinfection

Manual reprocessing is possible in exceptional cases if the national/local regulations are followed. The national/local regulations must be checked in advance.

#### NOTE

The valve body of Sprayvit M is **not** suitable for cleaning or disinfection.

- ✓ All disinfectants must be approved in your country and have proven bactericidal, fungicidal and virucidal properties. Use only disinfectants with **no** protein-fixing properties.
- 1. Brush the housing, keyboard and nozzle under running water (< 38°C, < 100°F, at least drinking water quality) and good lighting (min. 500 lux) and color rendering index (min. 80 Ra) until no more dirt can be seen, for at least 10 seconds.
- 2. Conduct thermal disinfection or unwrapped steam sterilization.
- 3. If necessary, pack the housing, keyboard and nozzle in packaging suitable for sterilization and storage, e.g., soft packaging (paper/film) or a container in accordance with ISO 11607.
- 4. Perform sterilization [→ 228].

### Maintaining the cooling nozzle outlet

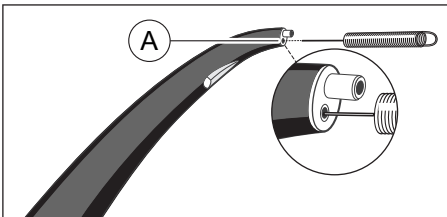

#### CAUTION

The media temperatures may become too high if the water path in the nozzle is clogged. Risk of burns!  
> Clean the water path **A** regularly.

- ✓ The nozzle is removed.
- > Insert the cleaning wire provided through the water path in the nozzle to clean it.

### Cleaning the light guide surfaces

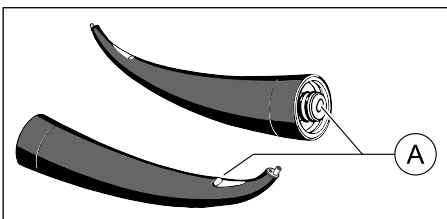

1. In order to avoid scratching the surfaces **A**, blow off any dirt particles with air.
2. Wipe the surfaces with a Q-tip or a soft cloth and alcohol.

### Sterilizing

Intervals:

- Prior to initial operation
- Prior each subsequent use

Procedure:

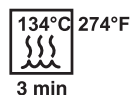

#### NOTE

The valve body is not suitable for use in the steam sterilizer.

- ✓ The housing, keyboard and nozzle are cleaned and disinfected.
- Sterilize the housing, keyboard and nozzle in the steam sterilizer with saturated water vapor.

Overpressure: 2.04 bar (29.59 psi)  
Temperature: 134°C (274°F)  
Holding time: 3 min

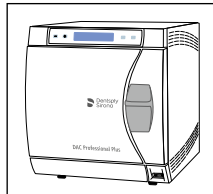

Steam sterilizers that fulfill the requirements of either EN 13060, class B (for example, DAC Premium / DAC Professional) or EN 13060, class S and are suitable for the sterilization of multi-functional syringes are approved.

Please observe the instructions for use for the sterilizer.

#### NOTE

Do not exceed 140°C (284°F), even during the drying phase.

Please observe the instructions for use for the sterilizer.

After sterilizing:

1. Remove the housing, keyboard and nozzle from the steam sterilizer immediately.

#### ⚠ CAUTION

These parts are hot. Risk of burns!

#### NOTE

Do **not** try to accelerate the cool-down process by placing the parts in cold water. This will damage the parts!

2. Store all components so that they are protected against contamination.
3. Sterilize again once the storage period has elapsed.

#### 5.3.4.3 Check the flow rate on the Sprayvit M multifunctional syringe

If the flow rate is less than 135 ml/min with the water button fully actuated, there is a risk of excessively hot water being emitted.

#### ⚠ CAUTION

**If the flow rate is insufficient, hot water may be emitted by the Sprayvit M.**

The patient could thus be scalded.

- Check the water flow rate prior to use.
- Clean the nozzle if required, see "Maintaining the cooling nozzle outlet" [→ 228].

#### IMPORTANT

##### **Air outlet during hose change**

If the Sprayvit M is removed from the instrument hose while the treatment center is in use, air will escape from the hose coupling. You should therefore switch off the treatment center before changing a hose.

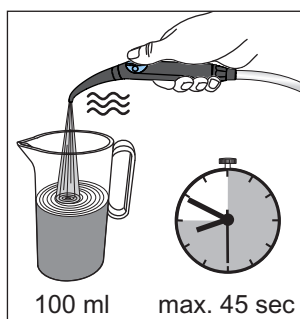

Perform the following measurement to exclude a patient risk.

- > Fill a measuring cup up to the 100 ml mark with the water button fully actuated while measuring the required filling time.
  - ↳ The filling time must not exceed 45 seconds.

If the indicated water level is not reached within the filling time of 45 seconds, clean the nozzle, see "Maintaining the cooling nozzle outlet" [→ 228] or have the treatment unit checked by a service technician.

#### 5.3.4.4 Disinfecting/sterilizing motors and adapters

##### NOTE

###### Approved care, cleaning, and disinfecting agents

Use only care, cleaning, and disinfecting agents that have been approved by Dentsply Sirona, see "Care, cleaning, and disinfecting agents" [→ 204]!

All disinfectants must be approved in your country and have proven bactericidal, fungicidal and virucidal properties. Use only disinfectants with no protein-fixing properties.

Do **not** use agents that are strongly acidic (pH < 5), alkaline (pH > 9) or contain a lot of chlorine.

##### NOTE

**Never** clean in an ultrasonic bath!

**Never** immerse in disinfectants!

##### NOTE

###### Never lubricate the motors!

- > Remove the handpieces from the motors at the end of the working day so that no oil can run in overnight.

#### After each treatment session

##### NOTE

Reprocess immediately, or at the latest, one hour after treatment.

- ✓ Wear appropriate protective clothing.
- 1. Purge the water and air channels on the treatment center for 30 seconds.
- 2. Remove the instrument [→ 110].
- 3. Predisinfect directly at the treatment center [→ 231].

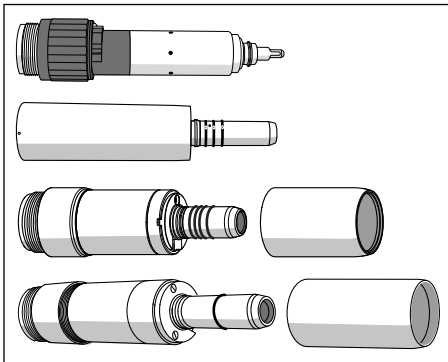

4. Remove the adapter/motor [→ 109].
5. Transport the motor/adapter to the hygiene room in a suitable transport container.
6. Perform automatic reprocessing of the adapter [→ 231]. Manual reprocessing [→ 232] is possible in exceptional cases if national/local regulations are followed.
7. Conduct manual conditioning of the motor following national/local regulations [→ 232].
8. Sterilize the motor, adapter, and accessories [→ 232].

### Conduct pre-disinfection

- ✓ Wear appropriate protective clothing.
  - ✓ All disinfectants must be approved in your country and have proven bactericidal, fungicidal and virucidal properties. Use only disinfectants with **no** protein-fixing properties.
  - ✓ Use disinfectants and other agents that contain **no** corrosive components such as chloride.
1. Wipe the surface with disinfectant cloths.
  2. Wipe the disinfectant off with a cloth.
    - ↳ For further reprocessing, the motor/adapter should be dry and free of residue.

### Automated cleaning and disinfecting

Apply the following steps for the adapter only.

#### NOTE

Do **not** clean the motors automatically.

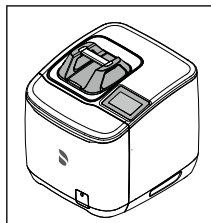

We recommend using **Dentsply Sirona DAC Universal** for automated cleaning, disinfection, and care.

For further details, please refer to the instructions for use supplied with the unit.

- ✓ The adapter is reprocessed using the DAC Universal.
1. Check whether the adapter is clean after reprocessing under good lighting (min. 500 lux) and color rendering index (min. 80 Ra).
  2. If they are still dirty, repeat the process.
    - ↳ For further reprocessing, the adapter should be dry and free of residue.
  3. If necessary, pack the adapter in packaging suitable for sterilization and storage, e.g., soft packaging (paper/film) or a container in accordance with ISO 11607.
  4. Perform sterilization [→ 232].

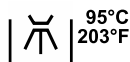

The adapter can also be cleaned and disinfected in suitable **cleaning and disinfection equipment**. The cleaning and disinfection equipment used must comply with ISO 15883-1/-2 and be approved by its

manufacturer for the cleaning and disinfection of dental instruments (e.g., 95°C (203 °F) and 10 min holding time).

For further details, please refer to the instructions for use supplied with the respective unit.

- ✓ The adapter is reprocessed with a cleaning and disinfection device.
- 1. Check whether the adapter is clean after reprocessing under good lighting (min. 500 lux) and color rendering index (min. 80 Ra).
- 2. If they are still dirty, repeat the process.
  - ↳ For further reprocessing, the adapter should be dry and free of residue.
- 3. If necessary, pack the adapter in packaging suitable for sterilization and storage, e.g., soft packaging (paper/film) or a container in accordance with ISO 11607.
- 4. Perform sterilization [→ 232].

### Manual cleaning and disinfection

Manual reprocessing is possible in exceptional cases if the national/local regulations are followed. The national/local regulations must be checked in advance.

- ✓ All disinfectants must be approved in your country and have proven bactericidal, fungicidal and virucidal properties. Use only disinfectants with **no** protein-fixing properties.
- ✓ Use disinfectants and other agents that contain **no** corrosive components such as chloride.
- 1. Moisten a clean, lint-free cloth with disinfectant.
- 2. Wipe the motor/adapter with the moist cloth. When doing so, also wipe any hard-to-reach places.
- 3. Observe the application time for the disinfectant.
- 4. Wipe the motor/adapter dry.
  - ↳ The motor/adapter is disinfected and clean.
- 5. When the motor/adapter is dirty, repeat the cleaning process.

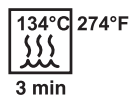
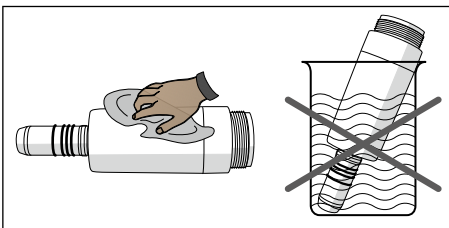

### Sterilizing

- ✓ The motor/adapter is cleaned and disinfected.
- ✓ The motor sleeve is unscrewed from the BL ISO E/C and BL Implant motor.
- ✓ If necessary, the adapter, motor and motor sleeve can be packed in packaging suitable for sterilization and storage, e.g., soft packaging (paper/film) or a container in accordance with ISO 11607.
- Sterilize the adapter, motor and motor sleeve in the steam sterilizer with saturated water vapor.

Overpressure: 2.04 bar (29.59 psi)

Temperature: 134°C (274°F)

Holding time: 3 min



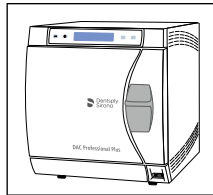

Steam sterilizers that fulfill the requirements of either EN 13060, class B (for example, DAC Premium / DAC Professional) or EN 13060, class S and are suitable for the sterilization of motors are approved.

#### NOTE

Do not exceed 140°C (284°F), even during the drying phase.

Please observe the instructions for use for the sterilizer.

After sterilizing:

1. Remove the adapter, motor and motor sleeve from the steam sterilizer immediately.

#### ⚠ CAUTION

The adapter, motor and motor sleeve are hot. Risk of burns!

#### NOTE

Do **not** try to accelerate the cool-down process by placing the parts in cold water. This will damage the parts!

2. Store all motors/adapters so that they are protected from contamination.
3. Sterilize again once the storage period has elapsed.

Sterilize regularly and have the motors serviced after approx. 2 years in a workshop authorized by Dentsply Sirona.

#### 5.3.4.5 Clean and disinfect/sterilize the components of the ApexLocator

#### NOTE

##### Approved care, cleaning, and disinfecting agents

Use only care, cleaning, and disinfecting agents that have been approved by Dentsply Sirona, see "Care, cleaning, and disinfecting agents" [→ 204].

- > Disconnect the mucosal electrode from the connection cable.

The metal hook and the connection cable can be sterilized.

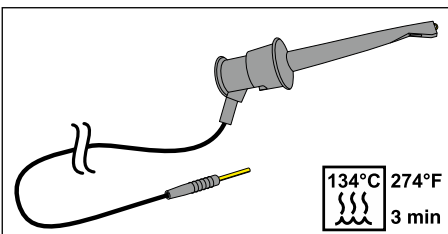
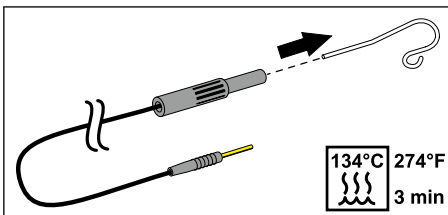

The file clamp for manual measurement can be sterilized with the connection cable.

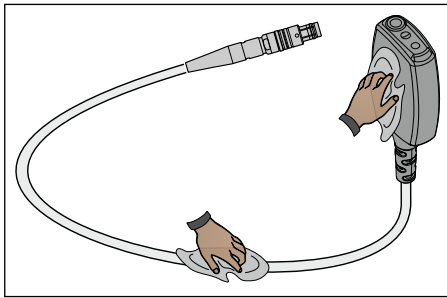

The apex adapter and its connection cable can be disinfected by wiping.

**IMPORTANT**

To guarantee conductivity, no disinfectant must be allowed to penetrate the electrical contacts.

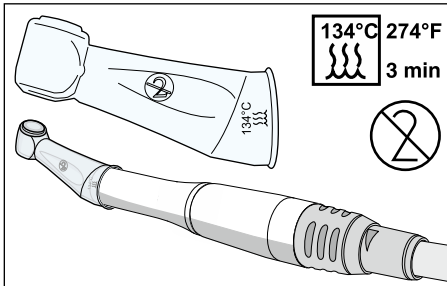

The silicone insulation sleeve is a disposable item. It must be changed after each patient. The silicone insulation sleeve must be sterilized prior to initial use.

To reorder the silicone isolation sleeve, see "Spare parts and consumables" [→ 285].

Sterilize the root canal files according to the manufacturer's instructions.

5.3.4.6

**Disinfecting/sterilizing Mini L.E.D. curing light**

**NOTE**

**Approved care, cleaning, and disinfecting agents**

Use only care, cleaning, and disinfecting agents that have been approved by Dentsply Sirona, see "Care, cleaning, and disinfecting agents" [→ 204].

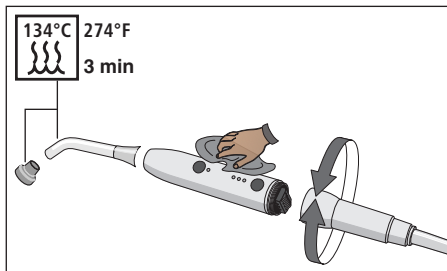

1. Remove the connection cable of the Mini L.E.D. by turning the handpiece.
2. Pull out the light guide and remove the glare shield.
3. Sterilize the light guide and the glare shield at 134° C, 2 bar for 3 min.
4. Disinfect the handpiece of the Mini L.E.D.
5. Screw the sterilized light guide and glare shield back onto the Mini L.E.D.
6. Reconnect the handpiece of the Mini L.E.D. to the connecting cable.

The following points should also be observed when operating the Mini L.E.D.:

- Always use the glare shield to protect your eyes.
- Check the light guide after each use. Make sure that the light guide is in perfect condition.
- There should be no traces of composite material on the light guide. Immediately remove any residue.
- If you find any damage, replace the light guide, since damage will impair its performance considerably.

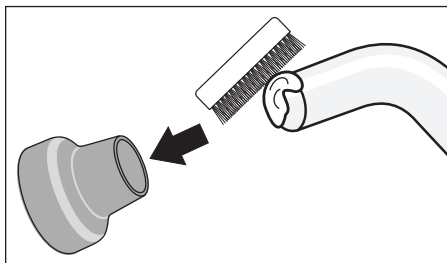

#### 5.3.4.7 Cleaning/disinfecting the SiroCam AF / AF+ intraoral camera

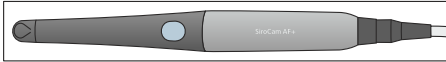

The shape of the SiroCam AF / AF+ intraoral camera complies with hygienic requirements and therefore has no areas that are difficult to reach. It can be wipe disinfected.

#### NOTE

##### Approved care, cleaning, and disinfecting agents

Use only care, cleaning, and disinfecting agents that have been approved by Dentsply Sirona, see "Care, cleaning, and disinfecting agents" [→ 204].

#### NOTE

##### The lens window is sensitive to scratches.

Deep scratches in the lens window impair image quality.

- Protect the lens window against scratching. Disinfect it with a soft, lint-free cloth.

## 5.3.5 Maintaining treatment instruments

### 5.3.5.1 Maintaining the multifunctional syringe Sprayvit M

#### 5.3.5.1.1 Replacing O-rings

Replace the O-rings every 3 months.

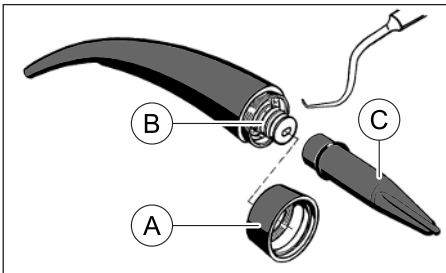

1. Unscrew ring (A) from the nozzle.
2. Remove O-rings (B) with a hook probe.
3. Slide tool (C), with the new O-ring attached, up to just in front of the corresponding groove.
4. Insert the O-ring. Do **not** use any sharp objects.
5. Repeat steps 3-4.
6. Screw ring (A) tightly onto the nozzle.

#### Protect O-rings regularly

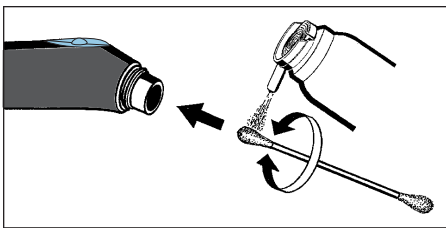

1. Soak a Q-tip in Dentsply Sirona's T1 spray.
2. Wipe the housing at the separating joint with the Q-tip.

#### 5.3.5.1.2 Replacing lamps

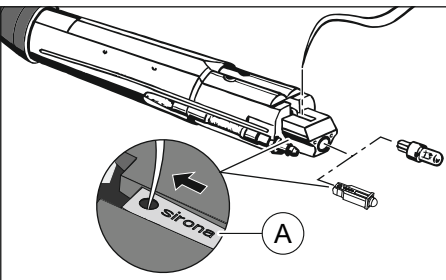

#### **CAUTION**

**The lamp may be hot.**

Risk of burns!

> Allow the lamp to cool down.

1. Switch the treatment center off at the standby switch.
2. Remove the housing from the valve body.
3. Use a probe or the like to pry the lamp out of the socket from the button side.
4. Insert the new lamp, observing the contact surface. The Sirona logo (A) on the LED must face upward. The logo must be legible after inserting it into the slit in the valve body.  
**Tip:** Insert a probe into the hole of the LED and pull the LED into the valve body up to the stop.

### 5.3.5.2 Maintaining the motors

#### 5.3.5.2.1 Lubricate the lock washer

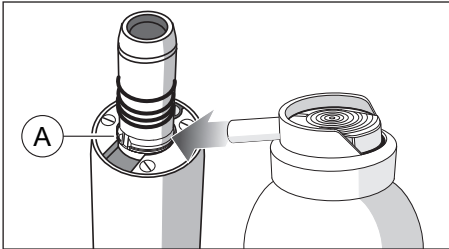

Lubricate the lock washer once a week.

1. Spray some T1 Spray on the lock washer (A).
2. Turn the lock washer to distribute the T1 Spray.

#### 5.3.5.2.2 Replacing lamps and lamp ring (BL motor)

##### CAUTION

**The lamp can be hot.**

Risk of burns!

- > Allow the lamp to cool down.

✓ Use an LED or halogen lamp with a green base.

1. Detach the instrument or adapter.
2. Place the marking of lamp ring **A** over the lamp **B**.
3. Detach the lamp ring.
4. Remove the defective lamp from the socket.
5. Place the new lamp in sideways. Do **not** slide the lamp in from the front. In doing so, note the position of the contact surfaces.

##### NOTE

**The LED may break if you press too hard on the lens.**

- > Use the assembly tool **C** to insert the LED.

6. Attach the lamp ring. The marking on the lamp ring must be over the lamp. The marking points toward the instrument/adapter.
7. Check the light function.

If the LED does not light up:

- > **Remove the LED and re-insert it after rotating it 180° around its own axis.**

#### 5.3.5.2.3 Replacing lamps (BL ISO E/C motor)

##### NOTE

An LED is built into the BL ISO C/E motor. This LED is designed for the service life of the motor and may be replaced only by Dentsply Sirona or a service technician trained by Dentsply Sirona. Safe operation is no longer guaranteed in case of improper replacement.

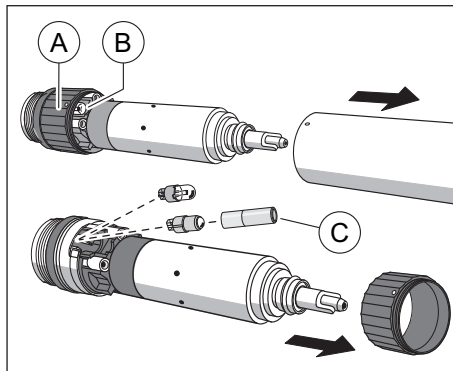

#### 5.3.5.2.4 Replace the sealing washer

If water leaks out between the motor and the hose connection, replace the sealing washer.

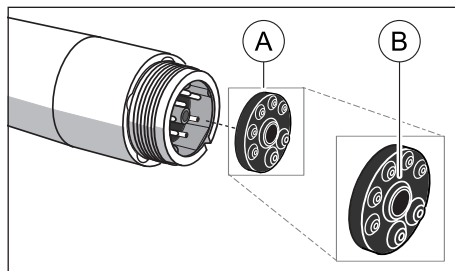

- ✓ The color of the new sealing washer matches the colored mark of the hose coupling that fits the motor.
- 1. Remove the motor from the instrument hose.
- 2. Use a probe or the like to remove the defective sealing washer (B) from the rear of the motor.
- 3. Fit the new sealing washer observing the position of the small tubes and contact pins and slide it as far as it will go.

#### IMPORTANT

The bulging side (A) of the sealing washer faces the instrument hose.

#### 5.3.5.2.5 Replacing O-rings

#### NOTE

Do not use any sharp tools and do not stretch the new O-rings.

If the handpiece coupling leaks, the O-rings must be replaced.

#### IMPORTANT

The BL Implant motor and the Basic Apex adapter have only one O-ring.

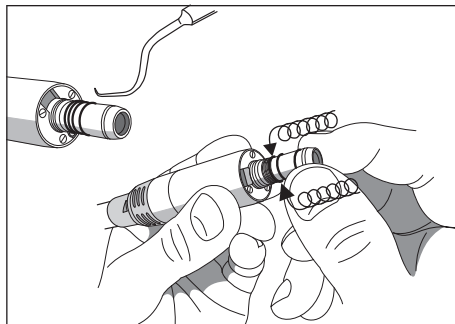

1. Remove the defective O-rings.
2. Insert the O-rings one after another. Start with the first groove.
3. Lightly oil the O-ring with T1 Spray.

#### NOTE

Do **not** use Vaseline or silicone grease on the O-rings.

### 5.3.6 Changing the cotton wool roll on the high-speed handpiece hose and oil collector

At the unit end of the high-speed handpiece hose, return air leaks out along with a small amount of high-speed handpiece oil. This oil is collected in a drip container by the cotton wool roll.

#### Sinius and Sinius TS dentist elements

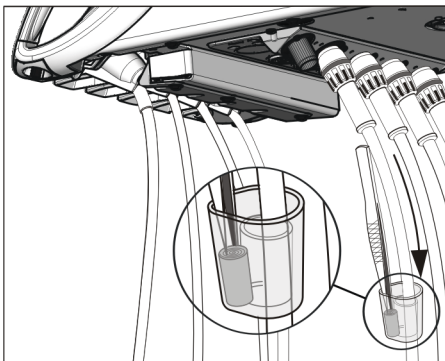

1. Slide the drip container down and remove the cotton wool roll.
2. Insert a new cotton wool roll and slide the container back up.

#### Sinius CS dentist element

##### Cotton wool roll on the high-speed handpiece hose

The instrument connections are located below the instrument holder. The holder is fixed on the front edge with two internal clamps on the dentist element.

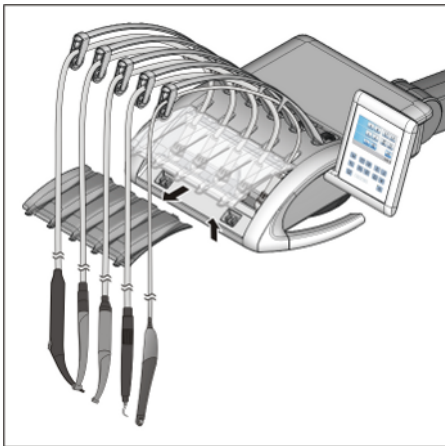

1. The instruments must be removed from the instrument holder. To do this, remove all instruments one after the other and allow these to hang down facing forward.
2. Lift the instrument holder by the front edge until the clamps are released and the holder can be removed.

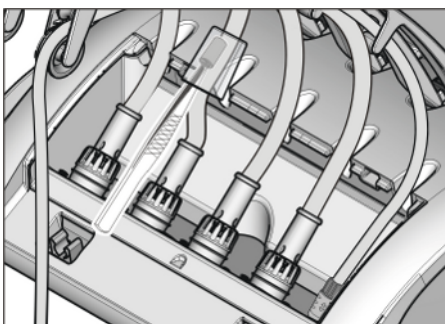

3. Slide the drip container on the high-speed handpiece hose up and remove the cotton wool roll.
4. Insert a new cotton wool roll and slide the container back down.
5. First insert the rear edge of the instrument holder into the groove on the dentist element. Then push the holder forward and down until it clicks into place.
6. Place the instruments in their holders. Make sure that the instrument hoses are located in the guide rollers of the swivel arm.

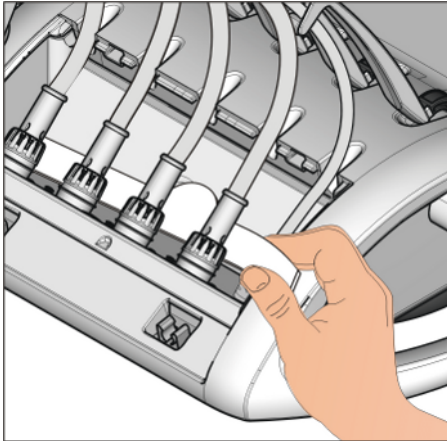

### Oil collector

The Sinus CS dentist element is also equipped with an oil collector. It is located below the instrument connections and collects any liquids that leak out.

1. Remove the instrument holder from the dentist element, as described above.
2. Pull out the oil collector located under the instrument connections and replace it.

To reorder the oil collectors, see "Spare parts and consumables" [→ 285].



## 5.4 Vacuum system

### 5.4.1 Cleaning the suction hoses

The suction system is exposed daily to secretions, saliva, and blood that contain bacteria. Therefore, for reasons of hygiene, the used suction hoses must be cleaned after each patient, in particular after every treatment involving blood. For prolonged treatments, the suction hose must be cleaned every 60 minutes.

The suction system can be cleaned by pumping water into a tank behind the suction hose adapter and extracting it from there. A cleaning agent is added to the water if the dental treatment center is equipped with the chemical suction hose cleaning option. The cleaning agent tank is accessible via the maintenance flap on the base of the water unit.

In the Setup of the treatment center, the amount of cleaning agent to be mixed with water for suction hose cleaning can be set, see "Adjusting cleaning agent mixture for chemical suction hose cleaning" [→ 197].

#### Clean suction hoses and suction system

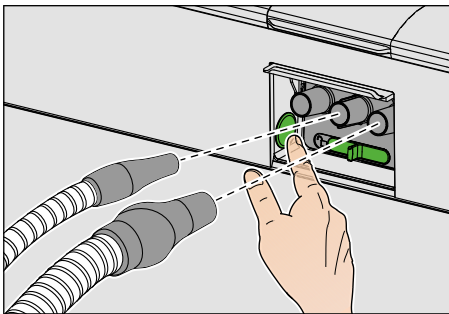

1. Remove the suction tips from the suction hoses to be cleaned.
2. Disinfect the suction handpieces before connecting the suction hoses to the adapters on the water unit.
3. Swivel the cover cap for the suction hose adapters on the assistant's side of the water unit upward.
4. Attach the suction hoses onto the adapters. When using two large and one small suction hose, the small suction hose must be placed in the middle.
5. Press the button.
  - ↳ The mixture of water and cleaning agent (optional) is pumped into the suction hose cleaning tank and drawn off by the suction hoses. An acoustic signal will sound after completing the suction hose cleaning.
6. The process can be repeated if necessary by activating the key again.

#### **⚠ CAUTION**

The suction hose cleaning must not be interrupted to ensure that no water remains in the container.

7. Then place the suction hoses back into their holders on the assistant element.

Thermally disinfect the cartridge for the suction hoses weekly, see "Thermally disinfect the the cartridges for sanitization adapter and suction hose cleaning" [→ 253].



### Refilling the cleaning agent

When the adjacent display appears in the status bar of the touchscreen, the cleaning agent for cleaning the suction system is almost depleted. It should then be refilled as soon as possible.

#### CAUTION

**It is possible that the cleaning agent for the suction system and the agent for disinfecting the water paths could get mixed up.**

- Do **not** fill the agent for disinfecting the water paths into the cleaning agent tank for chemical suction hose cleaning! Use only "Agents for the suction lines" approved by Dentsply Sirona, see "Care, cleaning, and disinfecting agents" [→ 204].

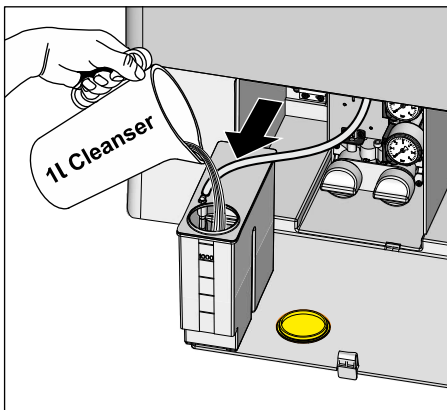

1. Open the maintenance flap on the base of the water unit. The cleaning agent tank for chemical suction hose cleaning is located on the left side.
2. Pull the tank slightly out of the water unit. At the same time, check the hose line.
3. Open the cap of the tank and add the cleaning agent. The cleaning agent tank has a capacity of 1 liter.

## 5.4.2 Cleaning the suction system using the suction hose adapter for the cuspidor or via an external tank

If the treatment center is not equipped with the chemical suction hose cleaning option, only water is used for cleaning the suction hoses. The suction system must therefore be cleaned daily using the suction hose adapter for the cuspidor or via an external container.

The suction system is exposed to secretions, saliva, and blood that contain bacteria. Cleaning at regular intervals is therefore absolutely mandatory for hygienic reasons.

### NOTE

#### Approved care, cleaning, and disinfecting agents

Use only care, cleaning, and disinfecting agents that have been approved by Dentsply Sirona, see "Care, cleaning, and disinfecting agents" [→ 204].

### NOTE

#### Domestic cleaning agents foam up.

Foaming cleaning agents often cause foam and water to be sucked into the dry suction system. This can cause damage to the suction machine.

- Use only care, cleaning, and disinfecting agents approved by Dentsply Sirona, see "Care, cleaning, and disinfecting agents" [→ 204].

### 5.4.2.1 Cleaning the suction system using the suction hose adapter for the cuspidor

#### Preparation for cleaning

1. Prepare 1 liter of cleaning solution in a separate container according to the manufacturer's instructions and mix it thoroughly.
2. Remove the gold trap (A).
3. Clean the cuspidor.
4. Insert the suction hose adapter for the cuspidor (B) up to the stop.
5. Remove the suction tips from the suction hoses.
6. Attach the adapter (C) to the saliva ejector.

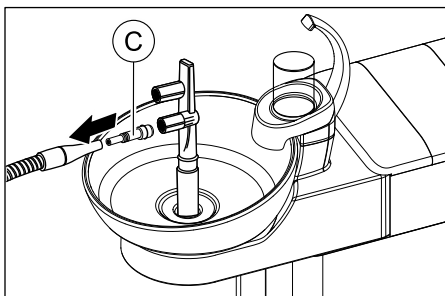
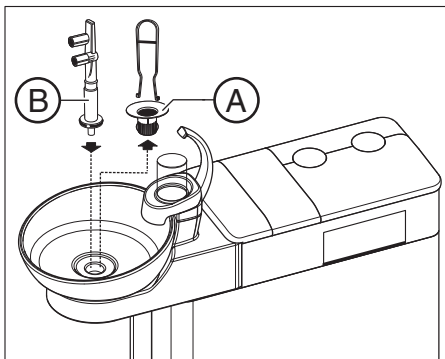

### Cleaning procedure

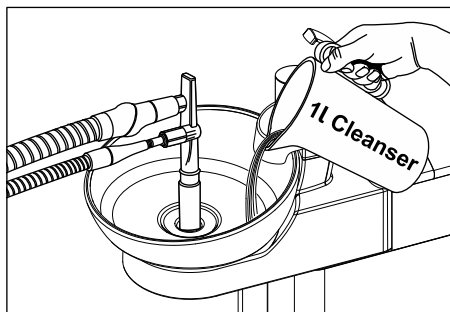

1. Pour 1 liter of cleaning solution into the cuspidor.
2. Remove the suction hoses from their holders and attach them to the side of the suction hose adapter for the cuspidor as simultaneously as possible.
  - ↳ Two thirds of the cleaning solution will be suctioned off by the suction hoses; one third will flow into the drain of the cuspidor.
3. Allow the cleaning solution to act. Observe the reaction time specified for the cleaning solution by the manufacturer.

### Rinsing the cleaning agent

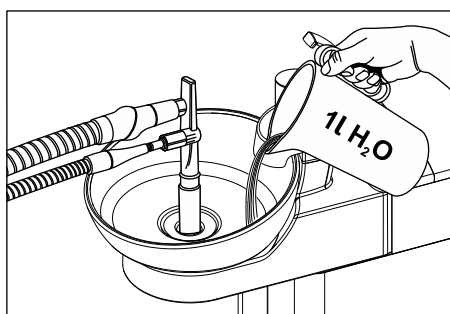

1. Following the cleaning process, pour at least 1 liter of water into the cuspidor.
  - ↳ The water is suctioned off, thus preventing any cleaning agent residues from remaining in the suction hoses.
2. When the aspiration process has been completed, detach the hoses. Place the suction hoses back in their holders.
3. Remove the suction hose adapter for the cuspidor and put the gold trap back in.

If the treatment center is equipped with a third suction hose, repeat the procedure.

If the water unit is equipped with a standard wet suction, the filter insert of the standard wet suction must also be cleaned once a month after cleaning the suction system; see "Cleaning the filter insert of the standard wet suction" [→ 261].

#### 5.4.2.2 Cleaning the suction system via external container

If the treatment center is not equipped with a cuspidor, the suction system must be cleaned using an external container.

1. Prepare 1 liter of cleaning solution in a separate container according to the manufacturer's instructions and mix it thoroughly.
2. Fill the cleaning solution into a suitable container.
3. If the tank is equipped with suitable adapters for the suction hoses, remove the suction tips from the suction hoses. Otherwise, the cleaning solution must be aspirated with the suction tips in place.
4. Remove the suction hoses from their holders and aspirate the cleaning solution from the container with all suction hoses simultaneously.
5. Allow the cleaning solution to act. Observe the reaction time specified for the cleaning solution by the manufacturer.
6. Following the cleaning process, pour at least 1 liter of water into the container. Aspirate the water in the same way to ensure that no cleaning agent residues remain in the suction hoses.
7. After finishing, place the suction hoses back in their holders.

### 5.4.3 Sterilizing/disinfecting and lubricating the suction handpieces

#### Sterilization/disinfection

All parts of the suction handpieces can be sterilized and thermally disinfected.

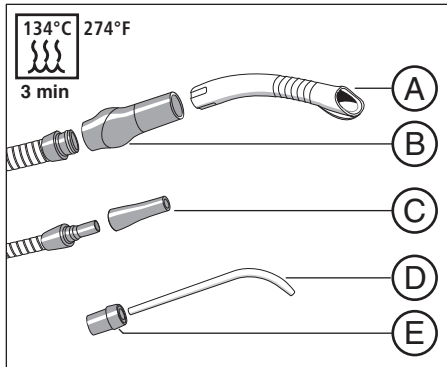

A	Suction tip
B	Suction Handpiece
C	Saliva ejector handpiece
D	Surgical suction tip
E	Adapter

#### Lubricating suction handpieces

The disconnection points of the suction handpieces must be lubricated once a week and after each thermal disinfection or sterilization process.

#### **⚠ CAUTION**

##### Unsuitable lubricants

Lubricants that are not food safe may endanger the patient's health. Rubber materials such as O-rings are corroded by unsuitable lubricants.

- Never use petroleum jelly or similar lubricants.
- Use only lubricants approved by Dentsply Sirona.

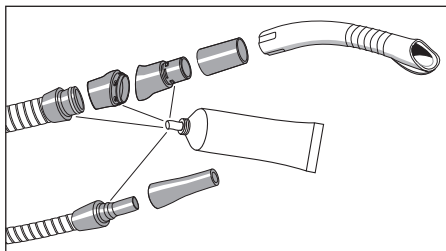

1. Pull the handpiece of the spray aspirator, the saliva ejector and, if installed, the surgical suction device off of their suction hoses.
2. Take apart the handpiece of the spray aspirator at its joints.
3. Lubricate the disconnection points and O rings of the handpieces.

### 5.4.4 Clean the filter in the suction hoses and disinfect the suction hoses

The hoses of the spray aspirator and the saliva ejector as well as the connection hose to the water unit can be removed for rinsing under running water.

Filter inserts are placed between the suction hoses and the assistant element to filter out solid particles. Depending on the treatment involved, it may be necessary to remove the trapped solid particles (e.g. amalgam) from the collector periodically due to a decrease in suction power.

#### CAUTION

**Amalgam residues must not enter the public sewage system.**

Amalgam is a mercury compound that is hazardous to water.

- > Do not dispose of amalgam residues in a sink.
- > Collect amalgam residues in a closed container with water. Dispose of amalgam residues, e.g. when replacing the amalgam rotor by filling the amalgam residues into the amalgam rotor or when emptying the sediment container.

The outside of the suction hoses can be disinfected by wiping.

#### NOTE

**Powdering suction hoses with talcum**

If the surfaces of the hoses have become sticky from disinfectants, clean them with a commercially available dishwashing liquid and then powder them with a light coat of talcum if necessary.

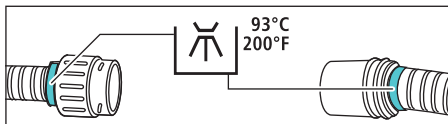

Thermally disinfected suction hoses are not standard equipment of the treatment center. Thermally disinfected suction hoses are available as special accessories. They are marked with a turquoise ring.



#### WARNING

Wear gloves when performing the following work.

If the treatment center is equipped with a second spray aspirator or saliva ejector for surgical suction, the following instructions must be performed analogously.

1. Switch the treatment center off at the standby switch.



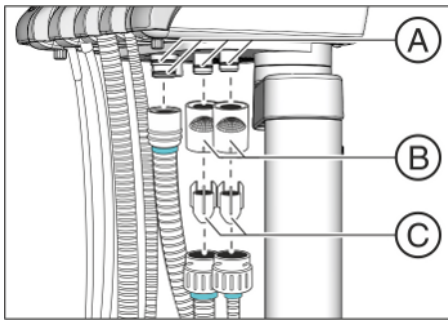

2. Pull the filter housing **B** off of the connectors on the assistant element.
3. Disconnect the suction hoses from the filter housings **B**.

4. Take the collectors **C** out of the suction hoses. Collect the amalgam residues in a glass filled with water.
5. Take off the suction cannulae and rinse out the suction hoses with clean water.
6. Disinfect the suction hoses with a wipe disinfection agent for dental instruments and hoses.

If the treatment center is equipped with thermodisable suction hoses, thermal disinfection can be performed after cleaning.

Assemble in reverse order. Lubricate the O-rings **A** before reconnecting the suction hoses. For lubricants see "Care, cleaning, and disinfecting agents" [→ 204]. Make sure that the suction hoses snap into place.

## 5.5 Components of the water unit

### 5.5.1 Clean the gold trap

The gold trap retains larger solid particles to prevent them from being washed down the drain in the cuspidor bowl. The amalgam rotor must be replaced and the sediment container must be emptied less often.

#### NOTE

**Amalgam residues must not enter the public sewage system.**

Amalgam is a mercury compound that is hazardous to water.

- Do not dispose of amalgam residues in a sink.
- Collect amalgam residues in a closed container with water. Dispose of amalgam residues, e.g. when replacing the amalgam rotor by filling the amalgam residues into the amalgam rotor or when emptying the sediment container.

#### ⚠ CAUTION

**Amalgam residues must not enter the public sewage system.**

Amalgam is a mercury compound that is hazardous to water.

- Do not dispose of amalgam residues in a sink.
- Collect amalgam residues in a closed container with water. Dispose of amalgam residues, e.g. when replacing the amalgam rotor by filling the amalgam residues into the amalgam rotor or when emptying the sediment container.

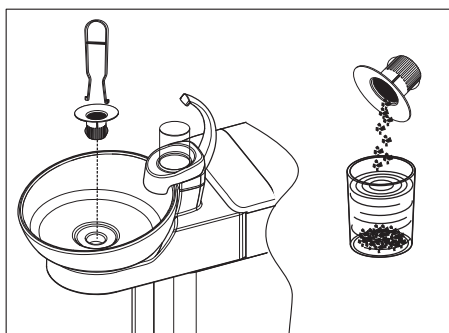

1. Remove the gold trap from the drain of the cuspidor bowl.
2. Remove the amalgam residues from the gold trap. Amalgam residues must be disposed of separately.
3. Clean the gold trap.
4. Reinsert the gold trap.



### 5.5.2 Clean/disinfect the cuspidor

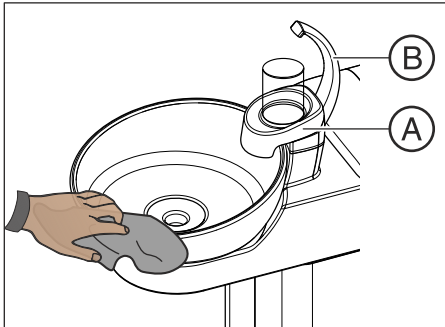

The cuspidor bowl, the tumbler holder **A** and the tumbler outlet **B** can be wiped with surface disinfectants.

Clean and disinfect the cuspidor bowl with a special cleaning agent. This agent will also clean the drain lines of the cuspidor.

#### NOTE

##### Domestic cleaning agents foam up.

Foaming cleaning agents often cause foam and water to be sucked into the dry suction system. This can cause damage to the suction machine.

- Use only care, cleaning, and disinfecting agents approved by Dentsply Sirona, see "Care, cleaning, and disinfecting agents" [→ 204].

The cuspidor bowl is attached to the water unit via a bayonet catch and can be removed for thorough cleaning. The tumbler holder **A** can remain attached when doing this.

#### ⚠ CAUTION

**When the treatment center is switched on, the flushing and tumbler filling functions can be activated even if the cuspidor bowl is removed.**

In this case, water would run onto the floor and could enter the treatment center.

- Switch the treatment center off at the standby switch before removing the cuspidor bowl.

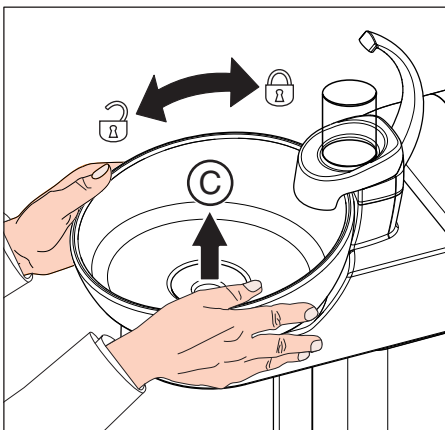

1. Remove the gold trap **C**.
2. Hold the cuspidor bowl firmly with both hands. Loosen the bayonet catch by twisting the cuspidor bowl counterclockwise.

A rubber gasket is attached to the bayonet catch of the water unit to seal its closure. Lubricate this gasket before reinserting the cuspidor bowl. For lubricants, see "Lubrication, cleaning, and disinfecting agents" [→ 250].

Make sure that the bayonet catch snaps into place when you reinsert it.

After snapping into place, the higher side of the cuspidor bowl must be located below the tumbler outlet.

### 5.5.3 Cleaning the outlet lines of the cuspidor

With the chemical suction hose cleaning option, the drain outlets of the cuspidor are not cleaned/disinfected. If the treatment center is equipped with this option, the drains of the cuspidor must therefore be cleaned weekly. Use the same agent as for the suction lines.

#### NOTE

##### Approved care, cleaning, and disinfecting agents

Use only care, cleaning, and disinfecting agents that have been approved by Dentsply Sirona, see "Care, cleaning, and disinfecting agents" [→ 204].

#### NOTE

##### Domestic cleaning agents foam up.

Foaming cleaning agents often cause foam and water to be sucked into the dry suction system. This can cause damage to the suction machine.

- Use only care, cleaning, and disinfecting agents approved by Dentsply Sirona, see "Care, cleaning, and disinfecting agents" [→ 204].

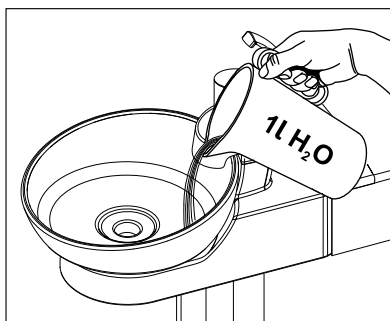
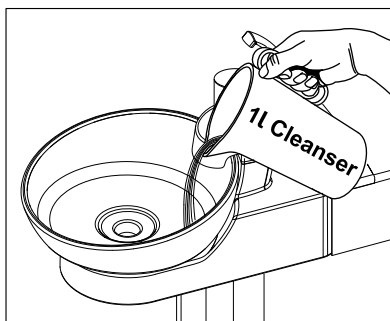

1. Prepare 1 liter of cleaning solution in a separate container according to the manufacturer's instructions and mix it thoroughly.
2. Fill the cuspidor with the cleaning solution and leave it to take effect. Observe the reaction time specified for the cleaning solution by the manufacturer.
3. Rinse the cleaning solution away. To do this, pour at least 1 liter of water into the cuspidor.

### 5.5.4 Refill disinfectant for the water paths

The water unit can be optionally equipped with a disinfection system. In normal operation, this will automatically inoculate the water that comes in contact with the patient (also called treatment water) with an agent to disinfect the water paths. This leads to a decrease in bacterial growth and to the reduction of the bacteria in the water. Furthermore, the disinfection system can also be used to disinfect the water paths, see "Interactive sanitizing of the treatment center" [→ 264]. If you decide to operate the treatment center without the disinfection system, please refer to the information in the chapter "Media quality" [→ 15].

#### **⚠ WARNING**

##### **Microorganisms can multiply in the water.**

These microorganisms could increase the risk of damage to one's health.

- If the treatment center is equipped with a disinfection system, never operate this to disinfect the water paths without disinfectant.

Desinf

10:45:03 B

When the supply of disinfectant for sanitizing the water paths in the reservoir begins to run short (< 300 ml), the *Disinf* display appears in the status bar of the touchscreen. Treatment can nevertheless be continued. Refill the disinfectant as soon as possible.

If the *Disinf* display does not appear, agent for disinfecting the water paths should not be refilled. The treatment center may detect that consumption of disinfectant is too low due to regular refilling and report an error. See "Error messages," [→ 282] Code 14.

1. Open the cover of the disinfectant tank.
2. Refill the agent for disinfecting the water paths. The refill container has a capacity of approx. 1.3 liters. It is full when the disinfectant is visible at the filter of the funnel tube.
  - ↳ The *Disinf* display is hidden.

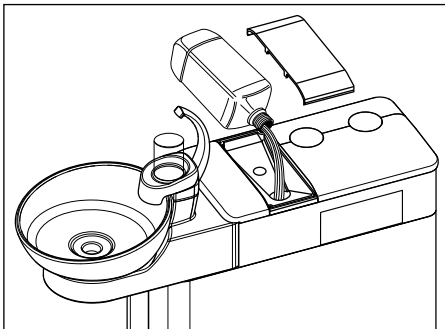

#### **⚠ WARNING**

##### **It is possible that the cleaning agent for the suction system and the agent for disinfecting the water paths could get mixed-up.**

- Do **not** fill the agent for chemical suction hose cleaning into the disinfectant tank of the water unit. Use the agent for disinfecting the water paths, see "Care, cleaning, and disinfecting agents" [→ 204].

#### **NOTE**

Splashes of undiluted disinfectant for sanitizing the water paths can result in discoloration of surfaces if left for too long.

Any splashes should therefore be removed immediately using a moist cloth.

To reorder the disinfectant for sanitizing the water paths, see "Spare parts and consumables" [→ 285].

#### NOTE

##### **Approved care, cleaning, and disinfecting agents**

Use only the agent for disinfecting the water paths that has been approved by Dentsply Sirona for the disinfection system; see "Care, cleaning, and disinfecting agents" [→ 204].

### 5.5.5 Thermally disinfect the the cartridges for sanitization adapter and suction hose cleaning

The sanitizing adapters are placed in a cartridge and can be removed from the water unit with this for cleaning and thermo disinfection. The cartridge for the suction hose receptacles is also removable.

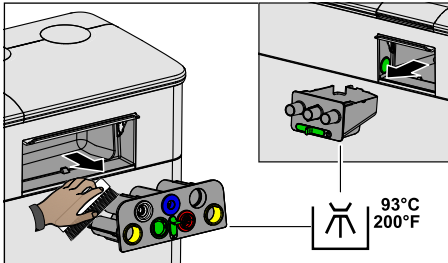

1. Move the green lever to release the locking of the cartridges on the dentist and assistant side. Note the open and closed lock symbol. Pull the cartridges out of the water unit.
2. Wipe out the two openings on the water unit with a moist cloth.
3. Clean the cartridges with a moist cloth and brush.
4. Thermally disinfect the cartridges. When doing so, leave the sanitizing adapters inserted in the cartridge.
5. Slide the cartridges back into the water unit. Lock them by moving the green lever.

To reorder the cartridges and sanitization adapters, see "Spare parts and consumables [-> 285]".

### 5.5.6 Change the water and air filters

If you notice any changes in media flows, check that the water and air filters are permeable. The filters must be replaced, if necessary.

To reorder the filters, see "Spare parts and consumables" [-> 285].

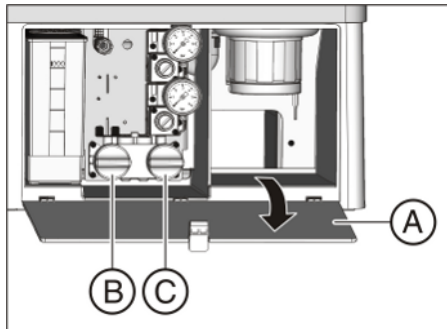

1. Switch the treatment center off at the standby switch.  
↳ The water and air supply are switched off.
2. Open the maintenance flap (A).
3. Any remaining water flows out of the water filter when it is opened. You should therefore place an absorbent cloth underneath the filter. Then unscrew and remove the screw cap of the water filter (B) and/ or the air filter (C).
4. Check the filters and replace them if necessary.

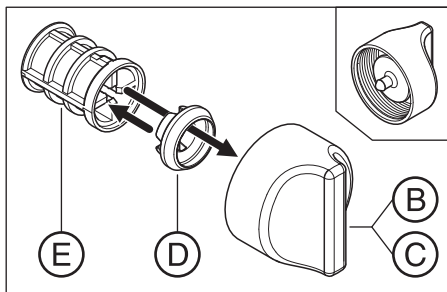

5. Put the seal (D) back on the filter (E). Then insert both into the screw cap (B), (C) as shown.  
↳ The filter (E) clicks into the screw cap (B), (C).
6. Screw the screw-on cap(s) (B), (C) back onto the water unit.

### 5.5.7 Changing the amalgam rotor

Amalg

10:45:03 B

Amalgam residues and other solid particles are trapped in the amalgam rotor according to the centrifugal principle.

When the *Amalg* display appears in the status bar of the touchscreen, the amalgam rotor is almost full and must be replaced as soon as possible. An acoustic signal sounds when the rotor is completely filled. In this case, a safety shutoff function ensures that the rotor is exchanged before the treatment center can be used again.

Regardless of whether or not the *Amalg* display lights up, the amalgam rotor must be replaced **at least once a year**.

#### CAUTION

**Amalgam residues must not enter the public sewage system.**

Amalgam is a mercury compound that is hazardous to water.

- > Do not dispose of amalgam residues in a sink.
- > Collect amalgam residues, e.g. from the gold trap of the cuspidor bowl, in a closed container with water. Dispose of amalgam residues when replacing the amalgam rotor by filling the amalgam residues into the amalgam rotor.

#### CAUTION

**Disposal of the amalgam rotor**

When a replacement rotor is supplied, a package for the return shipment of the filled amalgam rotor is attached.

Authorize only certified waste management companies to dispose of rotors.

#### Cleaning the suction system

The amalgam rotor is exposed to secretions, saliva and blood that contain bacteria. It is therefore important to clean the suction system before replacing the amalgam rotor.

If the treatment center is equipped with the chemical suction hose cleaning option, see "Cleaning the suction hoses" [→ 241]. If this option is not available, see "Cleaning the suction system using the suction hose adapter for the cuspidor or via an external tank" [→ 243].

#### Removal and disposal of the amalgam rotor

#### WARNING

Wear gloves when performing the following work.

- ✓ The treatment center is switched on.
1. Open the flap **A** on the base of the water unit.
  2. Loosen the bayonet catch by turning the lower part of the amalgam separator **B** counterclockwise. Remove the lower part of the amalgam separator along with the amalgam rotor located inside it.
    -  The message "Amalg" appears on the touchscreen and an acoustic signal sounds.

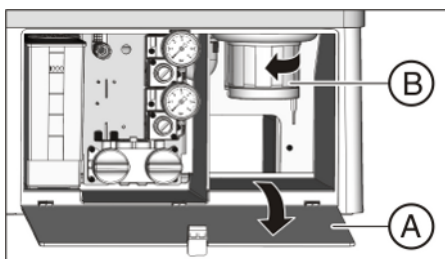

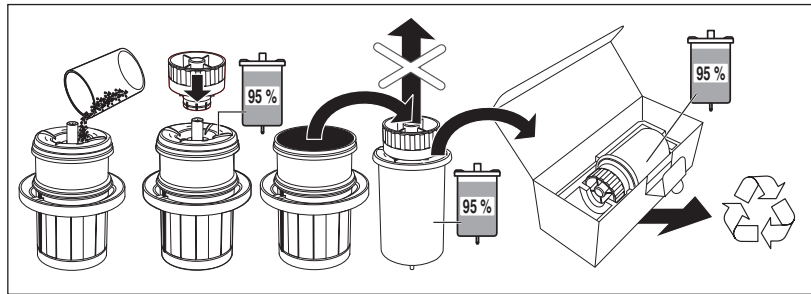

3. Dispose of the collected amalgam residues from the cuspidor bowl and from the suction hoses in the amalgam rotor; see "Cleaning the gold trap" [→ 248] and "Cleaning and disinfecting the suction hoses" [→ 246]. Fill the amalgam residues into the amalgam rotor.
4. Hold the lower part of the amalgam separator upright. Attach the transport cap to the amalgam rotor.
  - ↳ The transport cap clicks into place. Do not remove the transport cap after closing it.
5. Remove the amalgam rotor with the transport cap from the lower part of the amalgam separator.
6. Place the container in the special packaging and ship it for disposal or authorize a certified waste management company.

### Installing the amalgam rotor

Use only original Dentsply Sirona accessories. Never use a used or recycled amalgam rotor.

To reorder the amalgam rotor, see "Spare parts and consumables" [→ 285].

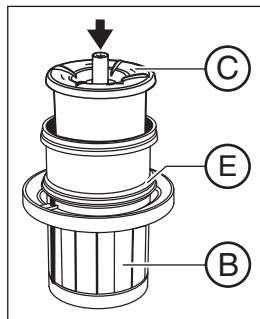

1. Grease the O-ring **E** on the lower part of the amalgam separator. For lubricants, see "Care, cleaning and disinfecting agents" [→ 204].
2. Insert the new amalgam rotor **C** in the lower part of the amalgam separator **B**.
3. Hold the lower part of the amalgam separator **B** so that the latching noses of the bayonet catch are positioned transverse to the water unit. Screw the lower part of the amalgam separator **B** onto its upper part by rotating it clockwise.

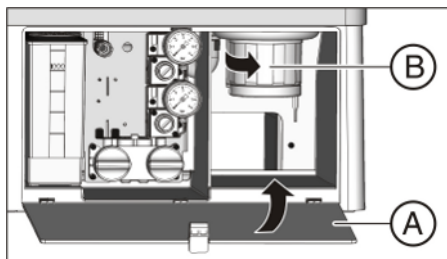

### NOTE

#### Amalgam separator message

If the message *Amalg* is still displayed on the touchscreen and the acoustic signal persists after the amalgam rotor has been inserted, the lower part of the amalgam separator is not properly locked.

4. Close the flap **A**.
5. In Germany: Document the exchange of the amalgam rotor in the "D3181 II amalgam separator operation log".  
 International: Document in accordance with the national regulations.



### **Amalgam separator operator's log**

In Germany, users are obligated by law to keep an operation log for the amalgam separator. This log is included with the treatment center. Please note the user duties as described in the operation log:

- Document the replacement of the amalgam rotor
- Check the function of the amalgam separator system annually
- Arrange for a 5-year inspection

### 5.5.8 Check the message system of the amalgam separator

Amalg 10:45:03 B

An electronic control monitors the function of the amalgam separator. It detects any mechanical blocking or failure of the drive motor. The error is indicated by the *Amalg* display on the touchscreen and by an acoustic signal.

The functionality of this message system must be checked at least **once per year**.

Inform your service technician if the error occurs during regular operation.

In Germany: Document the test in the operation log of the amalgam separator in the "Testing the function of display and message systems" section.

- ✓ All instruments are in their holders. The Start dialog is displayed on the touchscreen.



Setup

1. Press and hold the *Setup* fixed key (> 2 s).

↳ The *Setup dialog* appears.



2. In the setup dialog, hold and press the *Service* key (> 2 s).

↳ The service dialog is shown.

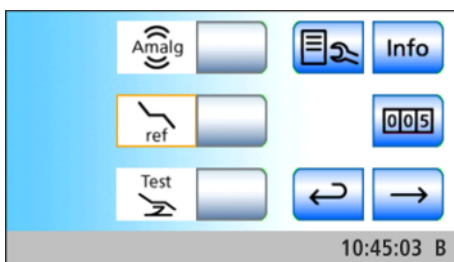

3. Test the message system. Press and hold the *Amalg* key for an extended period.

↳ The message system is working if a signal sounds as long as the *Amalg* key is pressed.

Inform your service technician if the acoustic signal does not sound.

Press the *Back* key to exit the service dialog.



### 5.5.9 Emptying the sediment container

In addition to other solid particles, a large proportion of the amalgam residues are trapped in the sediment container by gravitational force.

Empty the sediment container in cycles that are appropriate for your work method, but at least every 4 weeks.

The sediment container is installed only if neither an amalgam separator nor a standard wet suction is installed.

#### Cleaning the suction system

The sediment container is exposed to secretions, saliva and blood that contain bacteria. It is therefore important to clean the suction system before removing the sediment container.

If the treatment center is equipped with the chemical suction hose cleaning option, see "Cleaning the suction hoses" [→ 241]. If this option is not available, see "Cleaning the suction system using the suction hose adapter for the cuspidor or via an external tank" [→ 243].

#### Removing and emptying the sediment container



#### **! WARNING**

Wear gloves when performing the following work.

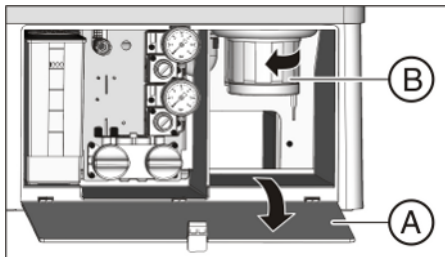

1. Open the flap **A** on the base of the water unit.
2. Loosen the bayonet catch by turning the sediment container **B** counterclockwise.

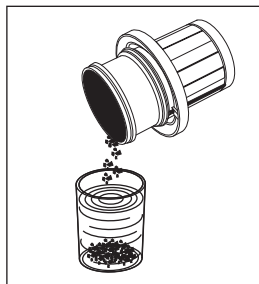

3. Pour the excess water out of the sediment container and collect the amalgam residues. Dispose of these properly together with the amalgam residues collected from the cuspidor bowl and from the suction hoses; see "Cleaning the gold trap" [→ 248] and "Cleaning and disinfecting the suction hoses" [→ 246].

#### Installing the sediment container

1. Lubricate the O-ring **C** on the sediment container. For lubricants, see "Care, cleaning and disinfecting agents" [→ 204].

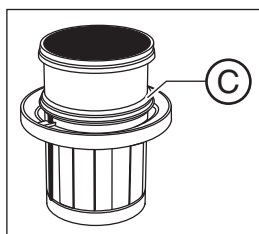

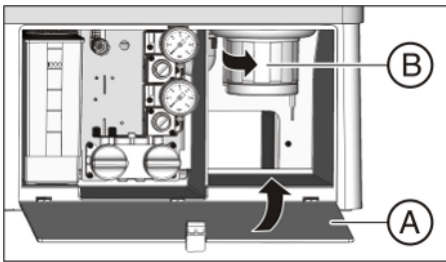

2. Hold the sediment container **B** so that the latching noses of the bayonet catch are positioned transverse to the water unit. Rotate the sediment container **B** clockwise.  
↳ The sediment container is locked in place.
3. Close the flap **A**.

### 5.5.10 Cleaning the filter insert of the standard wet suction

The automatic separator and amalgam separator or sediment container are not installed in the water unit for wet suction. The separation of air and water and amalgam separation are performed centrally in this case.

In order to ensure that larger solid particles nevertheless cannot enter the separating unit, the vacuum line in the water unit is equipped with a filter. The filter insert must be cleaned when the suction power decreases.



#### **WARNING**

Wear gloves when performing the following work.

#### Cleaning the suction system

Before the filter insert of the standard wet suction is cleaned, the suction system should be cleaned.

If the treatment center is equipped with the chemical suction hose cleaning option, see "Cleaning the suction hoses" [→ 241]. If this option is not available, see "Cleaning the suction system using the suction hose adapter for the cuspidor or via an external tank" [→ 243].

#### Opening Start sub-dialog

- ✓ The *Start dialog* is displayed on the touchscreen.
- > In the *Standard Start dialog*: Touch the *Sub-dialog* key.  
In the *EasyMode Start dialog*: Press the *Chair* program change key.



- ↪ The *Start* sub-dialog is displayed.

#### Extracting all remaining water

As long as the treatment center is switched on, water remains in the vacuum line for technical reasons. The water must first be completely extracted to allow the filter insert to be cleaned, otherwise the remaining water will flow out when the filter housing is opened. The remaining water is automatically extracted when the treatment center is switched off at the standby switch on the user interface. The remaining water is automatically extracted when the treatment center is switched off at the standby switch.



- > Touch the *Extract residual water* key.
- ↪ As long as the key is lit up orange, water is being extracted from the water unit. A slurping noise indicates that the water

unit is completely empty. When the key turns gray the extraction process is finished.

### Removing and cleaning the filter insert

#### NOTE

**The flushing and tumbler filling functions may not be activated when the filter housing is open.**

Otherwise, water could escape from the open filter housing.

- Do not switch the flushing and tumbler filling functions on whenever the filter housing is open.

✓ Water completely extracted from the water unit.

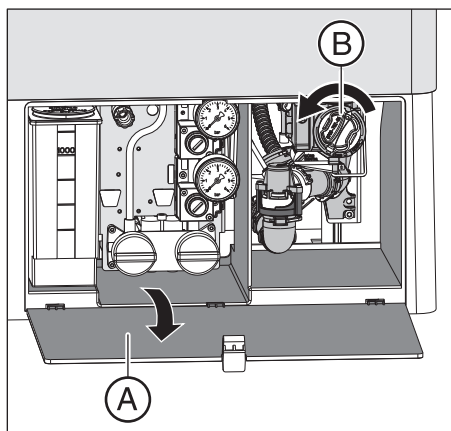

1. Open the flap **A** on the base of the water unit.
2. Loosen the bayonet catch of the filter insert **B**. Unscrew the filter insert from the filter housing of the wet suction device counterclockwise.



3. Properly dispose of the amalgam residues together with the amalgam residues collected from the cuspidor bowl and from the suction hoses. Then clean the filter insert under running water in a sink (not in the cuspidor!).

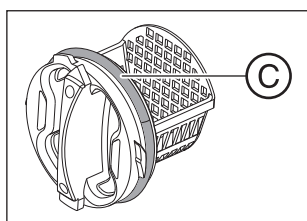

4. Grease the O-ring **C** of the filter insert. For lubricants, see "Lubrication, cleaning, and disinfecting agents" [-> 204].

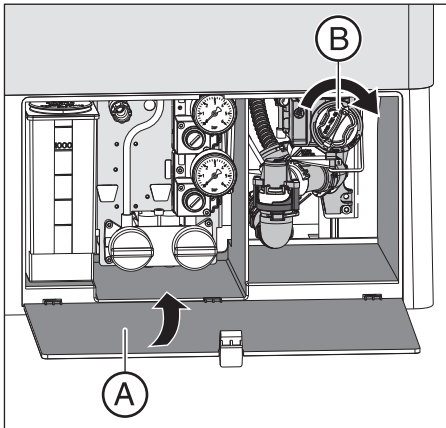

5. Reinsert the filter insert in the filter housing. Rotate the filter insert **B** clockwise.
6. Close the flap **A**.  
↳ The treatment center is again ready for operation.

## 5.6 Sanitation

Sanitation effectively combats the reproduction of microorganisms in the water paths.

If the disinfection system is set for operation with public drinking water supply, the sanitization must be guided using the sanitization screen, see "Interactively guided sanitation of the treatment center" [→ 264].

If the equipment is being operated with a self-sufficient water supply, sanitation can only be carried out manually, see "Sanitizing the treatment center manually" [→ 272]. The *Sanitation* program is not available in this operating mode.

For more information, please refer to the section entitled "Self-sufficient water supply" [→ 162].

### 5.6.1 Interactively guided sanitization of the treatment center

Sanitization, i.e. disinfecting the treatment water lines, can be performed using the disinfection system. During sanitization, the treatment water is first emptied according to a specified process, then the disinfectant for the water lines is filled undiluted into the treatment water lines and flushed out again at the end. Sanitization includes several phases and takes at least 24 hours but should not exceed 3 days.

When operating with public drinking water supply (self-sufficient water supply switched off), interactive sanitization should be carried out:

- Regularly every 4 weeks  
The display *Days until next sanitization* appears in the status bar of the touchscreen. It first appears three days before the date of sanitization (3d = 3 days until sanitization).
- After longer periods of disuse (> one week)
- If the bacterial count exceeds 100 bacteria per milliliter, see "Microbiological water test" [→ 204].
- After changing from stand-alone water supply to public drinking water supply and the agent for disinfecting the water paths

#### NOTE

**Additional devices connected to the external device connection must not be sanitized with the treatment center.**

The additional devices could be damaged. Residues of the agent for disinfecting the water paths can remain in the additional devices.

- > Disconnect any additional devices from the treatment center prior to sanitization.

#### Preparation

The following preparations should be made prior to beginning sanitization.



1. If your treatment center is equipped with a cuspidor, activate the cuspidor flushing for at least one minute. This flushes the water paths.

San 10:45:03 B  
3 d



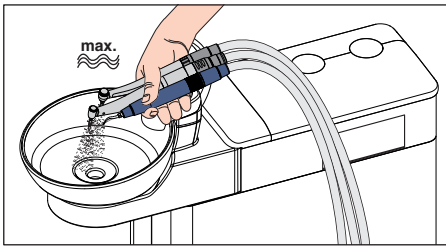

2. Set all bur drives and the SiroSonic TL scaler to the maximum water flow rate.
3. Put all instruments and suction hoses in their holders.
4. Do **not** remove the tumbler holder from the cuspidor. Put an empty glass with a volume  $\geq 200$  ml under the tumbler outlet to prevent discoloration from the disinfectant for the water lines.

### Opening the sanitization dialog via the touchscreen

- ✓ The *start dialog* is displayed on the touchscreen.
1. In the *start dialog standard version*: Touch the *Sub-dialog* key.  
In the *start dialog simplified version*: Press the *Chair* dialog change key.



↪ The *Start* sub-dialog is displayed.



2. Touch the *San* key.

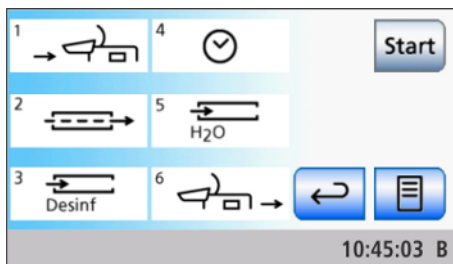

↪ The *Sanitization* dialog is displayed on the touchscreen.



Symbols 1 to 6 stand for the individual sanitization phases as described below. The current sanitization phase is highlighted by an orange rectangle.

### Symbol legend

The status of the individual instruments is represented by symbols on the touchscreen as operational help and for support in case of an error. These symbols have the following meaning:

-  • Empty gray circle  
Instrument cannot be sanitized
-  • Solid gray circle  
Instrument not yet sanitized
-  • Solid orange circle  
Instrument sanitized



- Crossed-out solid gray circle  
Instrument excluded from sanitization, after a failed flow rate check or if an instrument was returned during the reaction time



- Warning triangle  
Check instrument or tumbler filling

The top row of symbols indicates the instrument positions in the dentist element, while the bottom row indicates the instrument positions in the assistant element.

### Start sanitization



- > Touch the *Start* key.  
↳ The sanitization process starts.

### Error message: Refill disinfectant for water lines



If the *Disinf* display appears after the sanitization process has been started, the supply of disinfectant for the water paths in the reservoir of the water unit is not sufficient to sanitize the treatment center. Sanitization cannot be started with too little disinfectant, see "Refilling disinfectant for the water lines" [→ 251].

### Error message: Deposit instruments in instrument holders

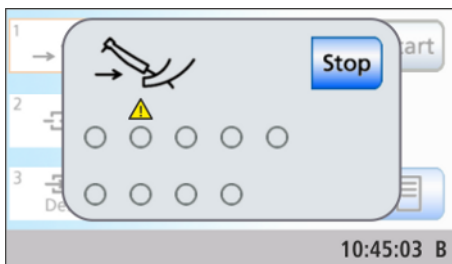

If the *Deposit instruments* display appears after sanitization has been started, the treatment center has detected that not all of the instruments have been placed in their holders.

- > Check the seating of the instruments in the holders marked with a warning triangle on the touchscreen.  
↳ When all of the instruments have been deposited, sanitization phase 1 begins automatically.

### Sanitization phase 1 – Inserting instruments and suction hoses into the water unit

The water unit has integrated sanitization adapters for water-carrying instruments and adapters for suction hoses. This allows all instruments and suction hoses to be simultaneously treated with a high concentration of sanitizing solution and then rinsed with water. For this purpose, sanitizable instruments must be inserted in the sanitization adapters and suction hoses must be inserted into the adapters for suction hose cleaning.

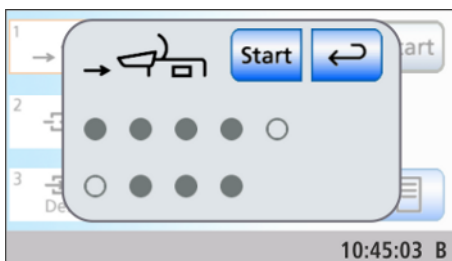

- ✓ Sanitization phase 1 is highlighted on the touchscreen.
  - ✓ The *Insert instruments in water unit* display appears on the touchscreen.
1. Detach the Sprayvit M sleeves from the valve bodies, the straight and contra-angle handpieces from the instruments that can be sanitized, and the suction tips from the suction hoses.

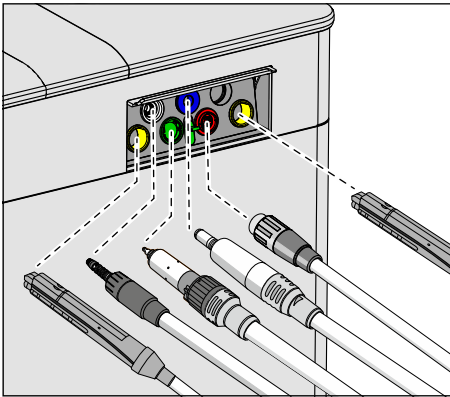

2. Dentist element side: Insert the couplings of all water-carrying treatment instruments into the sanitization adapters in the water unit (for Sprayvit M: valve lever in the up position, locking knob in the down position).  
Additionally for Sinius CS: Move the swivel arm of the instruments to be purged into the operating position so the weight of the instrument hoses keeps them in this position.

### IMPORTANT

#### Colors of the sanitization adapters

The sanitization adapters for the instrument couplings are color coded:

Yellow on left = Sprayvit M of the assistant element

Yellow on right = Sprayvit M of the dentist element

White = turbine

Green = BL motor

Blue = BL ISO E/C motor (ISO interface)

Red = SiroSonic TL scaler

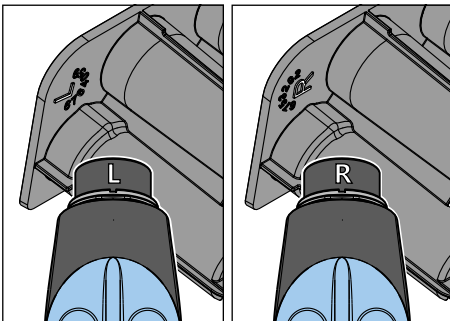

### IMPORTANT

#### Water button of the Sprayvit M

Depending on the position of the Sprayvit M water button, the removable sanitization cartridge is marked on the back. When the nozzle is taken from the holder, this mark can also be seen on the Sprayvit M. If the water button is on the right, the marking is an "R", for the Sprayvit M with water button on the left "L". The marking on the removable sanitization cartridge must match that on the Sprayvit M.

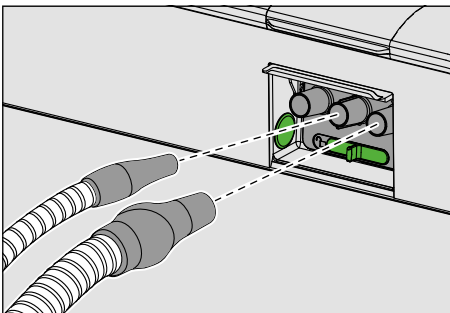

3. Assistant element side: Attach the suction hoses.

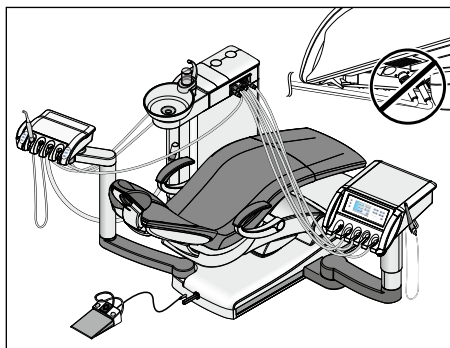

### IMPORTANT

#### Pinching the instrument hoses

Be careful not to pinch the instrument hoses when inserting the instruments.

If the hoses are pinched, the water flow will be obstructed during purging.

- ↪ The sanitization adapters for the water-carrying instruments and adapters for the suction hoses are all in use.



4. Touch the *Start* key on the touchscreen.

Sanitization can be started only if at least one instrument is removed from the holder.

### Sanitization phase 2 – Checking the water flow

The treatment center checks whether there is water flow through the instruments.

- ✓ Sanitization phase 2 is highlighted on the touchscreen.
- > Wait briefly until the water flow has been checked.
  - ↳ If sufficient water flow is present, the treatment center continues with sanitization phase 3.

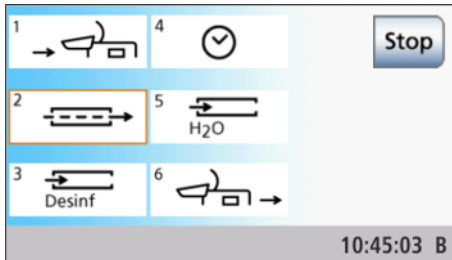

### Error message: No water flow

If the treatment center detects no water flow through an instrument or through the tumbler filler, you can try to restore water flow. If this is not possible, the instrument concerned can be excluded from the sanitization process.

1. Check the water flow through the instruments in the instrument positions marked with a warning triangle on the touchscreen. Set the instruments to maximum water flow. Keep the instruments plugged into the water unit.
  - ↳ If the treatment center detects the water flow, the warning triangle will disappear. If there is sufficient water flow through all instruments, sanitization phase 3 automatically continues.
2. If you want to exclude the instruments concerned from sanitization, touch the *Exclude instrument* key.
  - ↳ The treatment center continues with sanitization phase 3. The water paths you excluded are not included in the sanitization process.

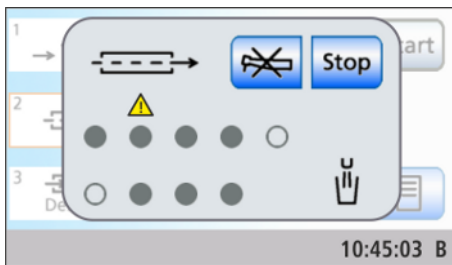

If it is impossible to restore the flow to the tumbler filler, sanitization is not possible. The tumbler filler cannot be excluded from the sanitization process.

### Sanitizing phase 3 - Treating the water paths with the agent for disinfecting the water paths

The water is pumped out of the water tank of the water unit using the tumbler filling function. Then the water tank is automatically filled with the undiluted disinfectant for the water paths. The instrument hoses, the Sprayvit M hoses, and the tumbler filler are then rinsed with the disinfectant. The suction hoses are cleaned.

#### NOTE

Splashes of undiluted disinfectant for sanitizing the water paths can result in discoloration of surfaces if left for too long.

Any splashes should therefore be removed immediately using a moist cloth.

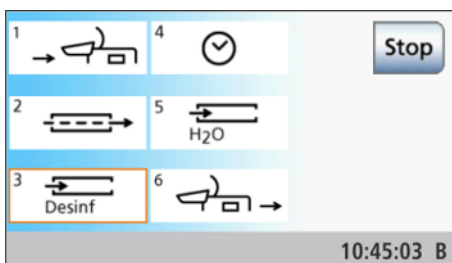

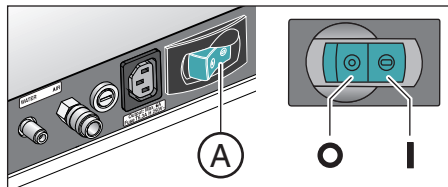
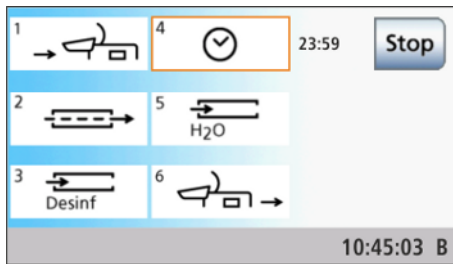

### Sanitization phase 4 – Allow 24 hours reaction time

In order to effectively combat bacteria, you must let the disinfectant for the water lines react for at least 24 hours but not longer than 3 days (maximum sanitization time).

- ✓ Sanitization phase 4 is highlighted on the touchscreen.
  - ✓ The treatment center displays the remaining reaction time on the touchscreen next to the sanitization phase 4 field, starting from 24 hours.
  - ✓ The treatment center has automatically switched to standby mode.
1. Leave all instruments plugged into the water unit.
  2. Make sure that the treatment center is switched off for at least 24 hours, but not longer than 3 days (maximum sanitization time). If necessary, you can also turn off the power switch on the base of the treatment center patient chair.

#### IMPORTANT

##### Blocking water and air supply

If the treatment center is turned on again after 24 hours, then sanitization phase 5 continues automatically. However, if the water and air supplies are blocked, the agent for disinfecting the water paths cannot be rinsed out of the water paths.

Switch the treatment center back on after 24 hours only when the water and air supply lines are open.

3. Empty the rinsing tumbler and return the empty tumbler below the tumbler outlet.
4. Switch the treatment center on again after 24 hours and before 3 days have elapsed.

##### Error message: Insert instruments in water unit

If an instrument is accidentally deposited in its holder during the reaction time, the message *Insert instruments in water unit* is displayed on the touchscreen after the treatment center is switched on. Sanitization is then completed anyway.

1. Take the accidentally removed instrument out of the instrument holder and place it back in the sanitization adapter on the water unit so that it can be purged in sanitization phase 5.
2. If you want to exclude the instruments from sanitization, touch the *Exclude instrument* key.
  - ↳ Excluded instruments will not be rinsed in sanitization phase 5.



### Sanitization phase 5 – Rinsing water paths with water

The disinfectant for the water lines is purged from the instrument hoses, Sprayvit M hoses, and tumbler filling unit with water. This takes several minutes.

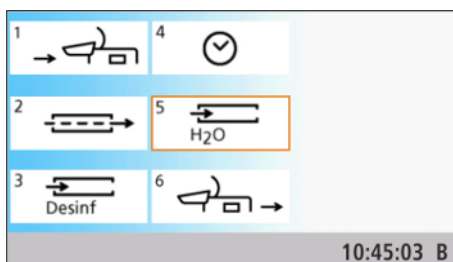

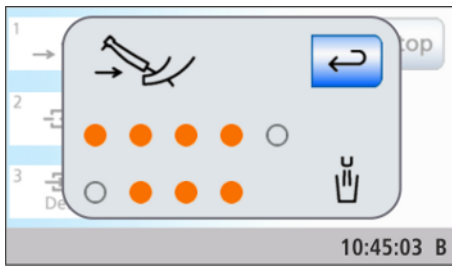

### Sanitization phase 6 – Returning the instruments to their holders

After the water lines have been purged, the instruments and suction hoses can be removed from the water unit bowl and returned to their holders.

- ✓ The *Return instruments to their holders* display appears on the touchscreen.
- Place the Sprayvit M sleeves, the straight and contra-angle pieces, and the suction tips back on the instruments or suction hoses. Return all instruments and suction hoses to the instrument holders.
  - ↪ The sanitization process is finished. The treatment center is again ready for operation.

### Messages for incomplete sanitization

The sanitization program detects whether the sanitization of all instruments and the tumbler filling was completed. Errors that occurred during sanitization will be displayed on the touchscreen as follows:

- Crossed-out, solid gray circle: The instrument was excluded from sanitization before it had been filled with the disinfectant for the water paths.
  - Orange circle with warning triangle: The instrument or tumbler filling was not (sufficiently) purged, the disinfectant for the water paths is still present in the water paths.
- In the latter case, rinse the affected instruments and tumbler filling manually after sanitization.

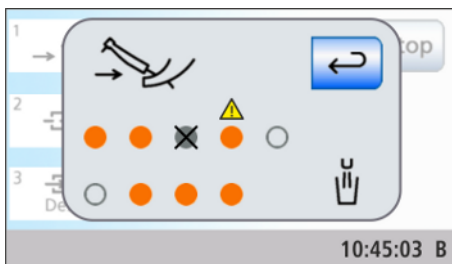

### Canceling the sanitizing process

Sanitization can be canceled during some sanitization phases, e.g. if the treatment center must be switched back on before the 24 hours have expired. The *Stop* key shows whether cancellation is possible.

- ✓ The sanitizing process has started.
- Touch the *Stop* key on the touchscreen.
  - ↪ The sanitizing process is canceled. If the water paths have not yet been treated with the agent for disinfecting the water paths (prior to sanitization phase 3), the treatment center automatically proceeds directly to sanitization phase 6. If the sanitization process is canceled during the reaction time, the water paths are initially rinsed with water (sanitization phase 5).



### 5.6.2 Display sanitization report

Sanitization processes with interactive guidance, with a reaction time of at least 24 hours, are logged by the treatment center. The corresponding log reports can be displayed on the touchscreen.

- ✓ The *Sanitization program* is displayed on the touchscreen.
- Press the *Sanitization program* key to display the log.
  - ↪ The sanitization report is displayed.



	AE					ASE				
	1	2	3	4	5	1	2	3	4	
2	+	+	+	-	-	-	-	+	-	06.02.2010 00:12
3	+	+	+	-	-	+	+	+	-	07.02.2010 17:01
4	+	+	+	-	-	-	-	-	-	08.02.2010 09:27
5	+	-	+	+	+	+	+	+	-	09.02.2010 01:54
6	+	-	+	+	+	+	+	+	+	10.02.2010 18:43
7	+	-	+	+	+	+	-	-	+	11.02.2010 11:05
.....										

10:45:03 B

The sanitization report contains the following data:

Column	Description
1	Sequential number
2	Status of sanitized instruments in dentist element, holder 1 to 5
3	Status of sanitized instruments in assistant element, holder 1 to 4
4	Date of sanitization
5	Time

The status of column 3 and 4 can assume the following values:

+ = successful sanitization

- = Sanitization was not completed (e.g., interruption)

### 5.6.3 Sanitizing the treatment center manually

#### IMPORTANT

The sequence for manual sanitization described below is feasible only if the treatment center is operated with a self-sufficient water supply.  
If the disinfection system is set for operation with public drinking water supply, the sanitization must be guided via the "Sanitization" dialog box, see "Interactively guided sanitization of the treatment center" [→ 264].

When operating with a self-sufficient water supply, sanitization is to be carried out manually:

- if the self-sufficient water supply takes more than 28 days, in exceptional cases
- After longer periods of disuse (> one week)
- If the germination index exceeds 100 germs per milliliter, see "Microbiological water test" [→ 204].

Manual sanitization is not documented in the sanitization report, see "Display sanitization report" [→ 270].

Sanitization takes at least 24 hours.

#### NOTE

**Additional devices connected to the external device connection must not be sanitized with the treatment center.**

The additional devices could be damaged. Residues of the agent for disinfecting the water paths can remain in the additional devices.

- Disconnect any additional devices from the treatment center prior to sanitization.

#### Preparation

The following preparations should be made prior to beginning sanitization.

1. If your treatment center is equipped with a cuspidor, activate the cuspidor flushing for at least one minute. This flushes the water paths.
2. Set all bur drives and the SiroSonic TL scaler to the maximum water flow rate.
3. Put all instruments and suction hoses in their holders.
4. Do **not** remove the tumbler holder from the cuspidor. Put an empty glass with a volume  $\geq 200$  ml under the tumbler outlet to prevent discoloration from the disinfectant for the water lines.

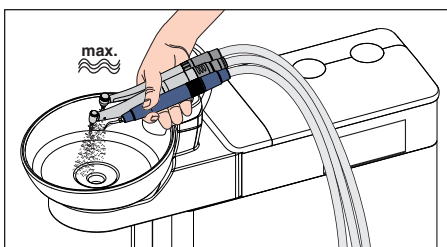



### Emptying the disinfectant tank and mixing tank

Before manual sanitization, the disinfectant tank and mixing tank must be emptied using the Sprayvit M.

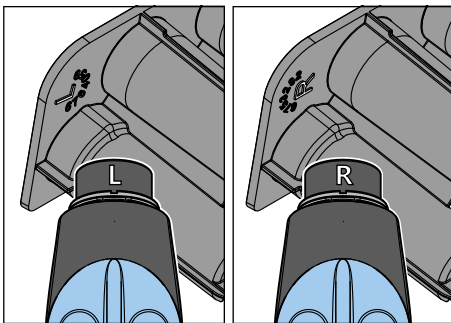
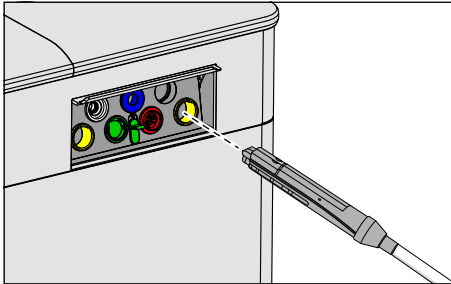

1. Remove the Sprayvit M on the dentist element from the instrument holder. Remove the Sprayvit M sleeve from the valve body and connect the valve body into the sanitization adapter of the water unit (valve lever up, locking button down).  
Additionally for Sinus CS: Move the swivel arm of the Sprayvit M into the working position so the weight of the instrument tube holds it in this position.

#### IMPORTANT

##### Water button of the Sprayvit M

Depending on the position of the Sprayvit M water button, the removable sanitization cartridge is marked on the back. When the nozzle is taken from the holder, this mark can also be seen on the Sprayvit M. If the water button is on the right, the marking is an "R", for the Sprayvit M with water button on the left "L". The marking on the removable sanitization cartridge must match that on the Sprayvit M.

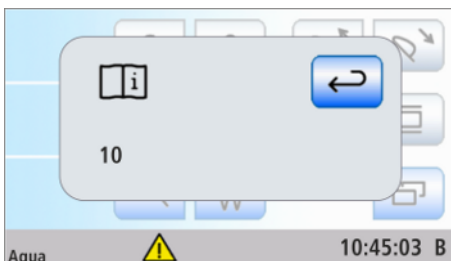

2. Wait until no more water flows from the Sprayvit M. This can take up to 12 minutes. Press the tumbler filling several times to speed up the process.  
  - ↳ A warning triangle appears in the status bar of the touchscreen. After pressing the warning triangle, the error code 10 is displayed ("Flow in the Sprayvit M on the dentist element too low"). This message confirms that the disinfectant tank and mixing tank are empty.
3. Switch off the treatment center via the user interface and return the Sprayvit M valve body to the instrument holder.

### Treating the water lines with disinfectant for water lines

The water lines of the instrument hoses, Sprayvit M hoses, and the tumbler filler are filled with the undiluted disinfectant for the water lines.

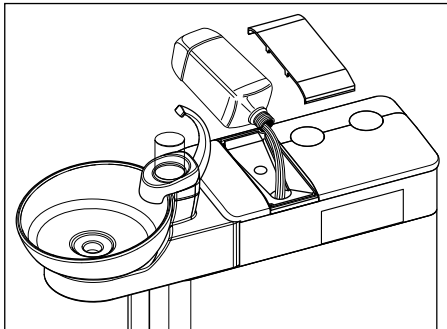

1. Fill approx. 0.6 liters of disinfectant into the disinfectant tank.

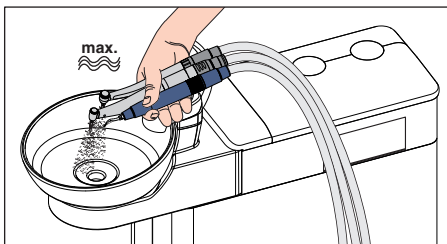

2. Switch the treatment center on via the user interface and wait approximately 3 minutes until the treatment center is ready for operation.
3. Remove the instruments one after the other from the holder and hold them over the cuspidor or over a watertight container with sufficient capacity. Activate each instrument for approximately 15 seconds. Then return the instruments to their holders. Also with the Sinus CS: Move the swivel arm of the instruments to the working position.
4. Empty the rinsing tumbler and return the empty tumbler below the tumbler outlet.
5. Press the tumbler filler three times.

#### NOTE

Splashes of undiluted disinfectant for sanitizing the water paths can result in discoloration of surfaces if left for too long.

Any splashes should therefore be removed immediately using a moist cloth.

### Allow 24 hours reaction time

In order to effectively combat bacteria, you must let the disinfectant for the water lines react for at least 24 hours but not longer than 3 days (maximum sanitization time).



1. Switch off the treatment center via the user interface, not via the power switch on the base of the patient chair. Make sure that the treatment center is switched off for at least 24 hours, but not longer than 3 days (maximum sanitization time).
2. Switch the treatment center back on after the reaction time.

### Purging disinfectant for the water paths from the water paths

After the reaction time, the remaining disinfectant for the water lines must be flushed out of the mixing tank using the Sprayvit M.

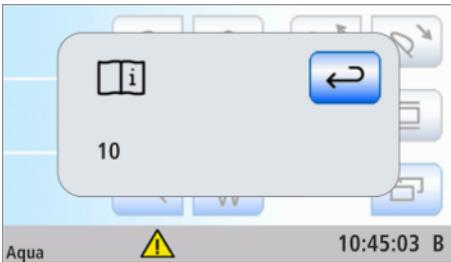
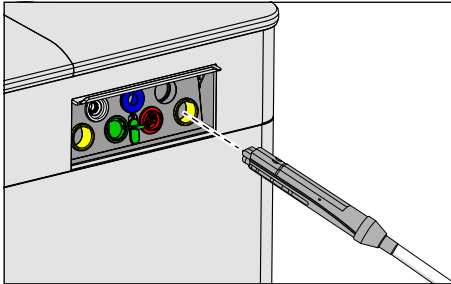

1. Insert the Sprayvit M valve body on the dentist element into the sanitization adapter of the water unit as described above. Wait until no more water flows from the Sprayvit M.

⚠ The warning triangle with error code 10 ("Flow at the Sprayvit M on the dentist element too low") appears again in the status bar of the touchscreen. The remaining disinfectant for the water lines has now been rinsed out.

2. Remove the Sprayvit M valve body from the water unit and reattach the Sprayvit M sleeve. Return the Sprayvit M to the instrument holder.

### Purge water lines with water

The disinfectant for the water paths is rinsed out of the instrument hoses, Sprayvit M hoses, and tumbler filling unit with water.

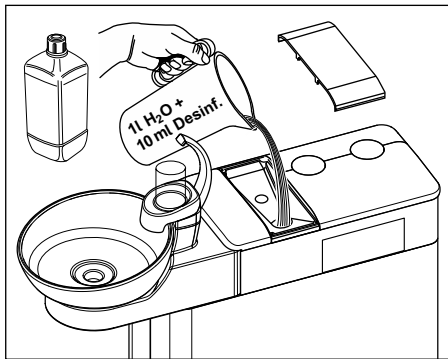

1. Mix distilled water with the agent for disinfecting the water paths in a ratio of 100:1 (1 liter of water, 10 ml of the agent) and fill this into the disinfector tank of the water unit. Then wait approx. 2 minutes.
2. Hold the instruments over the cuspidor or over a watertight container with sufficient capacity again and thoroughly rinse all the instruments for approximately 30 seconds.
3. Empty the rinsing tumbler and return the empty tumbler below the tumbler outlet.



4. Press the tumbler filler three times.
- ⚠ The manual sanitization process is finished. The treatment center is again ready for operation.

### Clean the suction hoses

After the manual sanitization, all suction hoses should also be cleaned.

- If the treatment center is equipped with the chemical suction hose cleaning option, see "Cleaning the suction hoses" [→ 241].
- If the treatment center is not equipped with the chemical suction hose cleaning option, see "Cleaning the suction system using the suction hose adapter for the cuspidor or via an external tank" [→ 243].

#### 5.6.4 Biofilm removal by the service technician

If the microbiological test of the water from the treatment center does not correspond with the hygiene requirements in spite of regular sanitization of the water paths and/or regular purge/autopurge cycles, the biofilm must be removed using special chemicals.

Biofilm removal should be performed if the bacterial count is significantly above 100 colony forming units per milliliter.

Biofilm removal may only be done by a trained service technician. In this case, please contact your dental depot.

Before initiating biofilm removal it must be ensured that the reason for the raised bacterial count is not due to inflowing water.

## 5.7 Foot control and connection box

### 5.7.1 Changing the battery of the wireless foot control



10:45:03 B

The wireless foot control is powered by a battery. An empty battery is detected and displayed by the system. The battery can be changed by the user.

For the battery type, see "Spare parts and consumables" [→ 285].



- > Switch the treatment center off at the standby switch before changing the battery. This prevents the inadvertent triggering of unwanted functions.

For older wireless foot controls, the housing must be unscrewed to change the battery. Newer models have a battery compartment:

#### Removing and replacing the battery (without battery compartment)

The housing of the wireless foot control must be opened to change the battery. Touch a grounded metal part before opening the housing to prevent damage to the PC board due to electrostatic discharge.

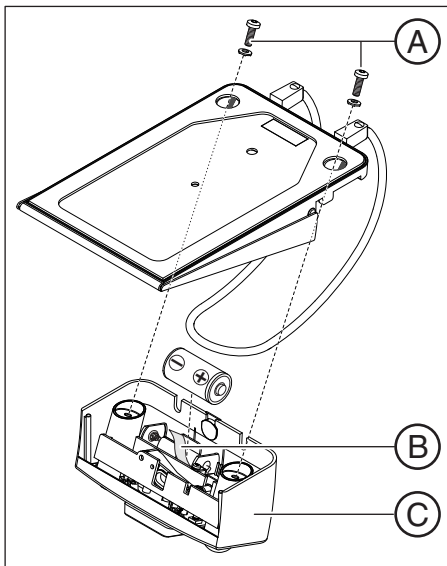

1. Remove the screws **A** from the bottom of the foot control.
2. Remove the switch part **C** from the foot control.
3. Pull the battery out of the battery compartment by pulling the cloth strap **B** and replace it with a new one. Be careful to insert them with the correct polarity (minus pole facing spring). The cloth strap **B** must again lie underneath the battery.
4. Note the blink signal of the LED after replacing the battery, see "Check battery" (step after next).
5. Mount the switch part **C** on the foot control to reassemble the foot control.
6. Remove the screws **A** from the bottom of the foot control.

#### IMPORTANT

##### Putting the wireless foot control back into operation

After changing the battery, start the treatment center and check the complete functionality of the foot control.

It is **not** necessary to register the foot control again at the treatment center after changing batteries.

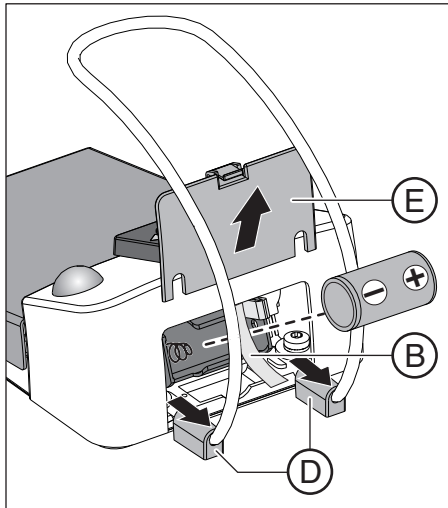

### Replacing the battery (with battery compartment)

1. If the adjustable feet **D** sit close to the battery cover **E**, slide this small part outward.
2. Open the battery cover **E**.
3. Pull the battery out of the battery compartment by pulling the cloth strap **B** and replace it with a new one. Be careful to insert them with the correct polarity (minus pole facing spring). The cloth strap **B** must again lie underneath the battery.
4. Note the blink signal of the LED after replacing the battery, see "Check battery" (step after next).
5. Close the battery cover **E**.

#### IMPORTANT

##### Putting the wireless foot control back into operation

After changing the battery, start the treatment center and check the complete functionality of the foot control.

It is **not** necessary to register the foot control again at the treatment center after changing batteries.

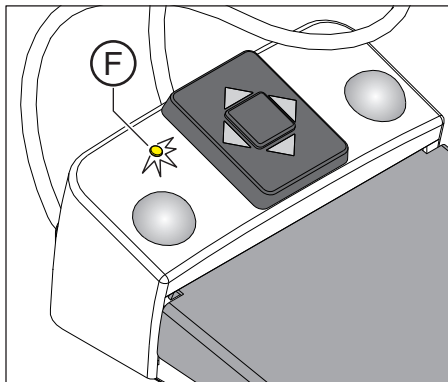

### Checking battery charge

The battery status is indicated by the yellow LED **F** in the switch part.

- LED lights up for approx. 10 s after battery is inserted – Battery OK
- LED flashes after battery is inserted – Battery too weak, must be replaced
- LED does not light up – Battery empty, must be replaced

### Battery disposal



To protect the environment, batteries may not be disposed with household garbage. Please observe the applicable national regulations for battery disposal.

## 5.7.2 Changing the fuse of the external device connection

The IEC outlet socket remains live even when the power switch is turned off. The fuse can nevertheless be changed.

To reorder the fuse, see "Spare parts and consumables" [-> 285].

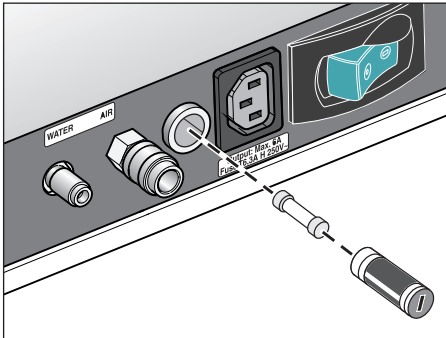

- ✓ The IEC outlet socket is not supplying any power.
  - 1. Pull the plug of the connected device out of the IEC outlet socket.
  - 2. Use a screwdriver to unscrew the fuse sleeve.
  - 3. Replace the fuse (T 6.3 A, 250 VAC) and screw the fuse sleeve back in.
  - 4. Reconnect the external device to the IEC outlet socket.
- ⚠ If the inlet connect still is not supplying any power, contact the manufacturer of the connected device or your local distributor.

## 6 Maintenance by the service engineer

### 6.1 Inspection and maintenance

In order to ensure the operational safety and reliability of your treatment center and to avoid damage due to wear and tear, **annual** inspection and maintenance must be performed on your treatment center. This is done by an authorized service technician from your dental depot.

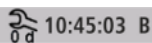

As soon as the next maintenance call is due in less than 42 days, a wrench symbol appears in the status line of the touchscreen after switch-on. Below this symbol, the number of days until the maintenance deadline are counted down (e.g. 13 d = 13 days). You should now contact your dental depot and make an appointment.

The treatment center should be cleaned and disinfected by the practice personnel before the maintenance deadline.

The work steps to be performed as well as the parts which must be replaced are specified in the document "Maintenance Log".

An overview of the inspection and servicing carried out is additionally recorded by the service technician in the "Maintenance Manual".

### 6.2 Safety checks

Medical equipment is designed in such a way that the first occurrence of a fault does not create a hazard to the safety of patients, users or other persons. It is therefore important to detect such faults before a second fault occurs, which might then lead to safety hazards.

#### **WARNING**

It is essential to perform safety checks **every 2 years** in which electrical faults (e.g. defective insulation) in particular can be detected. This is done by an authorized service technician from your dental depot. The treatment center must not be operated if it has failed to pass the safety tests!

The safety tests can be carried out in connection with work performed for "Inspection and maintenance" [→ 280].

Safety tests must also be performed and documented at initial startup, after extensions/upgrades (retrofitting) of your treatment center, and after repair work that could affect the electrical safety of the system.

The safety test includes a visual inspection as well as measurements of the protective ground wire connections and the equivalent leakage currents. The inspections and measurements to be performed are specified in the "Maintenance Manual". The measured values must be documented there by the service technician.



## 6.3 Maintenance Manual

Keep this Maintenance Manual near your treatment center.

Any inspection and maintenance work as well as all safety tests are documented by the service engineer in the Maintenance Manual.

We recommend to the user to always keep the documentation in the chapter "Reporting of incidents to authorities / manufacturers" up to date, regardless of any legal requirements.

## 7 Malfunctions

### 7.1 Error messages



Error states of the treatment center that cannot be immediately recognized by the user but must nevertheless be corrected are displayed on the touchscreen. If an error state exists, this is indicated by a warning triangle **A** in the status line of the touchscreen.

- > Touch the warning triangle **A** in the status bar of the touchscreen.
  - ↳ The error code(s) is(/are) displayed.

The error codes have the following meaning:

Code	Error	Description	Measure
10	Flow rate of Sprayvit M on dentist element too low	The water flow rate is below the limit value. The heater of the Sprayvit M is no longer heated to prevent scalding by overheated water.	Clean the outlet nozzle of the Sprayvit M, see "Instructions for use Sprayvit M" and perform the flow test, see "Checking the flow rate on the Sprayvit M multifunctional syringe" [→ 229].
11	Flow rate of Sprayvit M on assistant element too low		
12	Tumbler temperature fuse defective	The temperature fuse was blown by overheating. The water in the tumbler filling unit is no longer heated.	Inform your service technician.
13	Battery of wireless foot control empty	Operation of the treatment center no longer possible due to fully depleted battery.	See "Changing the battery of the wireless foot control" [→ 277].
14	Consumption of the agent for disinfecting the water paths too low	The disinfectant tank was not emptied since its last filling even though many disinfection cycles were performed.	Inform your service technician
15	Water supply too low	The maximum filling time for the mixing tank is exceeded.	Change the water filter, see "Changing the water and air filters" [→ 254]. Check the water pressure of the drinking water network.
17	Emergency pump operation	Malfunctioning of pump sensors in the water unit.	Inform your service technician.
18	Chair movement outside of the permissible movement limits or chair drive position not plausible	If the chair is located outside of the permissible movement limits or the position is not plausible, the chair stops moving.	Inform your service technician.
19	Injection valve for the agent for disinfecting the water paths defective	No agent for disinfecting the water paths will be added if the injection valve is defective.	Inform your service technician.

Code	Error	Description	Measure
21	The flushing tank is empty	It was detected that the flushing tank had not been filled. Flushing of the suction paths cannot be ensured.	Change the water filter, see “Changing the water and air filters” [→ 254]. Check the water pressure of the drinking water network. With a wet suction system, a restart is necessary following troubleshooting.
23	Apex locator	After switching on the treatment center, the apex self-test failed or an error occurred during the measurement.	Inform your service technician if the error occurs repeatedly. The mucosal electrode must not be used on the patient in this state.
24	Backup battery empty	The time and date are reset after the treatment center is switched back on.	Inform your service technician.
25	Wireless foot control is disturbed	Communication between the wireless foot control and the treatment center is interrupted. The instrument is stopped for the duration of the interruption.	After the foot pedal is pressed again, the instrument can be reactivated. If the error occurs repeatedly, switch off sources of interference, e.g. microwaves and WLAN.
26	Software inconsistency	An error must be acknowledged after the treatment center is switched on. The functions of the treatment center may be impaired.	Inform your service technician.
27	Suction hose cleaning	Too little water is used for suction hose cleaning.	Inform your service technician. Instead, suction a glass of water regularly.
31	Chemical suction hose cleaning	The cleaning agent tank for chemical suction hose cleaning has not been emptied since the last filling despite several suction hose cleanings.	Inform your service technician.
33	Cuspidor bowl valve	The water container of the cuspidor valve is not emptied. The tumbler filling, flushing, suction hose cleaning, sanitization, purge and autopurge functions cannot be activated.	Check whether the suction device is switched on. Inform your service technician.
34	LEDview Plus	The operating light has excessively overheated. It can no longer be operated at full brightness. In the event of further heating, the light will switch itself off.	Protect LEDview Plus against strong sunlight. Switch the treatment center off and on again. For further details please refer to LEDview Plus instructions for use, section “Faults”.
35	Chair positioning defective	The target positions of the motor-driven headrest or sliding track are possibly not reached.	Inform your service technician.

The warning triangle automatically disappears as soon as the error state has been eliminated. If it does not disappear, please inform your service engineer.

## 7.2 Remote diagnosis

- Functional description** With remote diagnosis, you enable the staff of your dental depot or our Customer Service Center, see "Contact data" [→ 10], to connect to the PC of your treatment center. The contents of your PC monitor are then transmitted to the computer of the service specialist and remote access to your PC is enabled.
- Advantages** This offers you the following advantages:
- Fast support through remote access
  - Remote diagnosis via readout of error codes
  - Effective help during the application
  - Fewer service calls by service engineers due to remote diagnosis
  - Shorter downtimes
- Prerequisites** In order to utilize remote diagnosis, your treatment center must be connected to a PC. In addition, the PC must have Internet access.
- Remote access to your PC is established via a remote access software. Various different software applications can be used for remote access. Please contact your service engineer for more information.
- Safety aspects** During a remote access session, you as the customer can cancel the service specialist's remote control rights at any time, thus blocking further remote access. You thus always remain in control during remote access.
- Extensive security and access protection functions protect your PC against alterations, spying and manipulations. These options will vary depending on the remote access software involved. In general, remote controlled access can be monitored directly by the customer. By setting the access rights, you as the customer can determine which activities service specialists will be allowed to perform via remote access. All other functions which have not been approved by you remain disabled for the service specialist.
- If you have any further questions, please contact your dental depot or our Customer Service Center; see "Contact data" [→ 10].

## 8 Spare parts and consumables

Use only original spare parts and original consumables from Dentsply Sirona!

Please order the materials listed below from a specialized dental dealer.

### Care, cleaning, and disinfecting agents

A continuously updated list of approved agents can be downloaded on the internet from the online portal for technical documents. You can reach this portal at the address:

[www.dentsplysirona.com/manuals](http://www.dentsplysirona.com/manuals)

Click on the menu items "General documents", "All products" and then open the "Care, cleaning and disinfection agents" document (REF 59 70 905).

### Treatment center

Total count tester	58 53 775
Air and water filters	14 43 436
Amalgam rotor	14 34 138
Peristaltic pump hose set (5 pcs)	66 25 953
Oil collector for Sinius CS dentist element	63 31 180
Spray aspirator with additional air intake, saliva ejector A spray aspirator as well as a saliva ejector from the Dürer Dental company is attached to the treatment center on delivery. They can be ordered from a specialized dealer.	–
Suction hose cleaning cartridge triple	67 53 391
Autopurge/sanitization cartridge, water button on Sprayvit M right	67 53 409
Autopurge/sanitization cartridge, water button on Sprayvit M left	67 64 067
Turbine sanitization adapter	67 66 872
Motor BL sanitization adapter	67 66 880
Motor ISO sanitization adapter	67 66 898
SiroSonic TL sanitization adapter	67 66 856
Ball stopper For sealing the instrument holder of the Sinius TS and Sinius dentist elements	58 99 575
Fuse for the external device connection 100 V – 240 V~ (T 6.3 A, 250 V~)	10 77 452
Battery for wireless foot control 1x type alkaline baby (C or LR14) with 1.5 V (commercially available) Always use high-quality batteries!	52 52 002

**Multifunctional syringe Sprayvit M**

Sprayvit nozzle G, long, curved, with fiber optic	59 92 180
Casing, right water path	60 02 179
Casing, left water path	60 02 187
Keyboard	63 21 728
Small cleaning wires	24 00 232
LED	63 22 007
Heating cartridge	33 27 132
O-ring 1.5 x 1 for heating cartridge	70 41 734
O-ring set Sprayvit nozzle 1 x attachment tool and 10 x O-rings 5.5x1.03	41 76 751
Dentsply Sirona T1 Spray (6 x 250 ml cans)	59 01 665

**BL motor**

Halogen lamp	60 34 677
LED	63 14 558
Lamp ring	60 81 082
BL sealing washer, blue	62 24 484
ISO adapter	60 00 793
Basic Apex adapter	59 83 072

**BL ISO C motor**

BL ISO C motor sleeve	63 49 851
BL ISO C/E/S sealing washer, green	63 11 240
O-ring 8.4 x 0.7	58 60 390
T1 Spray (6 x 250 ml cans)	59 01 665

**BL ISO E motor**

BL ISO E motor sleeve	64 69 204
BL ISO C/E/S sealing washer, green	63 11 240
O-ring 8.4 x 0.7	58 60 390
T1 spray (6 x 250 ml cans)	59 01 665

**BL Implant motor**

BL Implant motor sleeve	62 42 734
BL Implant sealing washer, yellow	62 24 492
O-ring 8 x 1	70 36 189
O-ring 15 x 0.7 (5 pieces)	62 81 559
T1 spray (6 x 250 ml cans)	59 01 665

### ISO adapter / Basic Apex adapter

O-ring 8.4 x 0.7	58 60 390
O-ring 8 x 1	70 36 189
T1 spray (6 x 250 ml cans)	59 01 665

### Endodontics/implantology

Silicone insulation sleeve for endodontics with the ApexLocator (5 pcs)	63 24 631
Peristaltic pump hose set (5 pcs)	62 25 903
Hose clamp for saline hose (recommended quantity: 5)	89 28 392
Separate motor holder for implantology motor	59 99 821

## 9 Disposal



In accordance with Directive 2012/19/EU and national disposal regulations regarding old electrical and electronic devices, please be advised that such items must be disposed of in a special way within the European Union (EU). These regulations require the environmentally friendly recycling/disposal of old electrical and electronic devices. Such items must not be disposed of as domestic refuse. This has been expressed using the icon of the “crossed out trash can”.

### Disposal procedure

We feel responsible for our products from the first idea to their disposal. For this reason, we give you an option to return our old electronic and electrical devices.

If you wish to dispose of your devices, please proceed as follows:

#### In Germany

To initiate return of the electrical device, please send a disposal request to enretec GmbH. You have the following options here:

- Use the ‘Returning an electrical device’ button under the ‘eom’ menu item on the enretec GmbH homepage ([www.enretec.de](http://www.enretec.de)).
- Alternatively, you can also contact enretec GmbH directly.

enretec GmbH  
Kanalstraße 17  
16727 Velten, Germany  
Phone: +49 3304 3919-500  
E-mail: [eom@enretec.de](mailto:eom@enretec.de)

In accordance with the national disposal regulations regarding old electrical and electronic devices (ElektroG), as the manufacturer, we assume the costs for disposing of the electrical and electronic devices in question. Disassembly, transport and packaging costs shall be borne by the owner / operator.

Prior to disassembly/disposal of the unit, it must be prepared professionally (cleaned/disinfected/sterilized).

If your unit is not permanently installed, it will be collected from the practice. If it is permanently installed, it will be picked up curbside at your address by appointment.

#### Other countries

For country-specific information on disposal, contact your local dental dealers.



## 9.1 Battery disposal

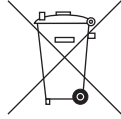

Note for disposal company

Prior to disposal, remove the following batteries from the treatment center:

- Battery in the wireless foot control
- Lithium battery on the **HSA** circuit board (REF 62 78 985) in the junction box of the chair.  
Remove the CR2032 button cell from the battery holder (BAT 1).

## 9.2 Disposal of disinfectants

Please see the respective safety datasheets for the products for information on disposal.

# 10 Overview of all function keys

The following contains a brief description of the fixed keys on the dentist and assistant elements and the function keys on the touchscreen and to provide the reader with a quick overview of the significance of the symbols on the keys. Detailed descriptions can be found in the corresponding sections of this document.

## 10.1 Fixed keys

### 10.1.1 Dentist element



#### Standby switch

Switches the treatment center on/off.

To switch off the treatment center, press and hold the key until an acoustic signal sounds. Then release the key.

#### IMPORTANT

##### Power switch

The treatment center also features a power switch on the base of the chair that separates the treatment center from the power supply, see "Switching the treatment center on/off" [→ 49].



#### Dialog change keys

The dialog change keys allow the user to switch between the main dialogs *Start dialog*, *Instrument dialog* and *Sivision dialog* in the *Standard start dialog* operating mode.



In the *EasyMode start dialog* operating mode, the dialog change keys *Chair* and *Instrument* can be used to switch to the relevant sub-dialogs.



#### Timer function

Opens the *Timer function* dialog where any of four preset timers can be activated. The elapsed time is displayed in the status bar of the touchscreen.

If the *Timer function* key is pressed (> 2 s), the settings dialog appears.



#### Shock positioning

Immediately moves the patient chair to a position for shock positioning of the patient.



#### Operating light

Switches the operating light on/off.

If the *Operating light* key is pressed for > 2 s, the settings dialog appears.



#### Composite function

Switches the composite function for the operating light on/off.

This function can delay the curing of composite materials.



### **Tumbler filling**

Starts or stops the tumbler filling function.

When the *Tumbler filling* key is pressed (> 2 s), the filling time and water heating settings dialog appears.



### **Cuspidor flushing**

Starts or stops cuspidor flushing.

When the *Flushing* key is pressed (> 2 s), the *Flushing Time* settings dialog appears.



### **Freely selectable function**

e.g., call key

Freely available relay 230 VAC, 6 A  
(connected by the service engineer).

This function can be preset as a button or as a switch in the Setup dialog.



### **Freely selectable function**

Freely available relay 230 VAC, 6 A  
(connected by the service engineer).

This function can be preset as a button or as a switch in the Setup dialog.

Clean

### **Clean key**

Pressing this key deactivates the complete user interface of the dentist element with the exception of the standby switch. Pressing it again > 3 s reactivates the user interface.

This is used to make sure that no unwanted functions can be accidentally triggered while cleaning the surface.

Setup

### **Setup key**

Used for individual configuration of the treatment center by the user and for reading out messages by the service technician, see "Configuration of the treatment center (Setup)" [→ 191].

### 10.1.2 Assistant element



#### Tumbler filling

On/Off



#### Cuspidor flushing

On/Off



#### Operating light / Composite function

Switches the operating light on, to the composite function, or off.  
The composite function delays the curing of composite materials.

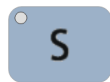

#### Chair program S

Mouth rinsing position with last-position memory function (programmable)



#### Chair program 0

Entry/exit position (programmable)















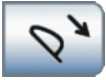















#### Freely selectable function

The *Hash key* on the assistant element can be configured in the Setup dialog. The key allows the user to switch the X-ray viewer or the white screen function on the Sivation monitor on or off or alternatively to activate the bell or hash relay.

Freely available relay 240 VAC, 6 A  
(connected by the technician)

## 10.2 Start program

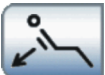
- |   |  |   |
|---|--|---|
|    | <b>Chair program S</b><br>Mouth rinsing position with last-position memory function (programmable) |   |
|    | <b>Chair program 0</b><br>Entry/exit position (programmable)                                       |   |
|    |                   | <b>Chair programs 1 and 2</b><br>(programmable)   |
|    |                   | <b>Moving the headrest in/out</b><br>if a motor-driven headrest is installed  |
|    |                   | <b>Inclining the headrest</b><br>if a motor-driven headrest is installed  |
|    |                   | <b>Tilting the patient couch</b><br>Compensated motion of the seat and backrest without any compression or stretching effects for the patient |
|   |                  | <b>Adjusting the chair height</b>   |
|   |                 | <b>Selecting a user profile</b><br>A stored user profile can be selected for up to six different users (A to F).                              |
|  |                 | <b>X-ray viewer</b><br>Also white screen on Sivision monitor for Sivision Digital   |
|   |                 | <b>Open manual chair setting screen</b><br>For the <i>Standard Start program</i> operating mode only  |
|   |                 | <b>Treatment function</b><br>Activation of the endodontics treatment function   |
|   |                 | <b>Opening the sub-screen</b><br>Used to access additional subordinate functions; see the following function keys:                            |
|   |                 | <b>Purging water paths</b><br>Starts the purge function   |
|   |                 | <b>Purging water paths automatically</b><br>Starts the autopurge function   |
|   |                 | <b>Sanitizing</b><br>Starts the treatment center sanitation program   |

-  **Stand-alone water supply**  
The disinfection system switches to self-sufficient water supply
-  **Extracting residual water**  
Extraction of residual water by standard wet suction before cleaning the filter
-  **Apex measurement with file clamp**  
Activation of the ApexLocator for manual measurement with the file clamp, showing the distance display
-  **Apex distance acoustic signals**  
Activates the acoustic signals for the distance to the apex. The intervals between the acoustic signals vary according to the measured distance to the apex.
-  **External HF surgical device**  
Activation of the protection against interference caused by an external HF surgical unit
-  **Sprayvit M instrument light**  
Switches the instrument light of the Sprayvit M removed from the holder on/off.
-   **Active lumbar support**  
Adjustment of active lumbar support

## 10.3 Instrument program



### Static speed quick setting keys

Setting preset or intermediate speeds

BL, BL ISO C and BL Implant motors: min. 90 rpm, max. 40,000 rpm  
BL ISO E motor: min. 2000 rpm, max. 40,000 rpm



### Static intensity quick setting keys

Setting preset or intermediate intensity values for the SiroSonic TL scaler

In the *EasyMode Start program* operating mode, the speed, intensity, and endodontics function for the SiroSonic TL scaler can be set only using the intensity quick setting keys.

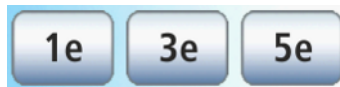

### Static quick setting keys for the endodontics function

Setting preset or intermediate endodontics intensity values for the SiroSonic TL scaler with activated endodontics function



### Programmable speed quick setting keys

Adjusts and saves the speed of the electric motor and also preselects and activates the coolant

BL, BL ISO C and BL Implant motors: min. 90 rpm, max. 40,000 rpm  
BL ISO E motor: min. 2000 rpm, max. 40,000 rpm



### Programmable intensity quick setting keys

Adjusts and saves the intensity of the SiroSonic TL scaler and also preselects and activates the coolant



### Memory key

Used to save instrument settings

This key is displayed only in the Save mode. Storage occurs automatically when the instrument is deposited in the Drop mode.



### Function levels

Storage and selection of instrument settings at two levels



### Direction of rotation

Switches counterclockwise rotation ON/OFF

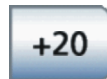

### Boost function

Increases the intensity setting of the SiroSonic TL scaler in steps of 20, referenced to the final value during treatment. After an intensity of 80 is reached, only the maximum value of 100 can be selected.

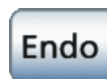

### Endodontics function

Activation of the endodontics function for the SiroSonic TL scaler (power limitation)



### Chip blower

Used to dry treatment areas or blow off drilling chips by emitting air blasts from the treatment instrument

This key is displayed only when cursor control is activated



#### Activate preselected coolant

The coolants to be available for selection in the Instrument program can be set in the sub-screen of each individual instrument, see below.

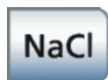

#### Sub-screen

Used to access additional subordinate functions; see the following function keys:



#### Preselecting spray coolant

Used to cool the treatment area with spray



#### Preselecting air coolant

For cooling the treatment area with air



#### Preselect NaCl coolant

For cooling the treatment area with sterile saline solution



#### Setting the automatic motor stop of the ApexLocator

Switching the motor stop function of the ApexLocator on or off. When the *Apex Stop* key is pressed, the *Auto-Reverse* key is displayed. If the motor stop function is activated, the motor stops automatically when the physiological apex is reached.

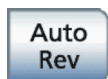

#### AutoReverse

Switching the ApexLocator Auto-Reverse function on or off. When the physiological apex is reached, the bur drive automatically switches to counterclockwise rotation when reactivated by the foot control. When the file is withdrawn, the bur drive automatically switches back to clockwise rotation.



#### Instrument light

Activates and sets the instrument light



#### Direct starter / speed foot control

Direct starter (highlighted gray): Switches the instrument on at the set speed or intensity  
Regulating foot switch (highlighted orange): Controls instrument up to the maximum set speed or intensity depending on the position of the the foot switch pedal.



#### Apex acoustic signals

Switching the apex acoustic signals on/off. If the signal tones are switched on, a beep is issued when the apex or a set motor stop position is reached. If the Auto-reverse function is activated, three acoustic signals are issued when the motor switches to counterclockwise rotation.





### Apex distance acoustic signals

Switching the apex distance signal tones on or off. The intervals between the signal tones vary according to the measured distance to the apex.

## 10.4 Treatment program

### 10.4.1 Treatment selection



#### Assigning the bur drive

A bur drive must be assigned to each treatment type, i.e. endodontics and implantology.



#### Display of assigned bur drive

The assigned bur drive is marked with an orange circle. Any position marked with a gray circle also can be assigned.



#### Open endodontics administration

Used to access additional subordinate functions for endodontic treatments; see "Endodontic administration" [→ 298].

### 10.4.2 Endodontics



#### Calibrating the bur drive

A calibration must be performed each time you change or lubricate the contra-angle handpiece.

The contra-angle handpiece is automatically checked during calibration. This includes a measurement of motor current at different speeds to assess the properties of the system.



#### Direction of rotation

Switches counterclockwise rotation ON/OFF



#### Opening the sub-dialog

Used to access additional subordinate functions; see the following function keys:



#### Setting the automatic motor stop of the ApexLocator

When the *Apex Stop* key is pressed, the – and + keys are displayed. The automatic motor stop can be switched off or set to four different levels. If the distance is 0, the motor does not stop until it reaches the physiological apex. Please note that the distance values are not a metric length measurement!

The preset motor stop position is displayed as a black triangle to the right of the distance display under the text "Stop".

Auto  
Rev

#### AutoReverse function

When the set torque value is reached, the bur drive automatically switches to counterclockwise.

If your treatment center is equipped with the ApexLocator option, the bur drive stops automatically when the set motor stop position is reached. If the auto-reverse function is switched on, the next time the foot pedal is activated following a motor stop, the motor is switched to counterclockwise rotation. When the root canal file is withdrawn, the bur drive automatically switches back to clockwise rotation.



#### Remove file from sequence

Deletes the selected files from the sequence.



#### Memory key

Stores the settings of an endodontic treatment

### 10.4.3

## Endodontics administration



#### Opening the sub-dialog

Access from the *Treatment selection* program. See the following function keys:



#### Copy endodontic treatment

A treatment can be copied and saved in the treatment list under a different name. Then the settings can be changed.



#### Rename endodontic treatment

Endodontic treatments can be renamed to facilitate corrections and editing.



#### Delete endodontic treatment

Removes individual endodontic treatments from the treatment list.



#### Adding a file system

For importing stored file systems to the endodontic treatment list.

## 10.5 Other dialogs

### 10.5.1 Timer screen



#### Timer keys

Up to four timers can be set. The maximum time setting is 9 minutes and 30 seconds.



#### Time loop

If the key is highlighted orange, the countdown will automatically be restarted when the set time has expired.



#### Acoustic signal

If the key is highlighted orange, an acoustic signal will sound when the set time has expired.

### 10.5.2 Sprayvit M setup



#### Activating/deactivating and setting the water tempering

### 10.5.3 Tumbler filling settings screen



#### Link tumbler filling to mouth rinsing position

If the key is highlighted orange, the tumbler filling function will automatically be switched on for the duration of the preset filling time when the mouth rinsing position chair program (S) is activated.



#### Water tempering on/off



#### Set filling time

### 10.5.4 Flushing settings screen

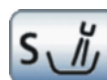

#### Linking flushing to mouth rinsing position S

Following movement to mouth rinsing position S, the flushing function automatically switches on for the duration of the set flushing time.

### 10.5.5 Operating light setting program



#### Sensor control for switching the operating light on/off

If the key is highlighted orange, the operating light can be switched on/off or changed to the Composite function by a hand movement.

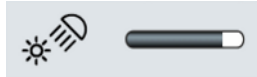

#### Setting the brightness of the operating light



#### Setting the color temperature of the operating light



#### Setting the operating distance of the sensor control

Defines the distance at which the non-touch switch will react to movements.

## 10.6 Sivision program

### 10.6.1 Media Player



#### Start Media Player

Media Player is started on the external PC. The keys corresponding to the Media Player PC application are displayed on the right side of the touchscreen after a file is selected:



#### Previous/next title



#### Stop playback



#### Start/interrupt playback



#### Mute



#### Adjust volume

### 10.6.2 Microsoft® PowerPoint®



#### Start PowerPoint

PowerPoint is started on the PC. The keys corresponding to the PowerPoint PC application are displayed on the right side of the touchscreen after a file is selected:



#### Previous/next slide

### 10.6.3 SI Video



#### Start SI Video

SI Video is started on the external PC if Sidexis is not installed on it. Or: SI Video is started on the internal PC if the treatment center is operated as a standalone unit. The keys for the SI Video PC application are displayed on the right side of the touchscreen:



#### Selecting the next quadrant

In single image mode, the still image in the next quadrant is displayed. In quad image mode, the next quadrant is highlighted.



#### Quad image

Display quad image or single image. Up to four single images are simultaneously displayed on the Sivision monitor in quad image mode.



#### Deleting images

All generated still images are deleted.

## 10.6.4 Sidexis

### SIDEXIS

#### Starting Sidexis

Sidexis is started on the PC. The keys for the Sidexis PC application are displayed on the right side of the touchscreen:



#### Next image

The next image window is activated.



#### Tiled layout

All open image windows are scaled to a uniform size in the display area and arranged without overlapping.



#### Cascaded layout

The opened windows are "cascaded", i.e. arranged slightly displaced behind one another. All image window titles are thus visible.



#### Overview layout

The opened image windows are scaled in the display area so that no scroll bars or as few scroll bars as possible must be displayed. The image windows are arranged without overlapping.



#### Full frame

The active image window is enlarged so that it covers the entire display area. The control elements of the Sidexis user interface are not concealed in the process.



#### Zoom in/out

This magnifies and decreases the active image window and the size of the image displayed in it on the Sivision monitor.



#### Rotate image

Rotates the image 90° counterclockwise or clockwise. With Sidexis 4, the image can be rotated 180° by pressing a key.



#### Contrast optimization filter

This image filter analyses and optimizes the current grayscale distribution of an image. In this way, for instance, details within a very low-contrast, "faint" image can be made visible.



#### Relief display filter

Image details with high contrast are displayed brighter or darker. Edges or contours within the image are thus clearly accentuated. The result is a relief-like image distortion.



#### Smooth image

To mitigate high-contrast or high-interference effects in images, the contrast between neighboring pixels is reduced or averaged. The overall definition of the image is reduced.



### Sharpen image

Contrasts between neighboring pixels are increased. This function helps to accentuate edges or contours. This gives the impression of a sharper image.



### Invert image

This function inverts the brightness values of the image pixels, thus enabling a positive or negative display of the image. The inversion can be canceled by pressing the key once again.



### Display image in pseudocolors

To enable better distinction of image details, an image can be displayed in what is called pseudo color mode. The grayscale values of the image are replaced by colors which the human eye can distinguish better from one another than the corresponding gray levels.



### Filter black dots

Single pixel errors may occur when taking digital X-rays. These pixel errors appear as individual black dots when the optimum resolution (100%) is selected. They are removed by Sidexis.



### Reducing noise

Individual scattered pixels and minor disturbing information which lead to a noisy image are eliminated without reducing the overall definition of the image.

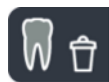

### Undo

The effect of the last filter operation is undone.



### Restore original image

The changes previously made, e.g. via filters, are canceled. The most recently saved version of the image is restored.



### Close current media window



### Close all media windows



### Cancel/confirm entry



### Accept an order

Accepts an order that was placed and is waiting in Sidexis, e.g. for creating an intraoral image with the X-ray unit of the treatment center or a video recording with the intraoral camera.



### Readiness for intraoral X-ray exposure

Establishes readiness for an X-ray exposure. A Sidexis window then opens where the image type can be selected and the image can be described in detail.

### 10.6.5 Video plugin

#### Camera

#### Start the video plugin

Sidexis 4 and the video plugin are started on the PC. The fixed keys for the video plugin are displayed on the right side of the touchscreen.



Scroll up / select previous still image



Scroll down / select next still image



Mark selected still image for import to Sidexis 4



Mark all still images for export to Sidexis 4



Import marked still images to Sidexis 4



Discard all still images



## 10.7 Setup program

### 10.7.1 User interface



#### Configuring the user interface

Opens the *User Interface* setup dialog.



#### Key tone

A setting can be made to activate or deactivate an acoustic signal that sounds when the operator touches a key on the touchscreen.



#### Calibrating the touchscreen

If the touchscreen is no longer able to precisely locate the position of a contact, it must be recalibrated.



#### Touchscreen brightness

### 10.7.2 Date and time



#### Date and time

Opens the *Date and Time* setup dialog.



#### Date



#### Time



#### 12/24 hour display

### 10.7.3 Control options



#### Configuring control options

Opens the *Control Options* setup dialog.



#### Number of user profiles

If fewer user profiles are required, their number can be limited so that only the specified users can be selected after the treatment center is switched on.



#### Cursor control

The cursor control can be set as follows:

- Field 1: Cursor control switched off
- Field 2: Cursor control switched on, without screen change
- Field 3: Cursor control switched on, with screen change



### Start dialog operating modes

The *Start dialog* can run in two operating modes. In the *Standard Start dialog* operating mode, the functions of the patient chair and instruments are each shown on separate screens. In the *EasyMode Start dialog* operating mode, the patient chair and instrument functions that are most important for the treatment are shown together on the same screen.



### Open next dialog page



### Focusing the intraoral camera using the foot control

It is possible to enable the foot control to focus the SiroCam AF / AF+ intraoral camera.

- Field 1: The display switches between a still or live image when the foot pedal is pressed. The knob on the camera can be used to focus the image.
- Field 2: The camera is focused by pressing the foot pedal. The display switches between a still or live image only when the foot pedal is pressed down fully. The knob on the camera can still be used to focus the image.
- Field 3: When the foot pedal is pressed, the camera image is focused and switched automatically from still to live image. The knob on the camera has no function.

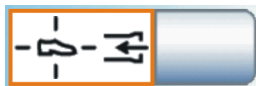

### Spray aspirator

Enables interruption and/or activation of the suction flow of the spray aspirator via the 4-way foot control on the base of the chair in any direction.



### Headrest inclination

If a motor-driven headrest is used, operation of the tilt patient couch function using the 4-way foot control can be replaced by the headrest tilt function.



### Open next dialog page



### Hash key on the assistant element

The *Hash key* on the assistant element can be assigned the X-ray viewer function or, if the X-ray viewer function is set to the white screen on the Sivation monitor, it can be assigned the white screen function.

Alternatively, the *Hash key* on the assistant element can also be used to activate the bell or hash key, e.g. if neither an X-ray viewer or a Sivation monitor is available.

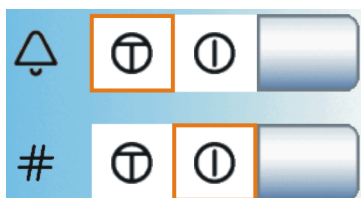

### Bell/hash (#) relay

The relay of the bell and hash (#) key can be actuated as a push button or as a switch.

- Field 1: Push button
- Field 2: Switch



#### White screen

If the treatment center has no X-ray viewer but is equipped with a Sivation monitor, the *X-ray viewer* key can change the Sivation monitor to the white screen mode.



#### Open next dialog page



#### Cleaning agent mixture for chemical suction hose cleaning

The vacuum system can be cleaned by pumping water into the receptacle of the suction hoses and extracting it from there. A cleaning agent is automatically added to the water if the dental treatment center is equipped with the chemical suction hose cleaning option. It is possible to set how much cleaning agent should be mixed with water for chemical suction hose cleaning.

#### Central supply for chemical suction hose cleaning

For clinical use, Sinus treatment centers can be equipped with a central cleaning agent supply for chemical suction hose cleaning. The function can be switched on and off.

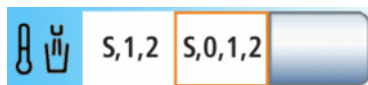

#### Tumbler heater

A setting can be made so that the tumbler heater automatically switches off when the entry/exit position (0) chair program is activated. The tumbler heater switches back on as soon as the patient chair leaves the entry/exit position.



#### Tumbler heater temperature adjustment

The temperature of the water heated by the tumbler heater can be set.

### 10.7.4

## Instruments



#### Configure instruments

Opens the *Instruments* setup dialog.



#### Quick setting keys/Function levels

Settings can be made in the *Instrument programs* using either the quick setting keys (1...100) or two freely programmable function levels (E1, E2).

When using the quick setting keys, you can choose one of two options for saving the settings you made in the instrument dialog:

- SaveMode – The *Memory* key is displayed in the instrument programs:  
The settings made in the Instrument dialog will be saved after the instrument is placed in its holder only if the Memory key was pressed and held beforehand (> 2 s).
- DropMode – *Memory* key hidden in Instrument programs:  
When the instrument is deposited, the settings made in the Instrument dialog are automatically saved.

One of the following presettings can be selected:

- Field 1: Quick setting keys with SaveMode
- Field 2: Quick setting keys with DropMode
- Field 3: Function levels



#### Afterblow

After an instrument is put in its holder, the cooling spray remaining in the instrument head or in the tip of the instrument is automatically blown out by briefly activating the chip blower.



#### External HF surgical device key

External HF surgical devices may interfere with the treatment center and Sivation monitor. Therefore, the *External HF surgical devices* key may be displayed on the *Start* sub-dialog. If the key on the sub-dialog is highlighted in orange, the treatment center is protected from interference by HF fields.



#### Open next dialog page



#### Spray temperature

The spray temperature of the instruments on the dentist element can be set.

The spray temperature of the Sprayvit M multifunctional syringe can be adjusted separately, see "Switching the instrument light on/off and setting the water temperature" [→ 102].

### 10.7.5 Network connection



#### Configure IP address setup dialog

Opens the *IP Address* setup dialog.



#### Entry of the IP Address, subnet mask and the Gateways

To configure a static network connection



#### DHCP

Activating the dynamic network configuration with DHCP (Dynamic Host Configuration Protocol)

### 10.7.6 Service domain



#### Opening the service function

The Service domain is intended to be used only by service engineers. Please contact your service technician or your dental depot.

# Index

## Numeric

- 4-way control plate, 59
- 4-way foot control, 195
- 4-way foot control plate, 61

## A

- Acoustic signals, 124
- Adapter, 243
- Additional devices, 47
- Afterblow, 199
- Air blast, short, 59, 61
- Air connection external device, 47
- Air intakes on the spray aspirator, 153
- Air vents on the spray aspirator, 153
- Amalgam separator
  - Changing the rotor, 255
  - Dispose rotor, 255
  - Message system, 258
  - Operation log, 256
- Amalgam separator operation log, 256
- Amalgam separators
  - Standards/Approvals, 21
- Anti-glare films for X-ray viewer, 170
- ApexLocator, 118
  - Acoustic signals, 124
  - Distance display, 121
  - File clamp, 119
  - in the Endodontics program, 141
  - In the Motor program, 115
  - Instrument hose, 119
  - Manual measurement with the file clamp, 125, 142
  - Motor, 119
  - Motor stop, 122, 145
  - Mucosal electrode, 119
  - Standardization, 117, 125, 141
- Approvals, 21
- Armrest, 66
- Articulating headrest, 30, 69

- Assistance element
  - Instrument positions, 43
  - Suction handpieces, 153
- Assistant element
  - Maximum load capacity, 150
  - Mini L.E.D., 156, 234
  - Overview, 42
  - Sprayvit M, 99, 229
  - Suction handpieces, 245
  - Use of blasting devices, 17
- ATS, 22
- Automatic separator, 45
- Autopurge function, 220
- AutoReverse function, 144

## B

- Backrest, 73
- Ball for instrument holder, 91, 215
- Ball stopper, 91, 215
- Bars, orange and blue, 61
- Battery change for wireless foot control, 277
- Battery disposal, 289
- Beeps, 124
- BELGAQUA, 22
- Bell key, 85, 196
- Biofilm removal, 276
- Blasting device, 17
- Boost function, 128
- Bottle holder for saline solution, 96
- Brake in support arm of dentist element, 78, 79

## C

- Cal key, 133, 140
- Calibrating the burr drive, 133
- Calibrating the motor, 133
- Calibration of the burr drive, 133
- Calibration of the burr drive
  - Calibrating the burr drive, 140
- Calibration of the touchscreen, 192

Call key, 85, 196  
Camera, 19, 174, 176, 235  
    Use with SI video, 179  
    Use with Sidexis, 181  
Canadian Standard Association (CSA), 21  
Capacitive sensor, 78, 79  
Care, cleaning, and disinfecting agents, 204  
Care, cleaning, and disinfecting intervals, 202  
CDS 60, 197  
CE marking, 21  
Chair height, 74  
Chair programs, 70, 75, 151  
Chemical suction hose cleaning, 197, 241  
Chip blower, 59, 61  
Clean key, 85  
Cleaning agent for suction hose cleaning, 242  
Coding of motor houses, 106  
Collapse position, 75, 83  
Collect amalgam residues, 247, 248, 262  
Collecting amalgam residue, 256, 259  
Composite function, 83, 151, 172  
Configuration of the treatment center, 191  
Conformity mark, 21  
Consumables, 285  
Contra-angle handpiece inertia, 133, 140  
Control options, 194  
Coolant, 93  
Counterclockwise/clockwise rotation, 144  
Couplings, 106  
Cup holder, 168, 212  
Curing lightMini L.E.D., 156  
Cursor control, 59, 60  
Cursor control , 194  
Cursor return, 61  
Cuspidor, 160, 249  
Cuspidor flushing, 84, 151, 161  
Customer Service Center, 10  
CW/CC rotation, 113  
CW/CCW rotation, 134, 140

## D

Data transfer, 51  
Date and time, 193  
Declaration of conformity, 21  
Default settings, 191  
Dental unit plugins  
    ApexLocator distance display, 123  
    Time synchronization , 193  
    Video plugin, 189  
Dentist element  
    Covering with surgical drape, 138  
    Fixed keys, 81  
    Handles, 209  
    Height adjustment, 77  
    Instrument holder, 90, 214  
    Instrument positions, 37  
    Move, 78  
    Overview, 32  
    Sprayvit M, 99  
    Standby switch, 50  
Dentist element with swivel arm  
    Instrument holder, 90  
Deutscher Verein für Gas und Wasser (DVGW) =  
    German Gas and Water Association, 21  
DHCP, 201  
Dialogs  
    Instrument dialog, 90  
Direct starter, 93  
Disinfectant for the water lines, 251  
Disinfectant residues, 207  
Disinfection system, 45, 162, 251  
Disposal of old electrical and electronic devices, 288  
Distance display, 121  
Distance display in Sidexis 4, 123  
Double articulating headrest, 30, 69  
Drape, 138  
Drinking water supply, 162  
Driving air proportional valve, 104  
DropMode and SaveMode, 88

## E

E1, E2, 86, 199  
EasyMode Start program, 54  
EasyTouch user interface, 18, 39, 192  
EasyTouch user interface , 52, 208  
Electric motor, 106  
Electromagnetic compatibility, 18, 19  
Electronic torque limitation, 133, 134, 143  
Electrosurgery, external unit, 200  
Endodontic management, 147  
Endodontics, 115  
Endodontics (treatment), 130  
Endodontics with SiroSonic TL, 129  
enretec GmbH, 288  
Entry/exit position 0, 59, 151  
Entry/exit position 0 , 70  
Error message, 57  
External device connection, 47  
External HF surgical device, 19  
External HF surgical unit, 200  
External PC, 184  
Extract remaining water, 261

## F

Favorite keys, 199  
FCC, 22  
File clamp, 119  
File selection, 139  
Filter  
    Air and water, 254  
    Gold trap, 248  
    Suction hoses, 246  
    Wet suction, 261

Firmware, 11, 191

Fixed key

    Bell, 196  
    Chair programs, 151  
    Clean, 85  
    Composite function, 83, 151, 172  
    Flushing cuspidor, 84, 151  
    Freely selectable function, 85

Hash, 196

Hash key/bell/X-ray viewer, 152

Operating light, 151, 171, 172

Setup, 85, 191

Shock positioning, 83

Standby switch, 50, 81

Timer function, 82

Tumbler filling, 84, 151

Fixed key

    Shock positioning, 75

Flat screen monitor, 175

Flushing cuspidor, 151

Focusing the intraoral camera, 178, 195

Foot control

    Battery (wireless foot control), 58, 277

    Chip blower, 59

    Cleaning, 216

    Cursor control, 59, 60, 194

    Direct starter/speed foot control, 93

    Electromagnetic compatibility, 19

    login (wireless foot control), 58

    Operating , 58

    Overview, 31

    Spray/NaCl, 59

    Standards/approvals, 22

    Wireless interface (wireless foot control), 24

Footer, 56, 57

Function levels, 86, 199

## G

Gold trap, 248

Guide roller on the Sinius CS dentist element, 90

Guide rollers, 90

## H

Handles on dentist element, 78, 79

Handles on the dentist element, 209

Hands-free operation, 60

Hash key, 85, 152, 196

- Head rest
    - Disinfecting, 213
  - Headrest
    - Double articulating headrest, 30, 69
    - Motor-driven headrest, 29, 196
    - Motorized headrest, 67
  - Height adjustment
    - Dentist element, 77
  - Heliodent Plus, 173
  - Heliodent Plus X-ray tube unit, 173
  - HF surgical device, external, 19
  - HF surgical unit, external, 200
  - High-speed handpiece, 104
  - High-speed handpiece hose, 239
  - Hose coding, 106
- I**
- IEC socket, 47
  - Immunosuppressed patients, 15
  - Implant work steps, 135
  - Implantology, 130
  - Industry Canada, 22
  - Initial startup, 49
  - Inspection and maintenance, 280
  - Instrument
    - Light, 93
  - Instrument holder, 90
    - Assistant element, 216
    - Dentist element, 214
    - Tray, 165, 166, 167, 211
  - Instrument hose, 119, 239
  - Instrument hose sleeve, 138
  - Instrument light, 93, 102, 104
  - Instrument program, 86
  - Instruments
    - Afterblow, 199
    - Automatic purging (autopurge function), 220
    - Ball stopper, 91
    - Care and cleaning, 226
    - CCW/CW rotation, 59
    - Configuring, 199
    - Coolant, 93
    - CW/CC rotation, 113
    - CW/CCW rotation, 140
    - Drive motors, 17
    - High-speed handpiece, 104
    - Holder/positions on assistant element, 43
    - Holder/positions on dentist element, 37
    - Intensity, 126
    - Light, 102, 104
    - Mini L.E.D., 156, 234
    - Motor and coupling versions, 106
    - Motor holder, 138
    - Save settings, 88
    - Saving settings, 137
    - SiroNiTi, 115
    - SiroSonic TL, 126
    - Speed, 111, 133, 143
    - Spray amount, 94
    - Sprayvit M, 99, 229
    - Switch on/control, 59
    - Torque limitation, 115, 133, 134, 143
    - Treatment function, 130
  - Instruments , 217
  - Intended use, 12
  - Intensity, 126
  - Intensity increase (Boost function), 128
  - Intermittent operation, 17
  - Internal PC, 184
  - Intervals for care, cleaning, and disinfecting, 202
  - Intraoral camera, 19, 174, 176, 235
    - Use with SI video, 179
    - Use with Sidexis, 181
  - IP address, 201
- K**
- Key color, 52
  - Key tone, 192
  - Keys, missing, 52, 191



## L

- Last Position Memory function, 71
- LEDview Plus, 171
- Live image, 179, 181
- Load capacity
  - Assistant element, 150
  - Cup holder, 168
  - Dentist element, 77
  - Patient chair, 17
  - Tray, 165, 166, 167
- Locking brake in support arm of dentist element, 78, 79
- Lumbar support function, 76

## M

- Main switch, 49, 50
- Maintenance Certificate, 280
- Maintenance deadline, 280
- Maintenance Manual, 280, 281
- Maintenance Service , 12
- Manual measurement with the file clamp, 125, 142
- Manufacturer's address, 10
- Maximum load capacity, 77
  - Assistant element, 150
  - Dentist element, 77
  - Patient chair, 17
  - Tray, 165, 166, 167
- Mechanical torque limitation, 115
- Media player, 186
- Media quality, 15
- Medical Product Log, 281
- Memory key, 88, 137, 199
- Message system of the amalgam separator, 258
- MET Labs, 21
- Metal oxide blasting device, 17
- Microbiological test, 204
- Mini L.E.D., 156, 234
- Minimum PC requirements, 24
- Monitor, 175
- Motor holder, 138
- Motor stop (ApexLocator), 145

- Motor versions, 106
- Motor-driven headrest, 196
- Mouth rinsing position S, 59, 71, 151
- Mucosal electrode, 119
- Multifunction syringe Sprayvit M, 99
- Multi-functional syringe Sprayvit M, 229
- Municipal water, 162

## N

- NaCl, 59, 134
- NaCl flow rate, 98, 134
- NaCl pump, 96
- NaCl rinsing, 136
- Network configuration, 201

## O

- Operating conditions, 24
- Operating light, 151, 171
- Operating voltage of instrument light, 105
- Original parts, 18
- OTP dentist element, 79
  - Positioning, 79

## P

- Panoramic X-ray viewer, 169
- Patient chair, 73
  - Chair programs, 70, 75
  - Drive motors, 17
  - External device connection, 47
  - Lumbar support function, 76
  - Manual movement, 73
  - Maximum load capacity, 17
  - Overview, 28
  - Power switch, 49
  - Safety switch, 64
  - Shock positioning, 75
  - Start program operating modes, 53
  - Stop movement, 65
- PC, 19, 184
- PC control, 184
- Peristaltic pump, 96
- Power consumption, 23, 50

- Power switch, 49
- PowerPoint, 186
- Program change, 56, 60, 62
- Programs
  - Instrument program, 86
  - Settings screen, 56
  - Sivision program, 185
  - Start program, 53
  - Sub-screen, 56
- Prolonged treatment, 241
- Proportional valve, 104
- Protection class, 23
- Purge function, 217
  
- Q**
- Quick setting keys, 86, 199
  
- R**
- Reciprocating rotating files, 141
- Remote access, 284
- Remote diagnosis, 284
- RoHS Directive, 21
- rotation Instruments
  - CW/CCW, 134
  
- S**
- Safety checks, 280
- Safety instructions, 14
- Safety switch, 64
- Saliva ejector, 153, 245
- Salt blasting device, 17
- Sanitization of the water lines, 49
- Sanitizing the water lines, 264
- SaveMode and DropMode, 88
- Screens, 39
- Sediment container, 259
- Select endo file, 139
- Self-sufficient water supply, 162
- Settings screen, 56
- Setup key, 85, 103, 191
- Shock positioning, 75, 83
- SI video, 179
- Sidexis, 181, 187
- Sidexis 4 plugins, 123, 189, 193
- SiroCam, 174, 235
- SiroNiTi, 115
- SiroSonic TL, 126
- SiroSonic TL scaler, 126
- Siucom Plus, 174, 184, 185
- Sivision Connect, 174, 184, 185
- Sivision Digital, 19, 174, 235
- Sivision Digital video system, 19, 174, 235
- Sivision monitor, 175
- Sivision program, 185
- Sliding track, 78
- Socket on external device connection, 47
- Software version, 11, 191
- Spare parts, 285
- Speed, 111, 133, 143
- Speed foot control, 93
- Spray, 59
- Spray amount, 94
- Spray aspirator, 153, 195, 245
- Spray tempering, 200
- Sprayvit M, 99, 229
- Standardization of the ApexLocator, 117, 120, 125, 141
- Standards, 18, 21
- Standby mode, 49
- Standby switch, 50
- Start program, 53
- Status line, 57
- Sterile operation, 138
- Sterile work, 60
- Still image, 179, 181
- Stop movement, 65
- Storage conditions, 24
- Sub-screen, 56
- Suction handpieces, 153, 245
- Suction hose adapter for the cuspidor, 243
- Suction hoses, 241, 246

Suction system, 243  
    Blasting device, 17  
    Cleaning, 241  
    Cleaning agent additive, 197  
    Disinfection, 246  
    Filter, 246  
Support arm, 165, 166, 167, 211  
Surfaces, 207  
Surgical drape, 138  
Surgical light, 171  
Surgical procedures, 138  
Surgical suction, 153, 154, 245  
Swivel arm dentist element, 78  
    Instrument holder, 215  
    Positioning, 78

**T**

Technical data, 23  
Tempering  
    Spray, 200  
    Sprayvit M, 103  
    Tumbler filling, 84  
Time and date, 193  
Time synchronization with the PC, 193  
Timer function, 82  
Torque acoustic signal, 137, 145  
Torque limitation, 115, 133, 134, 143  
Total Count Tester, 204  
Touchscreen, 18, 39, 52, 192, 208  
Transfer user data, 51  
Transport conditions, 24  
Tray, 165, 166, 167, 211  
Treatment function, 130  
Treatment light, 171  
Tumbler filler, 84, 151  
Tumbler filling with automatic sensor control, 160  
Tumbler heater, 197, 198

## U

Ultrasonic handpiece, 126  
Upholstery, 213

USB interface, 190  
Use saline solution, 96  
User profile, 51, 194

## V

Ventilation slots, 17  
Video plugin, 189

## W

Warning triangle, 282  
Warranty, 280  
Water and air connection, 47  
Water connection external device, 47  
Water quality, 15  
Water Tempering, 84  
Water tempering Sprayvit M, 103  
Water unit  
    Amalgam separator, 255, 258  
    Cuspidor, 160  
    Cuspidor flushing , 161  
    Flushing cuspidor, 84, 151  
    Overview, 45  
    Sediment container, 259  
    Self-sufficient water supply, 162  
    Suction hose cleaning, 241, 243  
    Tumbler filler, 84, 151  
    Tumbler filling with automatic sensor control, 160  
    Wet suction, 261  
Water, microbiological test, 204  
Wet suction, 261  
White balance for intraoral camera, 183  
White screen on Sivision monitor, 152  
White screen on the Sivision monitor, 196  
Wireless phones, 18  
Work steps for implantology, 135

**X**

X-ray viewer, 152, 169, 196

---

We reserve the right to make any alterations which may be required due to technical improvements.

© Sirona Dental Systems GmbH  
D3561.201.01.18.02 01.2022

Sprache: englisch  
Ä.-Nr.: 130774

Printed in Germany

---

**Sirona Dental Systems GmbH**



Fabrikstr. 31  
64625 Bensheim  
Germany  
[www.dentsplysirona.com](http://www.dentsplysirona.com)

Order No **6322726 D3561**