

User Manual

MELAtherm[®] 10 Evolution

Washer-Disinfector

from software version 3.0.20



EN

CE 0197

Dear customer,

We thank you for your confidence demonstrated by the purchase of this MELAG product. As an owner-run and operated family concern founded in 1951, we have a long history of successful specialization in hygiene products for practice-based use. Our focus on innovation, quality and the highest standards of operational reliability has established MELAG as the world's leading manufacturer in the instrument reprocessing and hygiene field.

You, our customer are justified in your demand for the best products, quality and reliability. Providing **“competence in hygiene”** and **“Quality – made in Germany”**, we guarantee that these demands will be met. Our certified quality management system is subject to close monitoring: one instrument to this end is our annual multi-day audit conducted in accordance with EN ISO 13485. This guarantees that all MELAG products are manufactured and tested in accordance with strict quality criteria.

The MELAG management and team.

Contents

1 General guidelines	5
Symbols used	5
Formatting rules	5
Disposal	5
2 Safety	6
3 Performance specifications	8
Intended use	8
User benefits	8
Program sequence	9
Process agents	10
4 Description of the device	11
Scope of delivery	11
Views of the device	11
Symbols on the device	13
Operating panel and acoustic signal	15
Menu structure	18
Water softening unit	19
5 First steps	20
Setup and installation	20
Water supply	20
Switching the device on and off	21
Video tutorials	21
MELAconnect App	22
Opening and closing the door	22
Manual door emergency-opening	22
Inserting the basis basket	23
Filling the regenerating salt	23
Regenerating the water softening unit	25
Metering process agents	25
Holding process agents ready	26
Removing air from the metering system	28
6 Cleaning and disinfection	29
Type of load	29
Wet/dry storage	29
Preparation and pre-cleaning	29
Arranging the load	30
Reprocessing hollow-body instruments	30
Reprocessing dental transmission instruments	31
Reprocessing ophthalmological instruments	31
Overview of programs	33
Selecting, starting and monitoring the program	34
Manual program abort	35
Authentication and batch approval	36



Removing the load after program end.....	40
7 Logging	41
Batch documentation	41
Output media.....	41
Outputting logs immediately and automatically.....	42
Subsequent log output	43
Deleting the saved logs.....	44
Determining the format for the program logs	44
Finding the logs.....	47
8 Settings	48
Settings menu	48
Log settings.....	49
Setting the date and time	54
Setting the display brightness	55
Setting the idle mode	55
Setting the volume of the signal tone.....	56
Setting the volume of the key tone.....	56
Connectivity.....	57
Setting the language	57
Setting the water supply.....	58
Setting the water hardness	58
Administrative settings	59
9 Function tests	64
Automatic and manual functional check.....	64
Measuring conductivity.....	64
10 Maintenance.....	65
Maintenance intervals	65
Regular checks and cleaning	65
Cleaning on demand	67
Avoiding staining	68
Replacing the filter in the drying fan.....	68
Maintenance.....	69
(Process) Validation	69
11 Pause times	70
Decommissioning.....	70
Transport within the practice	71
12 Malfunctions	72
Displaying events in MELAconnect.....	73
Notifications, warning and malfunction messages	73
13 Technical data	87
14 Accessories and spare parts	89
15 Documentation and approval.....	90
Glossary	91

1 General guidelines



Please read this user manual carefully before commissioning the device. The manual includes important safety instructions. Make sure that you always have access to digital or printed version of the user manual.

Should the manual no longer be legible, is damaged or has been lost, you can download a new copy from MELAG download centre at www.melag.com.

Symbols used

Symbol	Explanation
	Indicates a dangerous situation, which if not avoided, could entail slight to life-threatening injuries.
	Draws your attention to a situation, which if not avoided, could result in damage to the instruments, the practice fittings or the device.
	Draws your attention to important information.

Formatting rules

Example	Explanation
see Chapter 2	Reference to another text section within this document.
Universal- Program	Words or phrases appearing on the display of the device are marked as display text.
	Prerequisites for the following handling instruction.
	Refer to the glossary or another text section.
	Information for safe handling.

Disposal

MELAG devices are synonymous with high quality and a long life-span. When you eventually need to decommission your MELAG device, the required disposal of the device can take place with MELAG in Berlin.

Dispose of accessories and consumption media which you no longer require in the appropriate manner. Comply with all relevant disposal specification in terms of possibly contaminated waste.

The packaging protects the device against transport damage. The packaging materials have been selected for their environmentally-friendly disposability and can be recycled. Returning the packaging to the material flow reduces the amount of waste and saves raw materials.

Dispose of waste from process agents in accordance with the specifications from the manufacturer of the process agents. Information regarding this topic is provided in the safety data sheets or can be obtained directly from the manufacturer of the process agents.

MELAG draws the operator's attention to the fact that they are responsible for deleting personal data on the device to be disposed of.

MELAG draws the operator's attention to the fact that they may be legally obliged (e.g. in Germany according to ElektroG) to remove used batteries and accumulators non-destructively before handing over the device, provided they are not enclosed in the device.

2 Safety



When operating the device, comply with the following safety instructions as well as those contained in subsequent chapters. Use the device only for the purpose specified in these instructions. Failure to comply with the safety instructions can result in injury and/or damage to the device.

Qualified personnel

- The instrument reprocessing using this washer-disinfector may only be carried out by [▶competent personnel](#).
- The operator must ensure that the users have been trained in the operation and safe handling of the device.
- The operator must ensure that the users are regularly trained in the operation and safe handling of the device.

Setup, installation and commissioning

- Check the device after unpacking for any damage suffered during transport.
- The device should only be setup, installed and commissioned by MELAG authorised persons.
- The connections for electrical provision and water supply and discharge must be setup by trained personnel.
- The disconnection device must be freely accessible after installation so that the device can be taken from the electricity supply at any time.
- DTA device versions are disconnected from the mains via the on-site main switch. DTB device versions disconnect from the mains by pulling the mains plug from the socket.
- Using the optional electronic leak detector (water stop) minimises the risk of water damage.
- The device is not suitable for operation in explosive atmospheres.
- Install and operate the device in a frost-free environment.
- The device is conceived for use outside the patient area. The device should be located a minimum of 1.5 m radius away from the treatment area.
- The documentation media (computer, CF card reader etc.) must be placed in such a way that they cannot come into contact with liquids.
- Observe all the information contained in the technical manual during commissioning.

Power cable and power plug

- Comply with all legal requirements and locally-specified connection conditions.
- Never operate the device if the plug or power cable are damaged.
- The power cable or plug should only be replaced by [▶authorised technicians](#).
- Never damage or alter the power plug or cable.
- Never unplug by pulling on the power cable. Always take a grip on the plug.
- Ensure that the power cable does not become jammed in.
- Never lead the cable along a source of heat.
- Never fix the power cable with sharp objects.

Daily operation

- Only reprocess instruments designed by their manufacturer for automatic [▶reprocessing](#) in a washer-disinfector. Comply with the instructions issued by the instrument manufacturer in accordance with [▶EN ISO 17664](#). It is especially important to comply with the specifications from the instrument manufacturer regarding cleaning instruments for the first time after purchasing new instruments.
- Use only original MELAG accessories or those from other suppliers authorised for use by MELAG.
- When using non-MELAG accessories for the mounting of instruments (especially hollow-body instruments) comply with the information from the manufacturer of the accessories.
- Comply with the specifications of the national standards and directives pertaining to the reprocessing of instruments, the instrument manufacturer's reprocessing instructions and those from the [▶AKI](#).

- The fore ventilation slots may not be covered.
- Never operate the device unattended (e.g. overnight). Unsupervised operation of the device can result in damage to the device or your facility and is performed at your own risk. In such a case, MELAG does not accept any liability.

Process agents

- Handle all ▶[process agents](#) with care. The cleaning agents, neutralisers and rinse aids contain irritants and even caustic substances.
- Comply with the safety instructions in the documentation of the process agents and wear the prescribed protective equipment.
- In the case of damage, every type of liquids (e.g. in the drawer, in the device floor trough or liquid issued from the device) could potentially contain aggressive process agents.

Storage and transport

- Avoid frost or extreme heat during the transport and storage. If this cannot be ensured, unpack the device and store it at room temperature for at least two hours before installation and commissioning.
- Avoid strong shocks/vibrations.

Maintenance

- Maintenance should only be performed by ▶[authorised technicians](#).
- Maintain the specified servicing intervals.

Repair

- Never open the device housing. Incorrect opening and repair can compromise electrical safety and pose a danger to the user. The device may only be opened by an ▶[authorised technician](#) who must be a ▶[qualified electrician](#).

Malfunctions

- Should the device issue the same malfunction message repeatedly, turn off the device and if necessary, inform your stockist.
- The device may only be serviced by ▶[authorised technicians](#).

Notification requirement in the event of serious accidents in the European Economic Area

- Please note that all serious accidents which occur in connection with the medical product (e.g. death or serious deterioration in the state of health of a patient) which were presumably caused by the product, must be reported to the manufacturer (MELAG) and the relevant authority of the member state, in which the user and/or patient resides.

3 Performance specifications

Intended use

The MELAtherm 10 Evolution DTA/MELAtherm 10 Evolution DTB is intended for use in a medical context such as a clinic or medical and dental practices. ▶EN ISO 15883-1 and -2 defines it as a washer-disinfector intended for ▶reprocessing medical instruments prior to their re-use or a further reprocessing step such as sterilization in a steam sterilizer. You can subject thermostable medical instruments (i.e. instruments which are heat resistant to a temperature of 95 °C) and invasive thermostable instruments to automatic reprocessing as long as they are suitable for this purpose and have been approved for such treatment by their manufacturer. The cleaning is performed using water in combination with a ▶process agent (e.g. MEtherm). Subsequent disinfection is thermal disinfection. This device is not intended to be used in a patient environment.

This device is NOT suitable for the reprocessing of:

- Thermo-unstable instruments e.g. flexible endoscopes
- Laboratory waste requiring disposal
- Crockery
- Bedpans

User benefits

Universal use

The device both cleans and disinfects. The disinfection phase is conceived so as to reach an ▶A0 value of at least 3000. This kills vegetative bacteria, fungi and their spores and viruses (incl. HBV, HCV). This means that the ▶effectiveness range AB is reached in accordance with the specifications of the Robert Koch Institute.

Active drying

The device is equipped with active drying. An integrated drying fan dries the instruments from outside and in after cleaning and disinfection. The HEPA filter guarantees drying with contamination and particle-free air. This protects the instruments against corrosion. Manual subsequent drying is usually not necessary. The geometry of some hollow-body instruments mean that they require additional drying.

Automatic sieve recognition

The device recognises automatically before a program start whether the fine sieve has been inserted in the base of the washing chamber. The fine sieve avoids a situation in which instrument components enter the opening of the drain pump or the circulating pump during cleaning, thereby compromising the function of the pumps, rinse arms and the injector rail.

Internal water softening

The device is equipped with an internal water softening unit. The water hardness of the local drinking water is set on the device. The internal water softening unit then automatically adjusts itself to the most suitable performance. This ensures best reprocessing results.

Monitoring the rotation speed of the rinse arms

The rotation speed of the rinse arms is subject to permanent monitoring during a program run. This ensures that the cleaning process proceeds without hindrance and the rinse arms do not become blocked e. g. by protruding instruments in the washing chamber.

Monitoring the rinsing pressure

The rinse pressure is monitored by a pressure sensor during a program run. This ensures an effective cleaning performance. The device aborts a current program if too much foam is generated.

Metering monitoring

The required amounts of cleaning agent and neutraliser are metered using a metering pump. A measuring turbine performs flow monitoring. The rinse aid is metered using a metering pump subject to monitoring for rotation speed.

Drawer for process agents

The drawer for the ▶**process agents** is located in the lower area of the device in which the cleaning agent, neutraliser and rinse aid containers are stored.

Automatic conductivity measurement

If the device is supplied with ▶**DI water** in the final rinse, the DI water fed in is subject to automatic internal conductivity measurement.

Program sequence

The following program steps are indicated on the display during the program run. The program runs will be significantly defined through the process-relevant parameters (VRP) specified in the technical manual.

Pre-cleaning

The water-soluble soiling will be rinsed roughly with cold water and removed from the device. This prevents protein fixing from too high a water temperature; the soiling load of the rinse liquor in the following program steps will be reduced considerably. In Intensive-Program, this step is performed twice.

Cleaning

Water is fed into the washing chamber and heated. When the metering temperature has been reached, a mildly-alkaline or alkaline ▶**cleaning agent** will be metered. Once the cleaning temperature has been reached, the holding time begins, which ensures a reproducible cleaning effectiveness.

Neutralisation

The cleaned instruments will be freed from alkali residue during neutralisation. At the same time, this prevents the development of acid-soluble deposits such as limescale and foreign corrosion. To this end, water will be fed into the washing chamber, a citric acid or phosphoric acid-based ▶**neutraliser** will be metered and short circulation will be performed.

Intermediate rinsing

Water is fed into the washing chamber and circulated cold. This rinses off the neutraliser residue. In Ophthalmo-Program, this step is performed twice.

Disinfection

The disinfection is the same as the final rinse. The cleaned and rinsed instruments are subject to thermal disinfection. Water, preferably ▶**DI water** is fed into the washing chamber and heated. When the metering temperature is reached, a ▶**rinse aid** is metered in the Quick-Program, Universal-Program and Intensive-Program. Once the disinfection temperature has been reached, the holding time begins, which ensures a reproducible disinfectant effect.

Drying

Active drying is effected by drawing ambient air through a class H13 ▶**HEPA filter** and heating it. The instruments are dried inside and out with hot, filtered air.

Displaying the batch counter

The display shows the batch number of the last program run and the total batch counter after every program end or the end of a program abort.

Process agents

Note the following:

- Use only suitable ▶**process agents**. The use of unsuitable process agents can impair the reprocessing result and material compatibility.
- MELAG recommends using MEtherm process agents. The suitability of the MEtherm process agents for use in MELAtherm has been proven in comprehensive cleaning effectiveness and material-compatibility tests.
- Other process agents must not be used if their performance and safety for use with the MELAtherm have not been conformed by the manufacturer of the process agents.
- Please address all queries relating to the compatibility of process agents with the instruments to the instrument manufacturer.
- Every change of a process agent in a validated device necessitates revalidation. Comply with all national regulations.

Pre-set metering concentration

The pre-set metering concentrations have been harmonised to MEtherm.

Program	▶Cleaning agent	▶Neutraliser	▶Rinse aid
Universal-Program	6 ml/l	1.5 ml/l	0.3 ml/l
Quick-Program	6 ml/l	1.5 ml/l	0.3 ml/l
Intensive-Program	10 ml/l	1.5 ml/l	0.3 ml/l
Ophthalmic-Program	6 ml/l	1.5 ml/l	-----



NOTICE

When using process agents from other manufacturers, it may be necessary to adjust the metering concentration. Only trained and authorised service technicians are permitted to change the metering concentration.

4 Description of the device

Scope of delivery

Please check the scope of delivery before setting up and connecting the device.

Standard scope of delivery

- MELAtherm 10 Evolution Washer-Disinfector
- User manual
- Technical manual
- Record of installation and setup
- Manufacturer's inspection report and declaration of conformity
- Warranty certificate
- User manual Accessories for MELAtherm
- MELAflash CF card for documentation purposes
- Filling funnel for the regenerating salt
- Starter package of regenerating salt
- Hose bend for outflow
- Ø 16-27/9 clamp for outlet hose
- Process agent labels
- Magnet pocket for device log book

Views of the device

View from front

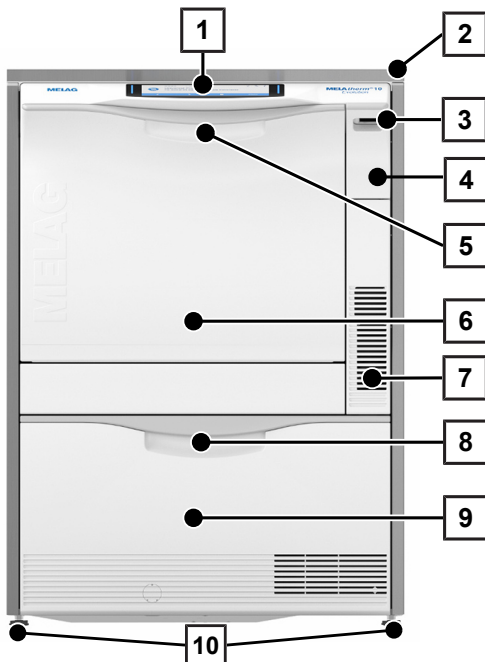

- 1 Operating and display panel
- 2 Cover plate (optional)
- 3 Power switch
- 4 Cover for card slot and Ethernet data interface (for service)
- 5 Door handle
- 6 Hinged door, opens forwards
- 7 Ventilation slots for air outlet
- 8 Drawer handle
- 9 Drawer for [process agents](#)
- 10 Device foot

Cover card slot open

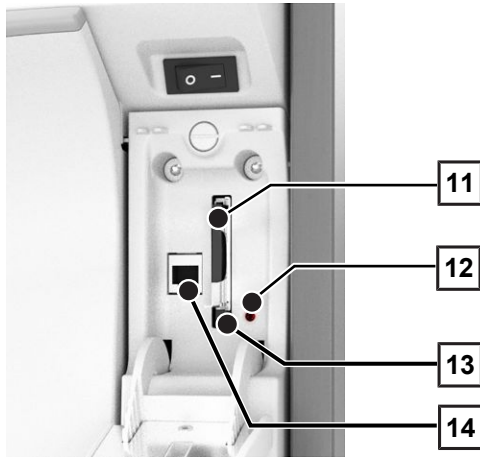

- 11 Card slot
- 12 LED
- 13 Ejection button
- 14 Ethernet data connection

View from rear

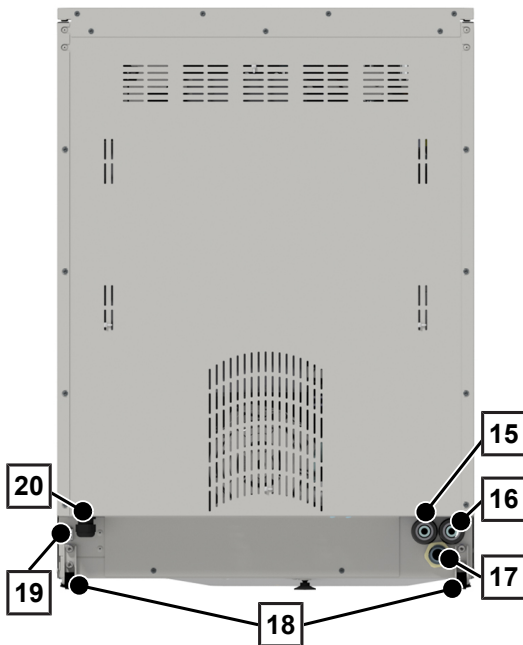

- 15 Connection for de-ionised water ([▶DI water](#))
- 16 Connection for cold water
- 17 Effluent connection
- 18 Transport rollers
- 19 Ethernet data connection for permanent network connection
- 20 Mains cable

View from inside

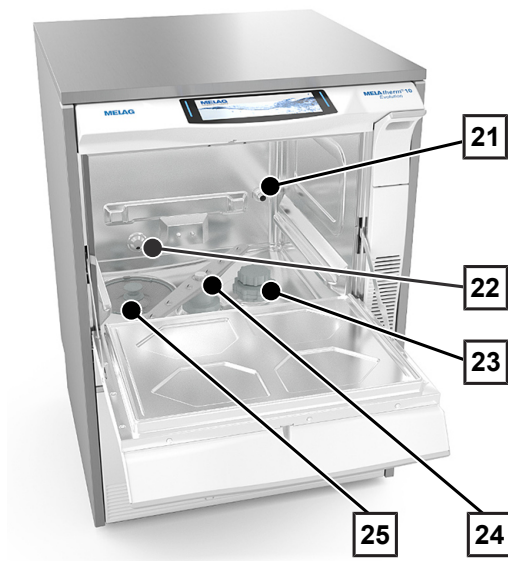

- 21 Connection tube for injector rails
- 22 Cold water (CW) inflow and de-ionised water (DI)
- 23 Salt container
- 24 Lower rinse arm
- 25 Coarse and fine sieve

Process agent drawer, open

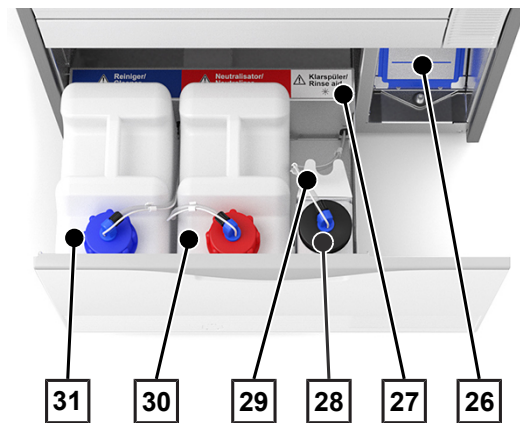

- 26 Drying fan pre-filter
- 27 Assignment of the process agents
- 28 Container for rinse aid with suction lance
- 29 Suction lance bracket
- 30 Container for neutraliser with suction lance
- 31 Container for cleaning agent with suction lance

Symbols on the device



Manufacturer of the medical device



Date of manufacture of the medical device



Identifies a medical device



Medical device serial number from the manufacturer



Article number of the medical device



Indicates the permitted temperature range (min./max.) of the water supply.



Flow pressure on the water inflow connected from min. to max.



Electrical connection of the device: AC current



Internal device fuse, rated in amperes [A]



The user manual includes important safety information. Failure to comply with these instructions can result in injury and material damage.



Read this user manual carefully before commissioning the device.



In affixing this CE mark, the manufacturer declares that this medical product fulfils the basic requirements of the Medical Device Directive. The four-digit number confirms that this is monitored by an approved certification agency.



The device may not be disposed as domestic waste. The vendor is responsible for appropriate disposal of the device - it must be delivered to the vendor to be disposed of.



The WaterMark certificate is a seal of quality for plumbing and drainage products in Australia and New Zealand.

It confirms that a product meets the requirements of the ABCB (Australian Building Codes Board) and is approved for application.

Symbols on the power switch



Switching on device



Switching off device

Operating panel and acoustic signal

Colour touch display

The operating panel consists of a 7.8-inch touch display.

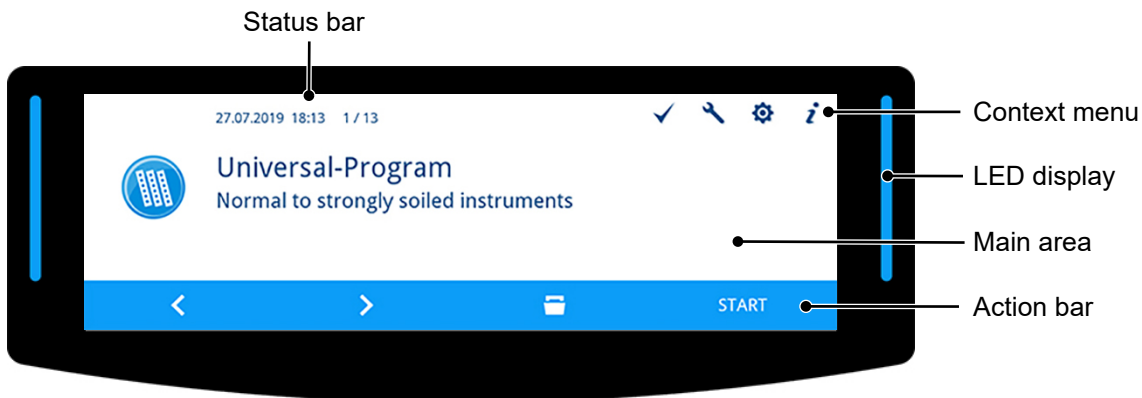

Status bar

The status bar is located at the top edge of the display.







The date and time are permanently displayed.

To the right of the time, the navigation path and page numbers (e.g. 1 / 13 = page 1 of 13) are displayed if there are several pages in a menu.

In the event of warning and malfunction messages, the serial number of the device and the ID of the event are displayed. This is the information that can be transmitted via QR code to MELAconnect or manually to the troubleshooting section of the MELAG website to access context-sensitive troubleshooting help.

Context menu

The context menu displays the submenus, modes and function buttons temporarily and in a context-dependent fashion.

Button	Name	Description
	VALIDATION MODE	The button is displayed when the respective program can be executed in validation mode. Press the button to switch to validation mode. Validation mode can only be performed by the person performing the validation with an appropriate PIN.
	MAINTENANCE MODE	The button is displayed when the respective program can be executed in maintenance mode. Press the button to switch to maintenance mode. Maintenance mode can only be performed by the service technician with an appropriate PIN.
	SETTINGS	Press the button to switch to the Settings menu.
	STATUS	Press the button to switch to the Status menu. Device information and device status regarding switching and sensor states are displayed.
	LICENCE	The button is displayed in the Status 1 / 14 menu view. Press the button to call up the licence information for the device.
	DELETE	The button is displayed in the Log output > All logs menu. Press the button to delete all logs in the internal log memory.
	QR-CODE	The button is displayed in the event of a malfunction. Press the button to open the additional menu for warning and malfunction messages.

LED display and acoustic signals

The LED display to the left and right of the main area indicates operating states by colour.

An acoustic signal is linked to the colour of the LED display and indicates an expected event.

Colour of the LED	Description
Blue	<ul style="list-style-type: none"> ▪ Standby ▪ Readiness after starting the device ▪ User action ▪ Program active/video tutorial running
Green	<ul style="list-style-type: none"> ▪ Program successful ▪ Active drying can be terminated prematurely ▪ Measurement successful
Yellow	<ul style="list-style-type: none"> ▪ Notification (e.g. fill salt storage, start the Regeneration program) ▪ Warning message ▪ Software update active
Red	<ul style="list-style-type: none"> ▪ Malfunction message ▪ Program/measurement not successful due to system abort ▪ Program/measurement not successful due to user abort



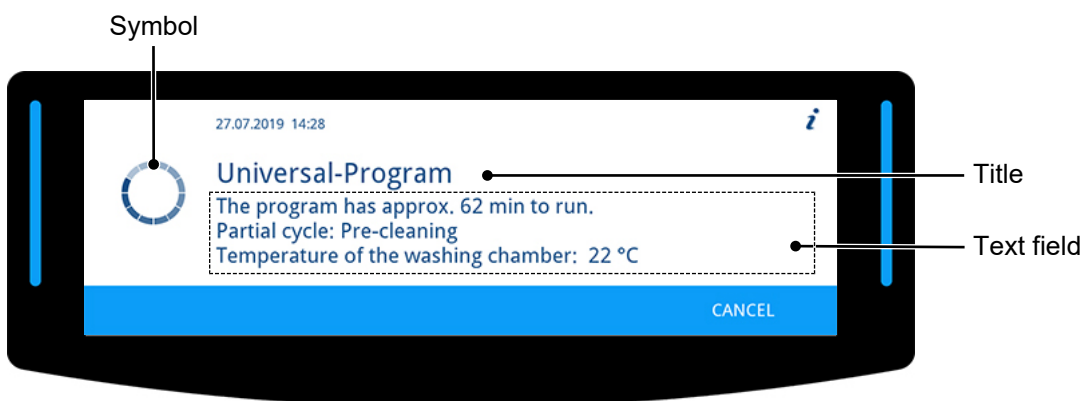

Main area

On the left-hand side of the main area, a symbol is displayed to indicate programs, additional programs, logs, program results, messages, menus or PIN-protected areas.









On the right-hand side is the title bar showing menu items, values, statuses of settings or headings of dialogues. The text field is below the title bar.



Symbol	Name	Description
	Busy indicator	Independent activities such as a program run, log output or software updates are visualised via animated busy indicator in a clockwise fashion.
	successful	Symbols designating the program result currently displayed
	not successful	

Symbol	Name	Description
	Notification	Symbols to indicate the currently displayed message about an event or the device status
	Warning	
	Malfunction	
	Documentation	Additional markings that indicate the availability of assistance (e.g. in the user manual, in MELAconnect or on the troubleshooting area in the MELAG website) regarding the issue with which the current message is concerned
	QR code	

Action bar

Button	Name	Description
	BACK	Press the button to display the previous view or select a lower parameter.
	FORWARDS	Press the button to display the next view or to select a higher parameter.
	LEAVE	Press the button to switch to the higher-level menu.
	CONFIRM	Press the button to confirm the selection or entry.
	EDIT	Press the button to change the displayed parameter.
	UNLOCK	Press the button to unlock the door.
	DETAILS	Press the button to get more information.
	SKIP	Press the button to skip steps.

Menu structure

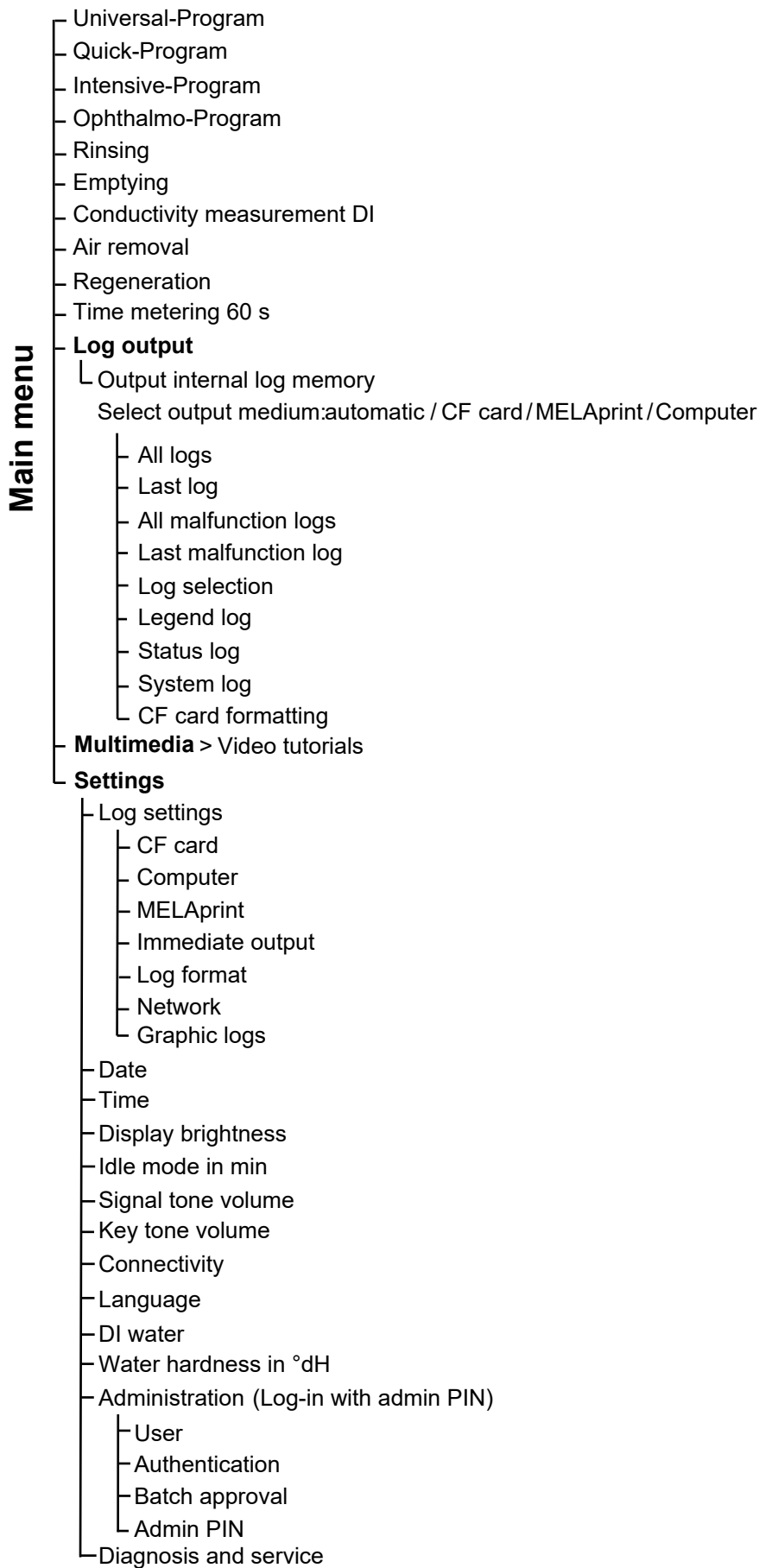

Water softening unit

The tap water is processed in the internal water softening unit to produce an optimal cleaning outcome.

- ▶ Use coarse-grain regeneration salt (NaCl) to regenerate the water softening unit.

Water hardness conversion table

°dH	mmol/l	°f	°e	°dH	mmol/l	°f	°e	°dH	mmol/l	°f	°e
1	0.2	2	2	15	2.7	27	19	28	5.0	50	36
2	0.4	4	3	16	2.9	29	20	29	5.2	52	37
3	0.5	5	4	17	3.1	31	22	30	5.4	54	38
4	0.7	7	5	18	3.2	32	23	31	5.6	56	39
5	0.9	9	7	19	3.4	34	24	32	5.8	58	41
6	1.1	11	8	20	3.6	36	25	33	5.9	59	42
7	1.3	13	9	21	3.8	38	27	34	6.1	61	43
8	1.4	14	10	22	4.0	40	28	35	6.3	63	44
9	1.6	16	12	23	4.1	41	29	36	6.5	65	46
10	1.8	18	13	24	4.3	43	31	37	6.7	67	47
11	2.0	20	14	25	4.5	45	32	38	6.8	68	48
12	2.2	22	15	26	4.7	47	33	39	7.0	70	49
13	2.3	23	17	27	4.9	49	34	40	7.2	72	51
14	2.5	25	18								

5 First steps

Setup and installation



PLEASE NOTE

Comply with the specifications of the technical manual during setup and installation. This contains all building-side requirements.

Record of installation and setup

The record of installation and setup is to be completed by the responsible stockist and a copy sent to MELAG as proof of the correct setup, installation and initial commissioning. This is a constituent part of any guarantee claim.

Water supply

The [▶reprocessing](#) of medical devices requires the use of potable water in accordance with the Drinking Water Ordinance.

The potable water supply is effected on the input side via the house supply.

The quality of the water used for reprocessing influences the value-retention of the [▶load](#). Silicate or chloride cannot be removed by the internal water softening unit and will result in the development of stains and corrosion. Working in consultation with specialist associations (e.g. in Germany [▶AKI](#), [▶DGSV](#), [▶DGKH](#)) MELAG recommends performing a final rinse with demineralised water (DI water).



PLEASE NOTE

The final rinse and the partial cycle Disinfection are the same in MELAtherm.

During installation, it is determined whether DI water is to be used in the final rinse (partial cycle Disinfection). In addition, depending on customer-specific requirements, the service technician can parametrise the partial cycles pre-cleaning, cleaning, neutralising and intermediate rinsing to DI water. The DI water supply is effected via a water treatment unit (e.g. MELAdem 53/53 C).

Increased requirements can be placed on the quality of the [▶DI water](#) (e.g. a low endotoxin content) for the [▶reprocessing](#) of certain medical devices such as ophthalmic instruments.

Note the following:

- In such cases, an additional filter system is required for the reprocessing of DI water. Comply with the specifications of the user documentation of your water treatment unit.
- It is possible that the drinking water has been contaminated by the water installation. This includes both the domestic installation and the entire upstream peripherals.
- Arrange for a check of the drinking water quality at the removal point or request a report (e.g. from the building management) before setting up and installing the device.
- Further information is available from the corresponding trade associations and their publications. If in doubt, contact your stockist or the pertinent professional association.

Switching the device on and off

- ▶ Switch the device on or off at the power switch.



Video tutorials

The **Multimedia** menu contains video tutorials which describe the use of this washer-disinfector in a number of operating situations.

View of the video control



Button	Description	Button	Description
1	Start/pause	4	Close video
2	Fast forward	5	Sound louder
3	Fast reverse	6	Sound quieter

Access a video as described below.

The following must be fulfilled or present:

- ✓ The device is switched on and the display is in the main menu.

1. Repeatedly press **FORWARDS/BACK** until the **Multimedia** menu is displayed.

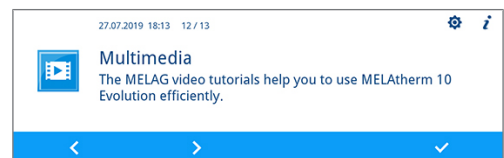

2. Press **CONFIRM** to open the menu.
 - ➡ The first tutorial page is displayed.

3. Press **FORWARDS/BACK** until the desired tutorial is displayed.

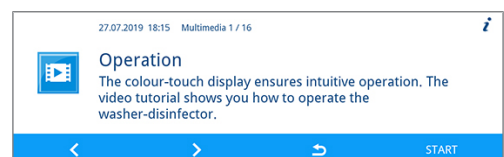

4. Press **START** to start the video.



↪ The started video will play once.

5. Close the video to return to the media library.

MELAconnect App

You can use the MELAconnect app from any location in your practice, to access the device status and program progress of the MELAG devices incorporated in your practice network.

MELAconnect provides the following functions:

- Accessing the device status and program progress
- Accessing the user manuals and video tutorials for using the device
- Locating malfunctions and accessing solutions and assistance immediately
- Performing quick paperless documentation of routine checks of MELAG sealing devices
- Contacting the service technician (contact data must be entered manually)

In order to connect the MELAconnect app with your MELAG device, see the [Connectivity](#) [▶ page 57] section.

Opening and closing the door

The door is automatically closed via a motor. For this reason, it is important that the device is connected to the power supply and is switched on. The door unlocks automatically after a successful program run. The door cannot be opened during a power failure. In this case, operate the [Manual door emergency-opening](#) [▶ page 22].



PLEASE NOTE

The door can only be opened during a program run using a program abort.

The door will be unlocked after the program abort has been acknowledged and sufficient cooling has been performed.

Opening the door

1. Switch on the device at the power switch.
2. Press **UNLOCK** to unlock the door.
3. Open the door forwards.

Close the door

- ▶ Shut the door upwards and press it until the motorised lock sets in.

Manual door emergency-opening

The door can be opened manually via the emergency opening following a power failure or malfunction.

Note the following:

- Escaping steam brings the danger of scalding.
- Never operate the door emergency-opening mechanism during an active program.
- A program aborted by a door emergency-opening is classed as not having been completed successfully. The instruments must be reprocessed again.
- Wear suitable protective clothes.

Operating the door emergency-opening

1. If the device is still switched on, switch it off at the power switch.
2. Pull out the process agent drawer.
 - ↳ An emergency-opening grip for the door is located in the front left-hand side of the device.
3. Pull down on the grip until you hear a clicking sound.

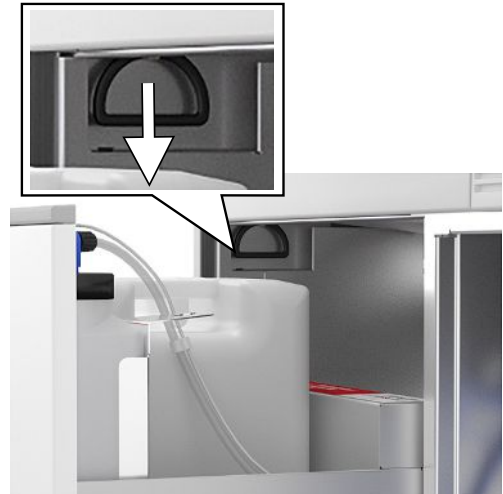

4. Pull the door forwards strongly using the grip.

Inserting the basis basket

A fitting for connecting the injector rail or the blind cap is located on the right-hand rear side of the washing chamber of the washer-disinfector.

- ▶ Slide the basis basket with the injector rail opening or the blind cap leading into the washing chamber until it connects to the fitting.

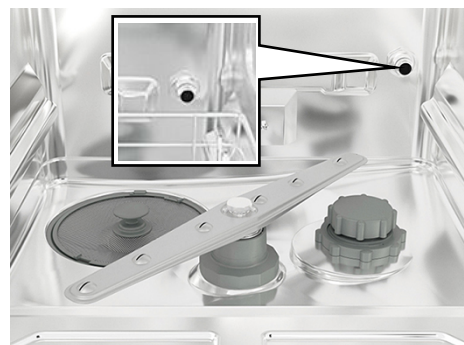

Filling the regenerating salt



NOTICE

Malfunctions of the water softening unit from unsuitable regenerating salt.

Fine grain regenerating salt can cause device malfunctions. MELAG does not recommend the use of pellets, as the salt dissolves too slowly.

- Use only special, coarse grain regenerating salt (additive-free NaCl).
- Never use cooking salt, table salt, de-icing salt, cattle salt or road salt. These salts usually contain insoluble components.

Filling the regenerating salt for the first time

The first filling of the regenerating salt is to be performed by the ▶authorised technician whilst commissioning the device.

Refilling with regenerating salt**Video tutorial**

See also “Refilling Regenerating Salt”.



Insufficient regenerating salt or its absence will result in the display of the corresponding display message.

- If the display shows the message **There is almost no regenerating salt left. Re-fill the regenerating salt soon.**, fill the regenerating salt immediately, or upon the display of the next message at the latest.
- If the display shows the message **The regenerating salt is exhausted. Re-fill the regenerating salt.**, you must fill the regenerating salt immediately. Otherwise you will be unable to start a further program.

You can refill the regenerating salt at any time without the display message previously having been shown.

- ▶ After filling, start the “Rinsing” program manually in order to rinse away any overflowed brine or salt residue from the washing chamber.

Proceed as follows to refill the regenerating salt:

1. Acknowledge the display message with **CONFIRM**.
2. Open the door.
3. Remove the basis basket.
4. Unscrew the screw cap of the salt container anti-clockwise.



5. Place the filling funnel for the regenerating salt on the opening and fill the salt container.



6. Remove the filling funnel and any excess salt residue from the washing chamber.



NOTICE

The salt has a corrosive effect on stainless steel. Salt residue must be removed from the washing chamber and the screw cap of the salt container be closed tightly to protect the instruments and the device.

- Salt residue on the sealing ring leads to leaks. Ensure that the sealing ring is clean before screwing on the screw cap.

7. Screw the screw cap of the salt container tight.
8. Insert the basis basket.
9. Start the "Rinsing" program without (instrument) load.

Regenerating the water softening unit

The internal water softening unit regenerates automatically in certain intervals. The program run time is extended by a number of minutes. You can regenerate the water softening unit manually after e.g. having filled it with salt without a warning having previously been issued.

- ▶ To do so, start the "Regeneration" program.

Metering process agents

The concentration of the process agents is set once during the initial device setup performed by the services technician (see technical manual). During a program run, the preset concentration of the relevant process agents is metered automatically.

Holding process agents ready

Video-Tutorial

See also “Replacing Process Agents”.



CAUTION

Danger of chemical burns!

Inappropriate handling of the process agents can lead to chemical burns and injury to health.

- Comply with the information from the manufacturer of the process agents.
- In the case of damage, every type of liquids (e.g. in the drawer, in the device floor trough or liquid issued from the device) could potentially contain aggressive process agents.
- Protect your eyes, hands, clothing and all surfaces from contact with the process agents.

Note the following:

- Comply with the usage instructions, see [Process agents](#) [▶ page 10].
- Before commissioning or after a container exchange, you must bleed the metering system, see [Removing air from the metering system](#) [▶ page 28].
- The ▶[process agents](#) may not be allowed to mix when changing the product. Place the suction lances in a container with water and start the “Air removal” program.

The absence or insufficient filling level of a process agent will trigger the display of the corresponding message. In this case you must replace or refill the process agents container.

Containers for process agents

Every process agent has its own container and a suction lance with screw-on lid:

- ▶[Cleaning agent](#): 5 l container with a blue suction lance screw-on lid
 - ▶[Neutraliser](#): 5 l container with a red suction lance screw-on lid
 - ▶[Rinse aid](#): 1 l container with a black suction lance screw-on lid
- ▶ Place the container in the drawer in accordance with the process agent assignment. A container can only be closed correctly if the colour of the process agent matches that of the suction lance screw-on lid.

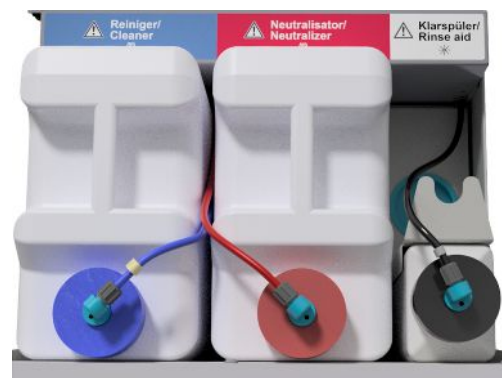

Replacing the containers for cleaning agent and neutraliser

1. Unscrew the suction lance from the container and place it in the suction lance bracket.

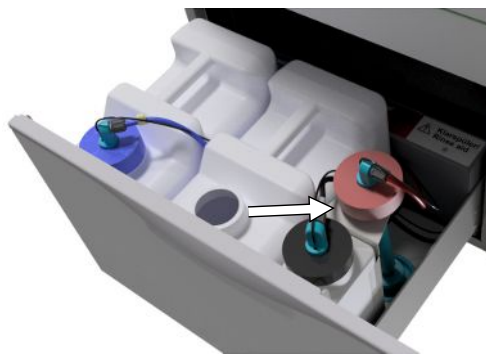

2. Place the new container in the process agents drawer and screw on the suction lance.

↳ The screw-on lid of the suction lance points forwards.

3. Remove the air from the metering system, see [Removing air from the metering system](#) [▶ page 28].

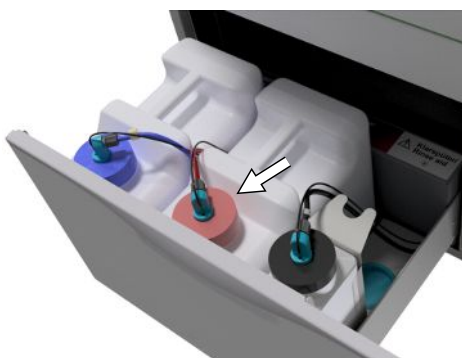

Refilling rinse aid



WARNING

When ▶reprocessing ophthalmologic instruments ▶rinse aid may not be used, see [Reprocessing ophthalmological instruments](#) [▶ page 31].



PLEASE NOTE

A streaky instrument surface could be caused by too much rinse aid.

Proceed as follows to fill an empty container with rinse aid:

1. Unscrew the suction lance from the container and place it in the bracket behind it.

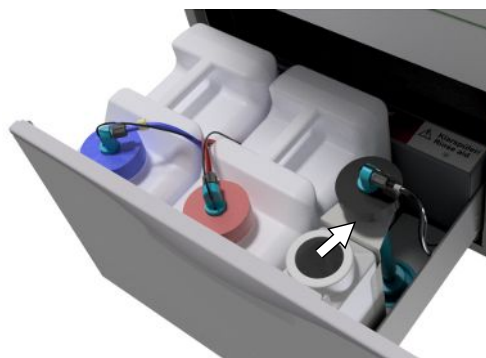

2. Transfer the rinse aid from the original packaging into the MELAG container.
 - ↳ Fill the container with rinse aid $\frac{3}{4}$ full, otherwise the rinse aid will overflow during insertion of the suction lance.
3. Screw the suction lance onto the container.
4. Remove the air from the metering system, see [Removing air from the metering system](#) [▶ page 28].

Removing air from the metering system

Air must be removed from the metering system during commissioning or after removal of the suction lances. The “Air removal” function removes all air pockets from the hoses and ensures good metering.

The rinse aid suction lance not used for ophthalmic instruments must be inserted head-first in the suction lance bracket during the running of the “Air removal” program.

The “Air removal” program must be started after removing the suction lances or before the first reprocessing program.

1. If necessary, place the suction lance of the unused rinse aid head-first in the suction lance bracket.

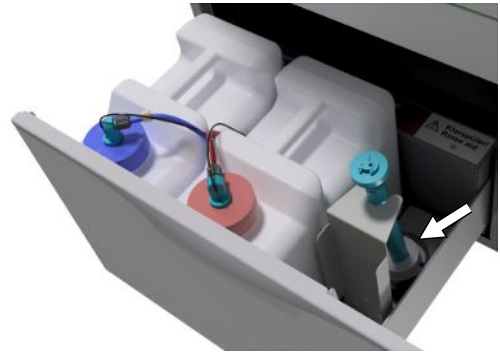

2. Repeatedly press **FORWARDS/BACK** until the “Air removal” program is displayed.

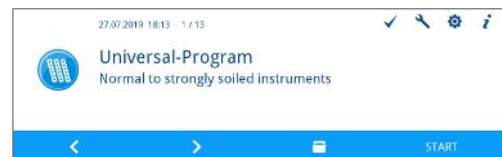

3. Press **START** to start the “Air removal” program.



6 Cleaning and disinfection

Type of load

When loading the device, observe the user manual Accessories for MELAtherm. Only use the loading pattern specified and approved within the scope of the validation.

This device can clean and disinfect max. 10 kg of the following type of ▶load:

- massive instruments
- hollow-body instruments e.g. aspirator tips, which are fixed to injector nozzles or
- transmission instruments e.g. handpieces and contra angles by using the adapter

Further accessories may be required when **reprocessing ophthalmological instruments** (not available from MELAG). The operator is responsible for validating the procedure in combination with special load accessories. It is especially important that feed lines to hollow-body instruments are maintained without kinking and as short as possible.

Wet/dry storage

Video tutorial

See also “Preparation of Instruments”.



- Store used instruments in a dry place. Ensure that they are stored protected from light and heat. Keep the storage duration as short as possible, according to AKI maximum 6 hours.
- Instruments which present organic residue (e.g. blood) after patient treatment could benefit from pre-soaking in a suitable treatment solution. Check that the process agent chosen for prior soaking is compatible with the washer-disinfector ▶[process agents](#). Otherwise, choose dry storage.
- If you perform pre-soaking, rinse the instruments thoroughly with running water before ▶[reprocessing](#) in the washer-disinfector to prevent the solution from entering the device.
- Instruments may not be soaked overnight in water. Soaking in ▶[demineralised](#)/distilled water is also associated with damage connected with treatment residue (blood etc.).

Preparation and pre-cleaning

- If instruments are to be subject to manual preparation for cleaning, ensure that no media or tools/resources are deployed which could damage their surface. Never use any aggressive cleaning agents, wire or brass wire brushes or metal scourers. Information regarding correct instrument reprocessing is available from your instrument manufacturer.
- Remove water-insoluble treatment substances (e.g. dental cement, root canal disinfectants, alginates or silicones) directly after use by manual cleaning. Consult the product data sheets of the treatment substances.
- Other substances can also necessitate manual pre-cleaning. These include ultrasound gels and other auxiliary substances.
- Check hollow bodies (transmission instruments, cannulas, etc.) for free passage. Observe the department-specific instructions in this manual.
- Disassemble dismountable instruments for reprocessing according to the manufacturer's instructions.
- Remove corroded or defective instruments. Crusted instruments must be subject to a basic cleaning or repair.
- ▶[KRINKO](#)/▶[BfArM](#) (2012) recommend that instruments of the risk class “Semi-critical B” and “Critical B” are subjected to pre-cleaning directly after use.
- The complete cleaning and disinfection of surgical aspirators requires manual pre-cleaning of the interior lumen. Subsequent suction (e.g. using the dental unit) of a minimum of 200 ml water through the surgical aspirator immediately or 10 min (at the latest) after treatment will achieve sufficient pre-cleaning. A comparable or more intensive pre-cleaning is permissible.

Arranging the load



NOTICE

Some brands are only authorised for thermal disinfection after a specific year of manufacture.

- Only reprocess instruments designed by their manufacturer for automatic reprocessing in a washer-disinfector.
- Comply with the information from the relevant instrument manufacturer.

In order to arrange the ▶load, the basis basket including insert racks, instrument baskets, wash trays and/or sieve cassettes must be used. The basis basket with an injector rail is available for ▶reprocessing hollow-body instruments.

Further accessories and their user instructions such as insert racks for wash trays, sieve cassettes and instrument baskets etc. are listed in the user manual Accessories for MELAtherm.

Note the following:

- Empty all residual liquids from containers before arranging them in the device. Rinse away any liquids (e.g. disinfectant solutions) thoroughly.
- Never place any individual instruments directly in the basis basket. Use baskets or trays to this end.
- Ensure that instruments do not protrude from the sides of the instrument basket or the basis basket. Protruding instruments can damage the seal and the surface of the door or the side walls of the washing chamber. The instruments can break.
- Place hollow-body instruments in the device in such a way as to ensure safe rinsing. If necessary, use the accessories developed especially for reprocessing hollow-body instruments such as injector nozzles, Luer connections, adapters etc. See user manual Accessories for MELAtherm.
- Avoid blockages of the rinse arm from instruments protruding upwards or downwards. The rinse arms must be able to rotate freely.
- Avoid unwashed areas. A good cleaning outcome depends on the correct arrangement of the instruments.
- Arrange all containers such as kidney dishes etc. with their opening pointing downwards.
- Place components with openings or compressions at an angle, so that the water can run off them.
- Only use thermostable instruments approved by their manufacturer for reprocessing.

Reprocessing hollow-body instruments



WARNING

Danger of contamination from insufficient disinfection

Residue on the hollow-body instruments can hinder water pass through and thus impair their disinfection.

- Check the hollow-body instrument for free passage before reprocessing.



WARNING

Danger of contamination from insufficient disinfection

All openings must be occupied when using multi-way distributors or the injector rail. Only then can a correct function be guaranteed.

- Seal non-used openings.



WARNING

Danger of contamination from insufficient disinfection

Use a filter insert for hollow-body instruments with an inside diameter ≤ 0.8 mm.

- Do not use the metal filter disc or the Cleanfinity filter in the ophthalmic area.
- Instead, use the ceramic filter disc or the plastic central filter.

Note the following:

- Comply with the specifications from the instrument manufacturer.
- Rinse all hollow-body instruments after use with patients or before automatic reprocessing.
- Reprocess only those hollow-body instruments which guarantee sufficient and reproducible rinsing. Remove instruments with a recognisably reduced throughflow.
- Use only MELAG adapters to [reprocess](#) hollow-body instruments on the injector rail. The suitability of a hollow-body instrument for the respective adapters and the sufficient rinsing can only be proven by validation.
- Check the connection between the adapter and the hollow-body instrument for stability both before and after reprocessing. Should the connection work loose after reprocessing, the instruments must be reprocessed again.
- Comply with the cleaning and replacement intervals when using filter inserts. The cleaning and replacement intervals can be found in the user manual Accessories for MELAtherm.
- When reprocessing dental and ophthalmologic transmission instrument, observe and comply with the special reprocessing instructions in [Reprocessing dental transmission instruments](#) [▶ page 31] and [Reprocessing ophthalmological instruments](#) [▶ page 31].

Rule for use of filters or filter discs:

Diameter of the inner lumen	Application of a filter
≤ 0.8mm	Filter required, e.g. triple distributor incl. ceramic filter disc (art. no. ME73903)
> 0.8mm	No filter required, direct connection of the adapter to the injector rail possible

Reprocessing dental transmission instruments

Note the following:

- Comply with the specifications from the instrument manufacturer.
- The exterior surfaces of the handpieces and contra angles should be free of all water-insoluble residue e.g. dental cement.
- The air and spray channels must be entirely clear.
- Prevent soiling from drying, especially on and in the handpieces and contra angles.
- Use a citric acid based [neutraliser](#) for the [reprocessing](#) of dental transmission instruments.
- Dry the hollow-body instruments after reprocessing using medical compressed air.

Care of the instruments and adapters

Immediately after successful cleaning and disinfection, re-dry the spray, air and water channels using medical compressed air. Carry out maintenance with suitable care products and oils.

Check the adapters for transmission instruments at regular intervals for possible soiling. If necessary, rinse the individual parts of the adapters under running water. Rub the silicone inserts of the universal adapters with a damp, non-fuzzing cloth.

Reprocessing ophthalmological instruments

Comply with national recommendations for the cleaning of medical products under the aspect of decontamination of infectious prion proteins (CJD).



WARNING

Danger of contamination from biological interactions.

Devices used to reprocess ophthalmologic instruments may only be used exclusively for this purpose.

- Do not reprocess any instruments used in retinal surgery (coming into contact with retinal tissue, subretinal fluid and the optical nerve).
- Fit these devices with a suitable filter system e.g. the ceramic filter disc or the plastic central filter.
- Do not use the metal filter disc or the Cleanfinity filter for the reprocessing of ophthalmological instruments.

**WARNING**

Do not use ▶rinse aid for reprocessing ophthalmic instruments!

1. If present, remove the rinse aid container from the process agents drawer and hang the black suction lance in the suction lance bracket so that the screw-on lid is positioned at the top.

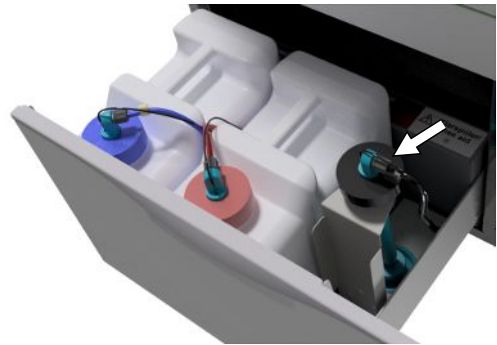

2. The process agent hoses only need to be placed head-first in the suction lance bracket if the metering hoses are to be bled, see [Removing air from the metering system](#) [▶ page 28].

**PLEASE NOTE**

Use demineralised water to reprocess ophthalmological instruments.

- To this end, e.g. connect a mixed-bed resin cartridge.

Suitable program

Reprocess ophthalmological instruments in the Ophthalmo-Program. Only this program enables monitoring of the water ▶conductivity during the disinfection phase; this ensures a residual conductivity which is uncritical for applications on both the eye.

Note the following:

- Comply with the specifications from the instrument manufacturer.
- Cleaning should be performed with a mildly-alkaline ▶cleaning agent. Neutralisation should be performed with a citric acid based ▶neutraliser.
- Rinse all hollow-body instruments with ▶DI water after use with patients or before automatic reprocessing.
- Reprocess only those hollow-body instruments which guarantee sufficient and reproducible rinsing. Remove instruments with a recognisably reduced throughflow.
- Connect all hollow bodies properly with the adapters provided.
- Ensure that plugs and/or cables from Phaco handpieces are not able to slip through the basis basket, otherwise the rinse arm can become blocked.
- Try to prevent soiling from drying or encrusting on and in the instruments.
- Dry the ophthalmological instruments after reprocessing using medical compressed air.
- When using rinsing systems, seal individual outlets which are not connected with suitable accessories.

Instrument care

Comply with the manufacturer's instructions regarding the care and maintenance of the instruments / the load accessories.

Routine check

Perform a routine check of the ►pH value after reprocessing of the hollow-body instruments.





1. Blow through the hollow-body instrument with medical compressed air onto indicator paper (e.g. from Macherey-Nagel: PEHANON pH 4.0-9.0). The measurement accuracy must amount to or exceed 0.5.
2. Compare the value displayed on the indicator paper with the pH value of the final rinse water from the previous performance qualification.
3. Should you discover any deviations, contact the customer services.

Overview of programs







Select the program according to the level of soiling of the ►load. Comply with the specifications from the validation.

Use the Universal-Program predominantly in everyday general cleaning and disinfection. The Quick-Program is designed for lightly soiled instruments.

The following table lists the correct program for each load.

Reprocessing program	Symbol	Nature of the instruments / degree of soiling	Operating time ^{*)} without drying time	
			DTA	DTB
Universal-Program ¹⁾		<ul style="list-style-type: none"> ▪ For normal to heavily soiled instruments 	42 min	63 min
Quick-Program		<ul style="list-style-type: none"> ▪ For unsoiled or lightly soiled instruments 	37 min	57 min
Intensive-Program		<ul style="list-style-type: none"> ▪ For especially heavily soiled instruments ▪ Like the Universal-Program, but with a longer cleaning time 	54 min	67 min
Ophthalmo-Program		<ul style="list-style-type: none"> ▪ For ophthalmology instruments ▪ Like the Universal-Program, but with a longer cleaning time, double intermediate rinsing without rinse aid 	43 min	63 min

^{*)} The specified operating times are average values and apply to the recommended running water pressure at a cold water temperature of 15 °C.

Additional program	Symbol	Application	Operating time ^{*)}
Rinsing		<ul style="list-style-type: none"> ▪ For rinsing strongly soiled instruments (e.g. blood) A disinfection program must then be started. ▪ To rinse out the washing chamber after filling salt; without process agents, no disinfection 	3 min
Emptying		<ul style="list-style-type: none"> ▪ Pumping out residual water from the washing chamber 	1 min
Conductivity measurement DI		<ul style="list-style-type: none"> ▪ For measuring the conductivity of the DI water 	2 min
Air removal		<ul style="list-style-type: none"> ▪ After filling / changing the process agents, i.e. product change etc. ▪ With decommissioning and commissioning 	5 min
Regeneration		<ul style="list-style-type: none"> ▪ Regenerating the internal water softening unit 	8 min
Time metering 60 s		<ul style="list-style-type: none"> ▪ Only for service technicians 	--

^{*)} The specified operating times are average values and apply to the recommended running water pressure at a cold water temperature of 15 °C.

¹⁾ In accordance with the A0 concept from EN ISO 15883-1, thermal disinfection is performed with 90 °C (+ 5 °C, - 0 °C) and an application time of 5 min (min. A0-3000).

Selecting, starting and monitoring the program

Ensure compliance with the following prerequisites in order to secure the optimal rinsing performance before every program start:

- The process agents containers are sufficiently full.
- The injector rail nozzles / adapters are clean.
- The rinse arms can be turned freely.
- The load is arranged correctly.
- Baskets and inserts are inserted correctly.

Selecting and starting a program

Video tutorial

See also "Selecting Program".



1. Select a program in accordance with the [program overview](#) [▶ page 33].
2. Navigate to the desired program with **FORWARDS/BACK**.

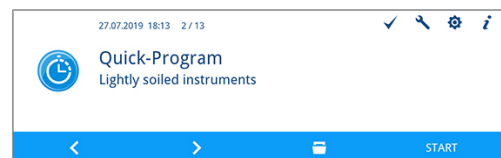

↪ The display shows the program names and the type of reprocessing for which the program is suitable.

3. Press **START** to start the selected program.

Monitoring the program run on the computer

You can monitor the current progress of a program run on every computer in the (practice) network. To do so, an IP address must be issued for the device and it must be incorporated in the (practice) network.

1. Open a web browser window in the practice PC (Mozilla Firefox or Internet Explorer / Microsoft Edge is recommended).
2. Enter the device IP address in the address bar of the web browser, e. g. 192.168.70.206 and confirm with Enter.

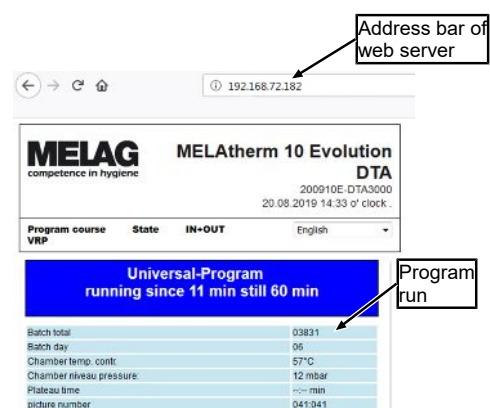

↪ The program run and the device information such as e. g. serial number and device software version will be displayed.

Manual program abort



NOTICE

Aborting a current program by deactivation at the power switch may cause damage at the device.

- Never abort a program by switching off at the power switch.

Aborting the program during drying



WARNING

Nucleation because of poor drying.

If a program is aborted during drying, residual dampness can remain on the instruments.

- Only abort a current program in exceptional reasons.
- Dry the instruments manually.



CAUTION

Danger of burns from hot instruments and surfaces.

The instruments and chamber can remain hot even after the device has been switched off.

- Allow the device to cool before removing the instruments.
- Wear suitable protective gloves.

If you abort a program during drying, the program is considered as having been ended successfully.

Aborting the program during drying:

1. Wait until **Partial cycle: Drying** is displayed.

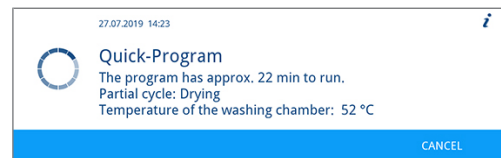

2. Press **CANCEL** and confirm the abort with **YES**.

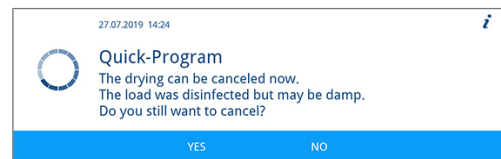

3. Press **UNLOCK** to open the door.

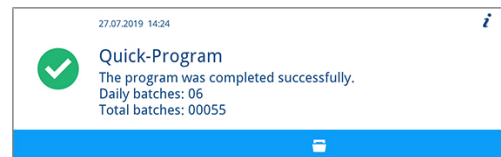

Aborting the program before the start of drying



WARNING

Danger of contamination through program abort!

Aborting a program before the drying phase begins means that the load is classed as not having been disinfected. This endangers the health of the patient and the practice team.



CAUTION

Danger of burns from hot instruments and surfaces.

The instruments and chamber can remain hot even after the device has been switched off.

- Allow the device to cool before removing the instruments.
- Wear suitable protective gloves.

If you want to abort a running program before drying starts, press **CANCEL** and follow the instructions on the display.

Authentication and batch approval

Authentication

Authentication is used for personalised removal of the ▶load from the device with or without subsequent batch approval. If authentication has been activated and the reprocessing program completed successfully, you will automatically be asked to enter your user PIN. Your user ID is shown in the log.

Batch approval

The batch approval following program end is used to assess and log the outcome of the ▶reprocessing (batch approved/not approved). The ▶batch is assessed by the user on the basis of various criteria (e.g. degree of cleaning and drying, position of the load, etc.).

In order to be able to carry out batch approval (with or without authentication), this must be activated. You will be automatically requested to perform batch approval after successful completion of the reprocessing program.

Batch assessment and approval with authentication

Once the reprocessing program has been completed successfully, you will automatically be asked to assess the batch and provide it with approval.

The following must be fulfilled or present:

- ✓ Authentication is activated, see [Authentication](#) [▶ page 62].
- ✓ Batch approval is activated, see [Batch approval](#) [▶ page 63].
- ✓ The reprocessing program has been completed successfully.

1. Press **UNLOCK**.

➔ The **user PIN** view is displayed.

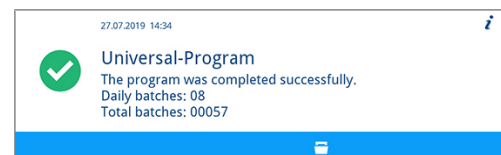

2. Enter your four-digit user PIN and press **CONFIRM**.

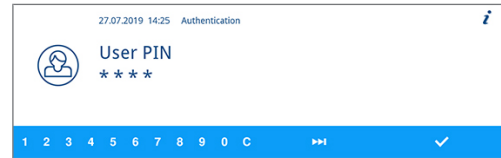

- ↳ The door is unlocked.
- ↳ The **Approve batch** view is displayed.

3. Press **DETAILS** for information for the batch approval assessment criteria.

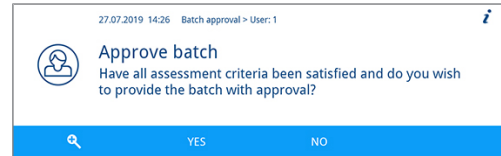

4. Press **FORWARDS** and read all the assessment criteria carefully. Check the reprocessed batch using the assessment criteria outlined.

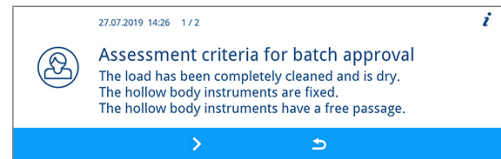

5. Press **LEAVE** to switch to **Approve batch**.

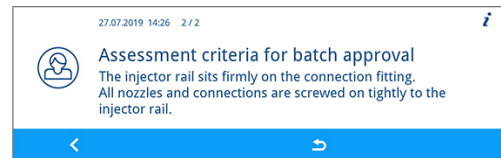

6. Press **YES** if the assessment criteria are met.

Press **NO** if the assessment criteria are not met.



↳ The log will show **User ID: ##** and **Batch approved: YES** or **NO**.

Batch assessment and approval without authentication

Batch assessment without authentication can only be performed if batch approval is activated and authentication is deactivated. If this is the case, you will not be prompted to enter your user PIN before batch assessment.

The following must be fulfilled or present:

- ✓ Authentication is deactivated, see [Authentication](#) [▶ page 62].
- ✓ Batch approval is activated, see [Batch approval](#) [▶ page 63].
- ✓ The reprocessing program has been completed successfully.

1. Press **UNLOCK**.

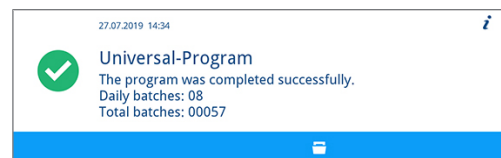

↳ The **Approve batch** view is displayed.

2. Press **DETAILS** for information for the batch approval assessment criteria.



3. Press **FORWARDS** and read all the assessment criteria carefully.
Check the reprocessed batch using the assessment criteria outlined.

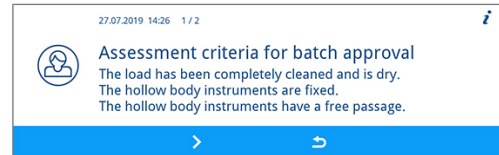

4. Press **LEAVE** to switch to **Approve batch**.

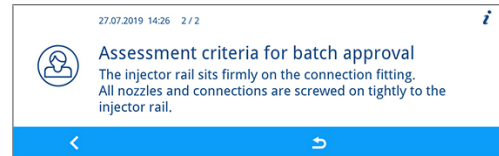

5. Press **YES** if the assessment criteria are met.
Press **NO** if the assessment criteria are not met.

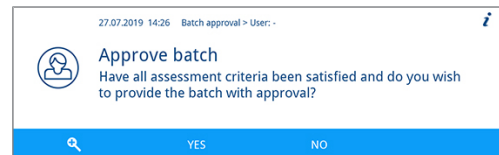

→ The log shows **User ID: DEACTIVATED** and **Batch approved: YES OR NO**.

Authentication without batch approval

If an automatically documented batch assessment and approval is not desired, then there is the option of an authenticated removal of the load. In this case, the fact of the reprocessed load having been removed by an authenticated user will be documented.

The following must be fulfilled or present:

- ✓ Authentication is activated, see [Authentication](#) [▶ page 62].
- ✓ Batch approval is deactivated, see [Batch approval](#) [▶ page 63].
- ✓ The reprocessing program has been completed successfully.

1. Press **UNLOCK**.

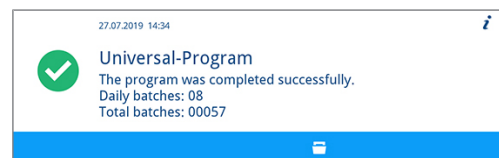

→ The **User PIN** view is displayed.

2. Enter your four-digit user PIN and press **CONFIRM**.

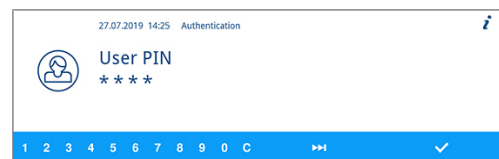

→ The door is unlocked and can be opened.

→ The log shows **User ID: ##** and **Batch approved: DEACTIVATED**.

Skip authentication

If both batch approval and authentication have been activated, you will automatically be requested to assess the batch and provide it with approval after the reprocessing program has been completed successfully. You have the option to skip the authentication and continue in the process.



PLEASE NOTE

Skipping authentication means that the batch will automatically be evaluated as not having been approved.

You can document the assessment separately and continue in the prescribed practice process.

The following must be fulfilled or present:

- ✓ Authentication is activated, see [Authentication](#) [▶ page 62].
- ✓ Batch approval is activated, see [Batch approval](#) [▶ page 63].
- ✓ The reprocessing program has been completed successfully.

1. Press **UNLOCK**.

➔ The **User PIN** view is displayed.

2. Press **SKIP**.

➔ The confirmation prompt **Skip authentication** is displayed.

3. Press **YES**.

➔ The door is unlocked.

➔ The **Door unlocked** view is displayed.

4. Open the door.

➔ The log shows **User ID: Skipped** and **Batch approved: NO**.

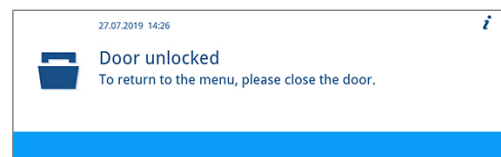
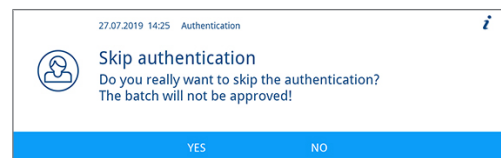
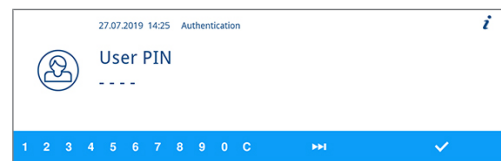
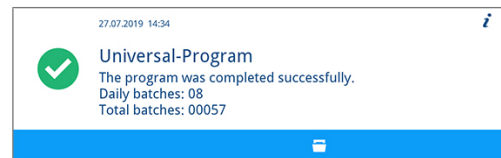

Removing the load after program end



CAUTION

Danger of burns from hot instruments and surfaces.

The instruments and chamber can remain hot even after the device has been switched off.

- Allow the device to cool before removing the instruments.
- Wear suitable protective gloves.



PLEASE NOTE

Open the door immediately after the end of the program to prevent the accretion of condensation.

Do not leave any instruments in the washing chamber overnight.

The display message indicates whether and when a program has been completed successfully. The display shows the last batch number and the total batch counter after every program end or the end of a program abort.

1. Press **UNLOCK** and open the door.

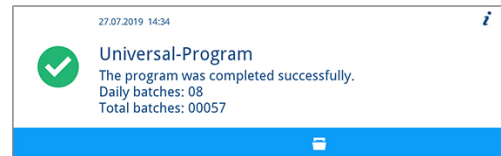

2. Remove the load whilst complying with all the hygiene and working safety regulations.
3. Check whether the load has been cleaned successfully.

7 Logging

Batch documentation

The batch documentation serves as proof of the successful conclusion of the program and represents an obligatory part of quality assurance. The device internal log memory saves such data as the program type, ▶[batch](#) and process parameters of all the programs completed.

To obtain the batch documentation, you can output the internal log memory and transfer its data to various output media. This can be performed immediately at the end of every program or at a later point, such as at the end of the day.

As delivered, the MELAflash CF card is set as the output medium. Setting a different output medium or activating the internal log memory is outlined under [Settings](#) [▶ page 48].

Capacity of the internal log memory

The device is equipped with an internal log memory. This saves all the data regarding the program automatically. The capacity of the internal log memory is sufficient for 15-20 logs. If the internal log memory is full, the display will show **The internal log memory is full. Please output all logs via log output in the main menu.** If this warning is issued, provide the specified output medium (see [Settings](#) [▶ page 48]) and output the affected log (see [Log settings](#) [▶ page 49]). If the program is continued, the logs are deleted automatically; the last ten saved logs remain in the log memory.

MELAG recommends outputting logs immediately.

Output media

You can output the logs of the finished programs via the following output media:

- MELAflash CF card
- A computer via the (practice) network (LAN)
- MELAprint 42/44 log printer with network adapter

The output media can be combined in any fashion. Thus it is possible both to save logs on the CF card (included in the scope of delivery) and also to print them on the log printer.



PLEASE NOTE

Further information about the log printer (e.g. the duration of the readability of the log printouts) is specified in the appendant user manual.

Using the CF card as an output medium

Video tutorial

See also “Batch Documentation”.



Inserting the CF card

The card slot for the ▶[CF card](#) is located behind the cover cap on the right, adjacent to the door below the power switch. When inserting the CF card in the slot, ensure that it is aligned correctly.

1. Open the CF card cover cap.

2. Insert the CF card in the slot with the contacts at the front. The MELAG lettering on the CF card points towards the LED.



3. Slide the CF card in the card slot until it clicks. Do not use force. When the CF card has been placed correctly, the red LED will illuminate shortly.
4. Close the cover cap.

Removing the CF card



NOTICE

Premature removal of the CF card from the card slot or its inappropriate handling can result in data loss, damage to the CF card or the device.

- Never remove the CF card from the slot whilst it is being written or read.

1. Open the CF card cover cap.
2. Press the ejection button and remove the CF card.
3. Close the cover cap.

Using the computer as an output medium

You can either connect a computer directly to the device or via a network if the following conditions are fulfilled:

- The computer is fitted with a network card with a RJ45 bushing (LAN).
- An FTP server or an FTP service is installed on the computer (when the log is issued via FTP).
- A suitable program, e.g. MELAtrace/MELAviiew, is installed (when the log is issued via TCP).

Working in the **Settings** menu, you can perform or change network settings, see [Log settings](#) [▶ page 49].

Outputting logs immediately and automatically

When the device is delivered, the MELAflash CF card is set as an output medium in the **Settings** menu and thus the automatic log output at the end of a program (immediate output = **yes**) is thus activated. Log output on multiply activated media is performed successively. You can select or add an alternative output medium for automatic log output, see [Log settings](#) [▶ page 49].

Text logs

The following requirements must be fulfilled in order to output text logs immediately after the end of a program:

- In the **Settings > Log settings > Immediate output** is set to **yes**.
- In the **Settings > Log settings** a minimum of one output medium has been selected and **Immediate output** has been set to **yes**.
- The activated output medium is available (e.g. the MELAprint 42/44 log printer or CF card).

Graphic logs (optional)

The following requirements must be fulfilled in order to record graphic logs:

- In the **Settings > Log settings > Graphic logs** at least one output medium is set to **yes**.
- At least one of the output media selected for graphic logs corresponds to an output medium for the text log. This means that at least the computer or the CF card must be activated as an output medium for both log types.
- The selected output medium has been connected.



PLEASE NOTE

Graphic logs cannot be saved in the internal log memory and cannot be outputted via the log printer MELAprint 42/44.

- Save the graphic log on the CF card or the computer.

Note the following:

- The text log is issued on the selected output medium after the end of the program run. At the same time, this text log is saved in the internal log memory and marked as output.
- If multiple output media have been activated, all activated output media must be connected to the device. Otherwise, the text logs are saved in the internal memory and are classed as not output.
- If the internal log memory is almost full, the device will register all the text logs which are classed as not output. The warning message 386 appears after the program start. You can acknowledge this message by pressing **CONFIRM** and continue the program run.
- With warning message 372, you must manually output logs that have not yet been output. Only then is a program start possible. The log memory is deleted automatically after manual issue; the last ten logs remain in the log memory. The manual outputting of logs is outlined under [Subsequent log output](#) [▶ page 43].

Subsequent log output

The **Log output** menu provides the option of issuing logs subsequently and independently of the point of the program end.

1. From the main menu, press **FORWARDS/BACK** until the **Log output** menu is displayed.
2. Press **CONFIRM** to open the menu.
3. Press **FORWARDS** until the desired output medium (CF card, MELAprint, Computer, automatic) is displayed.

If you want to apply the settings from the **Log settings** menu, select the output medium **automatic**.
4. Press **CONFIRM** to select the displayed output medium.
5. Press **FORWARDS** until the desired log type, e.g. **Last log**, **All malfunction logs**, is displayed.
6. Press **OUTPUT** to start the log output.

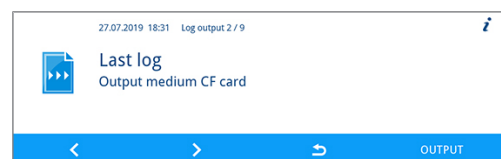
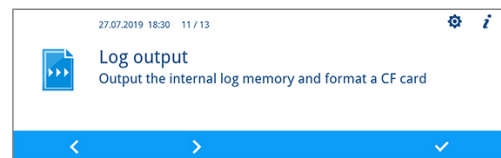

Deleting the saved logs

1. Save the logs on an output medium before deleting them.
2. From the main menu, press **FORWARDS/BACK** until the **Log output** menu is displayed.
3. Press **CONFIRM** to open the menu.
4. Press **CONFIRM** again.
5. If necessary, press **FORWARDS/BACK** until **All logs** is displayed.
6. In the context menu, press **DELETE**.

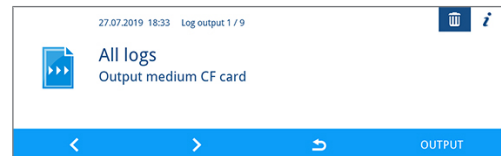
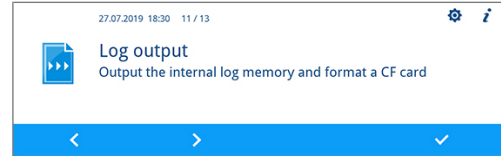

➔ The confirmation prompt is displayed **Delete all internal log memory logs?**

7. Press **YES** to delete all logs.

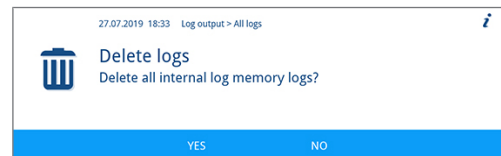

Determining the format for the program logs

The log format enables you to determine which of the data saved in the log memory is to be outputted. You can choose between the formats **0**, **1** and **2**. The log format **2** is the standard format. Working in the **Settings** menu, you can select the log format for the program log (see [Log settings](#) [▶ page 49]).

You can choose between the following format:

Format	Description
0	Short log: Only the log header is outputted.
1	Short log with program steps: The log header and the program steps are outputted.
2	Standard log: In addition to the log header and the program steps, a legend is displayed explaining the individual program steps. Logs outputted via the MELAprint log printer always contain a legend row located under the row to which it refers.

Log types

In addition to logs for successfully completed programs, there are other types of log. These can also be outputted via the selection list in the **Log output** menu. You can identify the log type by the ending of its file name.

Ending	Stands for	Explanation
.PRO	Program log	Log of a successfully completed program
.GPD	Graphic log	A log in which the processes are recorded graphically
.STR	Malfunction log	Log of an aborted program
.STB	Malfunction in standby	Log with malfunctions without a program having run
.LOG	System log	List of all the malfunctions and changes to the system in order of time (log book)
.STA	Status log	Summary of all the important settings and system states (counter, measured values etc.) + a list of all process-relevant parameters (VRP)
.LEG	Legend log	Contains all step abbreviations used in the program log
.DEM	Demo log	Log of a program simulated as completed in DEMO mode (only for presentation purposes)
.DES	Demo malfunction	Log of a program simulated as interrupted (presentation)

Example of a program log for a successfully completed program

```

-----
10 MELAG MELatherm 10 Evolution DTA
-----
15 Program : Universal-Program
20 TARGET °C min
21 Pre-clean: 22.0 03:30
23 Cleaning : 55.0 10:00
28 Desinfect: 90.0 05:00
30 Date : 19.07.2019
35 Batch : Day:10 Total:00071
36 User ID : 1
37 Batch approved: Yes
=====
40 Program successfully completed
=====
50 ACTUAL °C +/- K min
51 Pre-clean: 26.9 +1.0/-1.0 03:30
53 Cleaning : 57.5 +0.3/-0.2 10:00
58 Desinfect: 92.2 +0.2/-0.2 05:00 4152
-----
60 Conduct. : 7.2 (---) µS/cm
65 Start : 12:27:59
70 End time : 13:35:26 (67:27 min)
=====
80 SN:201910E-DTA0104
=====
81 Firmware : V3.013 18.07.2019
82 Parameter: V3.010 26.06.2019
83 BO : V3.524 24.05.2019
85 Release : V3.0.15 25.06.2019
-----
Step Start End Time °C ml mbar
--> Process start
...
--> Pre-cleaning
...
--> Cleaning
...
--> Neutralization
...
--> Intermediate rinsing
...
--> Disinfection
...
--> Drying
...
--> Process end
...
-----
>> Never change code in following row <<
0100002C1B4802BE0306064C0B3C0AD0130D9610
07BD3EFECA15229618881B257A98850427217323
930815C1C892292E3965C071864442576F5F38AC
648A82A3945A3D404141440157A94648AE494AEC
>> Proof of authenticity batch log <<
-----
Voltage max/min: 225/214
CW:33.0 DI: 7.0
0.0 0.0 -0.00 0.0
--et1---et2---eps---etu-----END

```

```

-----
10 Log header: Device name
-----

```

```

15 Program name
20 Column heading for 21-28
21 Nominal value temperature and holding time
23 Nominal value temperature and holding time
28 Nominal value temperature and holding time
30 Date
35 Daily and total batch counter
36 User ID and authentication
37 Status batch approval
=====

```

```

40 Control message
=====
50 Column heading for 51-58
51 Nom. value temp. range and holding time
53 Nom. value temp. range and holding time
58 Nominal value temp. conditions, A0 value
-----

```

```

60 DI water conductivity for final rinse
65 Time at program start
70 Time at program end
=====

```

```

80 Device serial number
=====

```

```

81 Installed firmware version
82 Installed parameter version
83 Installed user interface
85 Release version
-----

```

```

Step = Program step
Start = Time at start of partial cycle
Ende = Time at end of partial cycle
Time = Time (mm:ss), required by a partial cycle
°C = Temperature of the rinse liquor in the washing
chamber in degrees Celsius
ml = Quantity of cold water and DI water, respective
process agent consumed during a program step
mbar = Rinse pressure
92 = Up to five warnings
95 = Event number upon program abort

```

```

-----
Proof of authenticity:
Must never be changed; permits inference that the data
was created on a MELAG device and has not been
changed.
-----

```

```

-----
Sensor measurement values are displayed following a
malfunction. The values are helpful for a service
technician.

```

Finding the logs



PLEASE NOTE

Do not rename the directories, otherwise logs will be stored in both the renamed directory as well as the device directory which the device generates automatically.

All memory media (CF card or computer) contain a directory with the encoded serial number of the device concerned following log output. The directory name consists of five characters identical with the first five characters of every log, e.g. CR0ZH. This directory contains sub-directories with the month of log generation e.g. 01_2020 for January 2020. This contains all logs generated by the device in this month. The device directory is entered in the main directory on the CF card.



The device checks the memory medium after every type of log output (immediate output after a completed cycle or the transfer of multiple logs simultaneously). Should a directory not exist, it automatically creates a directory for the device and the month. If logs are outputted on the same memory medium more than once, a duplicate directory will be created under the device directory in which these logs will be saved only once.

Given direct log transfer to a computer, set the memory location in the program (FCP, FTP) used on your computer.

8 Settings

Settings menu

In the **Settings** menu, parameters such as date, time, display brightness, etc. can be set. The general procedure for making settings is described below.

Opening the menu

1. From the main menu, press **FORWARDS/BACK**, until the **Settings** menu is displayed.

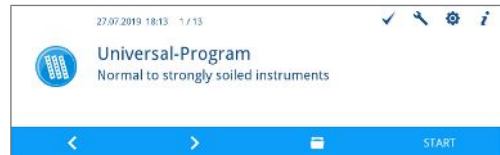

2. Press **CONFIRM** to open the **Settings** menu.

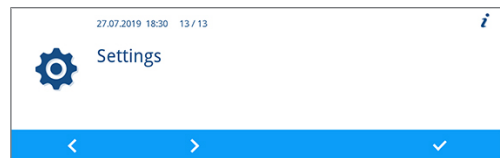

Making settings

The following must be fulfilled or present:

- ✓ The desired submenu is opened.
1. Press **EDIT** in the menu.
 - ➔ The parameter appears in light blue. You can make or change settings.
 2. Press **CONFIRM** to accept the setting.
 - ➔ The parameter appears in dark blue.
- ➔ The setting is completed.



PLEASE NOTE

Not all settings made are automatically saved immediately, but only when you exit the **Settings menu.**

Some settings require a system restart. The restart is carried out automatically after the settings have been saved.

Exiting the menu

1. Press **LEAVE** in the menu.
2. Press **YES** to exit the **Settings** menu.

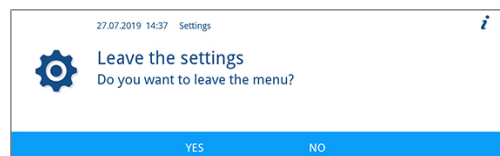

3. Press **YES** to save the settings.
Press **NO** to discard the settings.

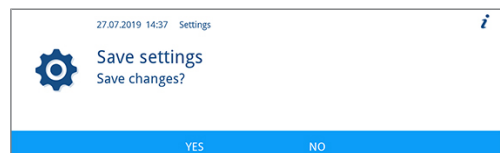

Log settings

You can define settings for automatic logging in the **Log settings** submenu. Detailed information regarding logging is provided in chapter [Logging](#) [▶ page 41].

1. From the **Settings** menu, press **FORWARDS/BACK** until the **Log settings** submenu is displayed.

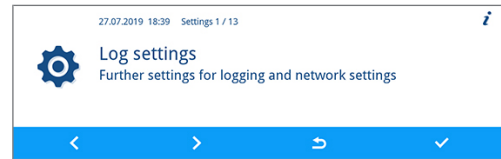

2. Press **CONFIRM** to open the submenu.

Selecting the output media

In the **Log settings** submenu, you have the option to select the output media for automatic logging.

The following example describes how to select a CF card as output medium. The selection of another or further output medium is done according to the same procedure.

The following must be fulfilled or present:

- ✓ The **Settings > Log settings** menu is open.

1. Press **FORWARDS/BACK** until **CF card** is displayed.

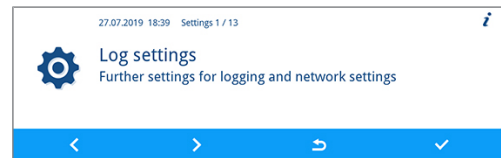

2. The parameter **yes** indicates that logs are automatically saved on the CF card.

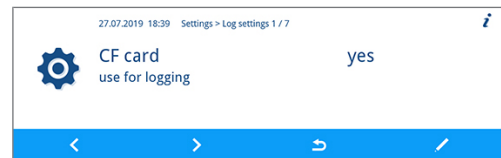

Press **EDIT** if the parameter is to be changed.

3. Press **FORWARDS/BACK** to switch between **yes** and **no**.

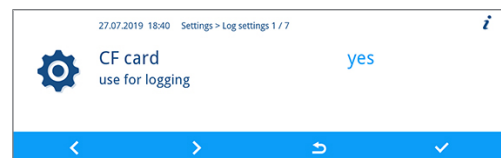

4. Press **CONFIRM** to accept the changes.

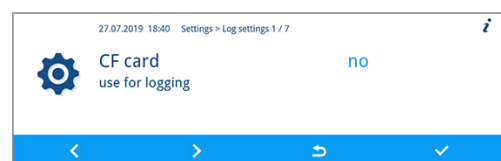

Immediate output

If you have specified an output medium for logging, you must also activate the immediate output. If the immediate output is not active, none of the previously determined output media is used for automatic logging.

The following must be fulfilled or present:

- ✓ The **Settings > Log settings** menu is open.

1. Press **FORWARDS/BACK** until **Immediate output** is displayed.

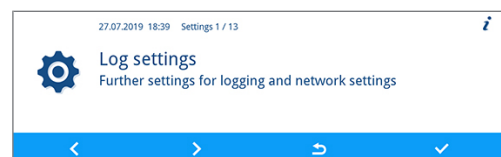

2. Press **EDIT** if the parameter is to be changed.



3. Press **FORWARDS/BACK** to switch between **yes** and **no**.



4. Press **CONFIRM** to accept the changes.



Determining log format

The following must be fulfilled or present:

✓ The **Settings > Log settings** menu is open.

1. Press **FORWARDS/BACK** until **Log format** is displayed.

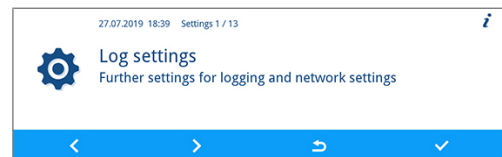

2. Press **EDIT** if the parameter is to be changed.

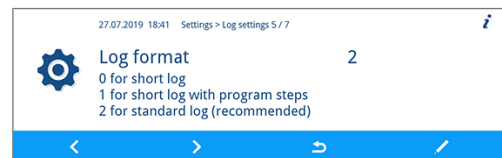

3. Press **FORWARDS/BACK** to switch between format **0**, **1** and **2**.

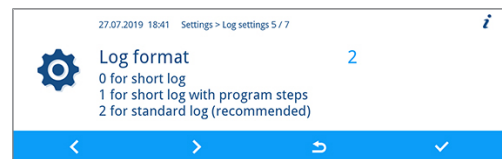

4. Press **CONFIRM** to accept the changes.

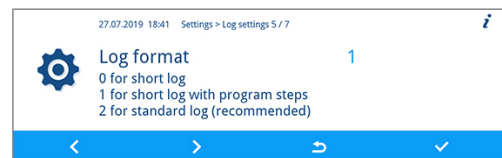

Detailed information regarding the log formats **0**, **1** and **2** is provided in [Determining the format for the program logs](#) [▶ page 44].

Setting the network



NOTICE

The setting up in the (practice) network will require in-depth understanding of the network technology. Handling errors of IP addresses can result in malfunctions and data loss in your user network.

- IP addresses may only be set by the (practice) network system administrator.

The network settings for logging can be changed in the **Network** submenu.

The following must be fulfilled or present:

- ✓ The **Settings > Log settings** menu is open.

1. Press **FORWARDS/BACK** until **Network** is displayed.

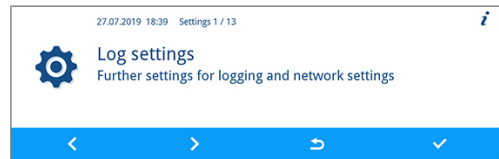

2. Press **CONFIRM**.

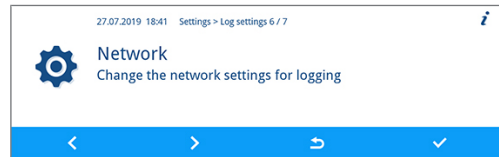

➡ Settings can be made for MELAtherm IP, connection type, FTP password, TCP port, computer IP, MELAprint-EDM IP, gateway IP and subnet mask.

MELAtherm IP, computer IP, MELAprint-EDM IP, gateway IP, subnet mask

The following describes how to set the MELAtherm IP. The other parameters are set according to the same procedure.

The following must be fulfilled or present:

- ✓ The **Settings > Log settings > Network** menu is open.

1. Press **FORWARDS/BACK** until **MELAtherm-IP** is displayed.

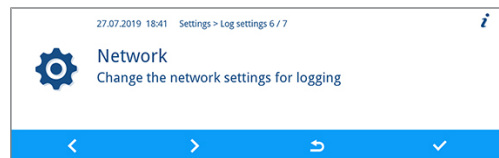

2. Press **CONFIRM** if a change is to be made.



3. Press **FORWARDS/BACK** to select the digit you want to change. The open arrow to the left of the digit indicates the current selection.

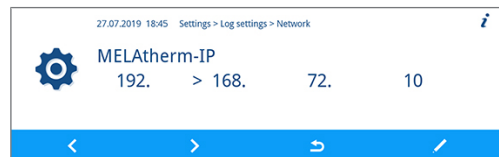

4. Press **EDIT**.

5. Press **FORWARDS/BACK** to change the digit.

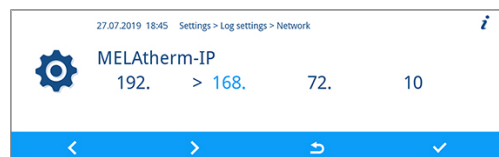

**PLEASE NOTE**

Holding the **FORWARDS** or **BACK** button pressed accelerates the increase or decrease.

6. Press **CONFIRM** to accept the changes.

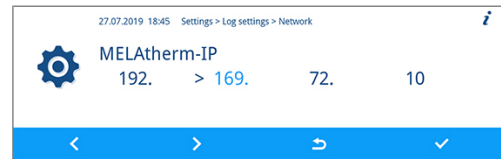

7. Repeat step 3 to 6 in order to edit more digits.

Type of connection

Working in the **Type of connection** window, you can choose between an FTP and an FTP/IP connection.

The following must be fulfilled or present:

- ✓ The **Settings > Log settings > Network** menu is open.

1. Press **FORWARDS/BACK** until **Type of connection** is displayed.

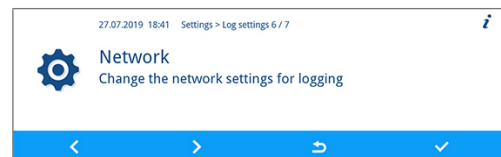

2. Press **EDIT**.



3. Press **FORWARDS/BACK** to switch between **0** (FTP) and **1** (TCP/IP).



4. Press **CONFIRM** to accept the changes.

**FTP password, TCP port**

The following describes how to set the FTP password. The setting of the TCP port can be done the same fashion.

The following must be fulfilled or present:

- ✓ The **Settings > Log settings > Network** menu is open.

1. Press **FORWARDS/BACK** until **FTP password** is displayed.

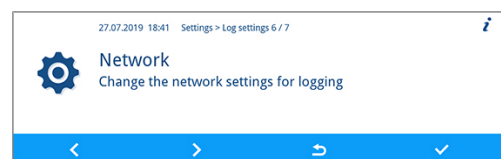

2. Press **EDIT**.

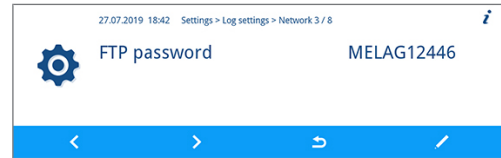

3. Press **FORWARDS/BACK** to change the parameter.

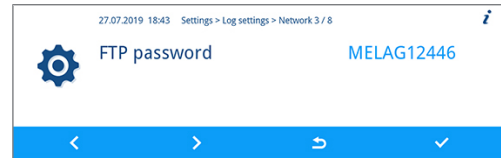

PLEASE NOTE

Holding the **FORWARDS** or **BACK** button pressed accelerates the increase or decrease.

4. Press **CONFIRM** to accept the changes.

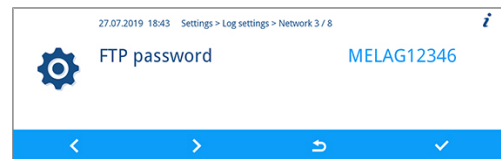

PLEASE NOTE

If the device is integrated in the (practice) network via a TCP connection, you will require a suitable program, e.g. MELAview/MELAt race.

Outputting graphic logs

In the **Graphic logs** submenu, you have the option of selecting the output media for the automatic logging of graphic logs.

The following describes how to set the CF card as the output medium. The selection of another or further output medium is done according to the same procedure.

The following must be fulfilled or present:

- ✓ The **Settings > Log settings** menu is open.

1. Press **FORWARDS/BACK** until **Graphic logs** is displayed.

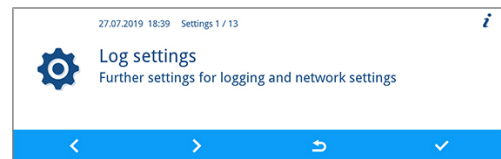

2. Press **CONFIRM** to open the submenu.



➡ Settings can be made for the output medium CF card and computer.

3. Press **EDIT**, to change the parameter **CF card**.

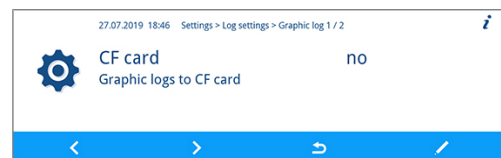

4. Press **FORWARDS/BACK** to switch between **yes** and **no**.

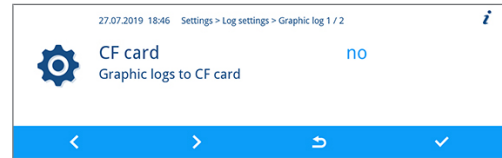

5. Press **CONFIRM** to accept the changes.

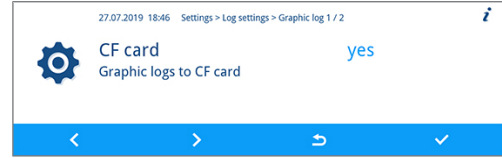

Setting the date and time

Date and time of the device must be correctly set for proper batch documentation.

Setting the date

The following describes how to set the Day parameter. The Month and Year parameters are set according to the same procedure.

The following must be fulfilled or present:

- ✓ The **Settings > Date** menu is open.

1. Press **CONFIRM** to open the submenu.

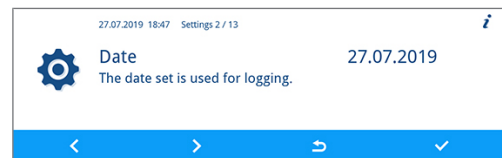

2. Press **EDIT**.



3. Press **FORWARDS/BACK** to change the parameter.

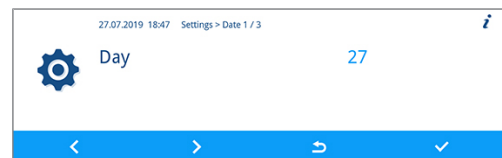

4. Press **CONFIRM** to accept the changes.

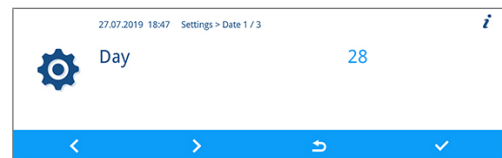

Setting the time

The following describes how to set the Hour parameter. The Minute parameter is set according to the same procedure.

The following must be fulfilled or present:

- ✓ The **Settings > Time** menu is open.

1. Press **CONFIRM** to open the submenu.

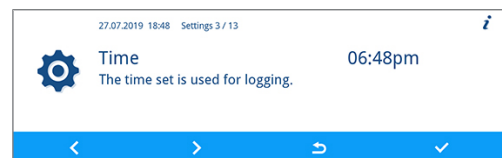

2. Press **EDIT**.

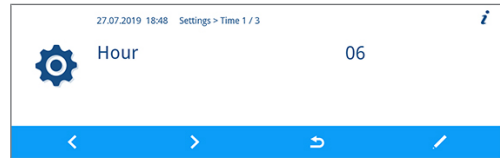

3. Press **FORWARDS/BACK** to change the parameter.

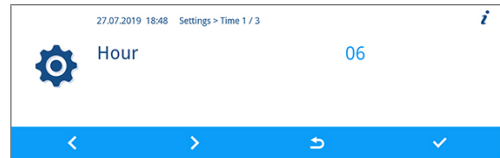

4. Press **CONFIRM** to accept the changes.

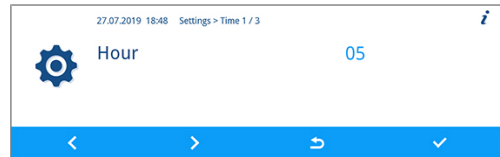

Setting the display brightness

The following must be fulfilled or present:

- ✓ The **Settings > Display brightness** menu is open.

1. Press **EDIT**.

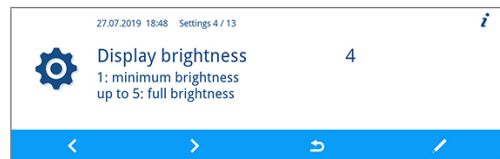

2. Press **FORWARDS/BACK** to change the parameter. The colour bar gives an impression of the colour contrast.

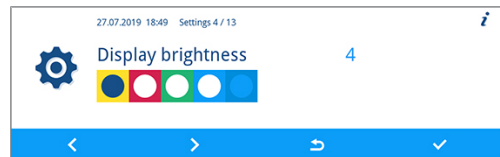

3. Press **CONFIRM** to accept the changes.



Setting the idle mode

The following must be fulfilled or present:

- ✓ The **Settings > Idle mode in min** menu is open.

1. Press **EDIT**.



2. Press **FORWARDS/BACK** to change the parameter.



3. Press **CONFIRM** to accept the changes.



Setting the volume of the signal tone

The following must be fulfilled or present:

- ✓ The **Settings > Signal tone volume** menu is open.

1. Press **EDIT**.



2. Press **FORWARDS/BACK** to change the parameter.



3. Press **CONFIRM** to accept the changes.



Setting the volume of the key tone

The following must be fulfilled or present:

- ✓ The **Settings > Key tone volume** menu is open.

1. Press **EDIT**.



2. Press **FORWARDS/BACK** to change the parameter.



3. Press **CONFIRM** to accept the changes.



Connectivity

In the **Connectivity** submenu, you can connect the device to the MELAconnect app. You can use this app to monitor instrument reprocessing performed on multiple devices in parallel and to access context-related troubleshooting assistance.

Establishing a connection between the MELAG device and the MELAconnect app

The following must be fulfilled or present:

- ✓ The MELAconnect app is installed on your mobile end device (e.g. smartphone, tablet).
- ✓ The device is connected to the (practice) network, see [Setting the network](#) [▶ page 51].
- ✓ The **Settings > Connectivity** menu is open.

1. Press **CONFIRM**.

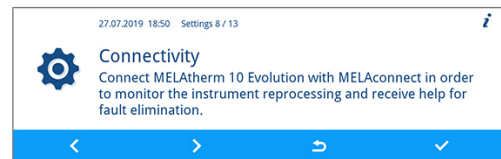

↳ The QR code is displayed in the place of the symbol in the main area of the display.

2. Open the MELAconnect app on your mobile device.
3. Scan the QR code using the MELAconnect app on your mobile end device.

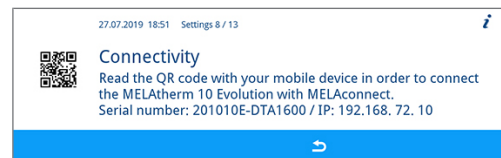

↳ The serial number and the IP address of your device are transmitted to the app.

Alternatively, you can enter the IP address of your device manually in the MELAconnect app. With manual entry of the IP address: Owners of multiple MELAG devices of the identical type can differentiate between their devices by viewing serial number on the display to check whether MELAconnect has been connected to the correct device.

Setting the language

The following must be fulfilled or present:

- ✓ The **Settings > Language** menu is open.

1. Press **EDIT**.

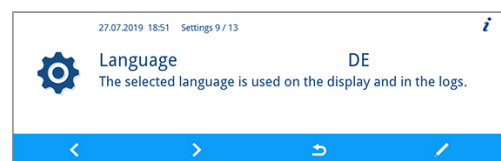

2. Press **FORWARDS/BACK** to change the parameter.

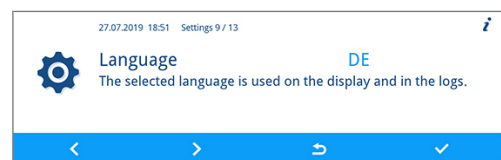

3. Press **CONFIRM** to accept the changes.

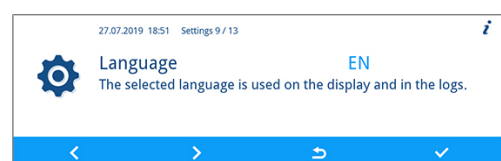

Setting the water supply

If the device is connected to a **DI water** supply e.g. MELAdem 53/MELAdem 53 C or another water treatment unit, this must be set on the device.

When the device is delivered, the water supply has been set to **DI water yes**.



PLEASE NOTE

This setting is performed by the service technician during device commissioning.

The following must be fulfilled or present:

✓ The **Settings > DI water** menu is open.

1. Press **EDIT**.

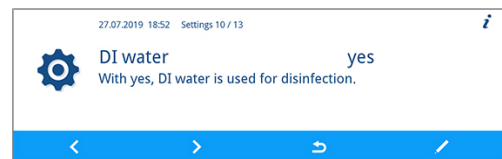

2. Press **FORWARDS/BACK** to change the parameter.

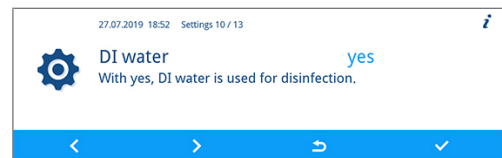

3. Press **CONFIRM** to accept the changes.

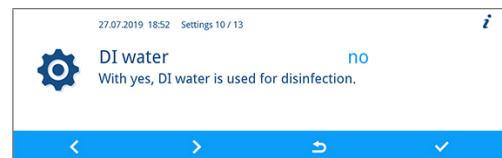

Setting the water hardness



PLEASE NOTE

The service technician determines and sets the water hardness during device commissioning.

The following must be fulfilled or present:

✓ The **Settings > Water hardness in °dH** menu is open.

1. Press **EDIT**.

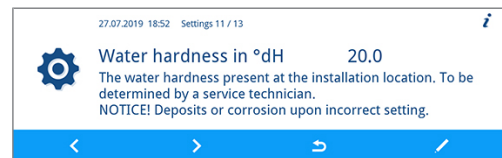

2. Press **FORWARDS/BACK** to change the parameter.

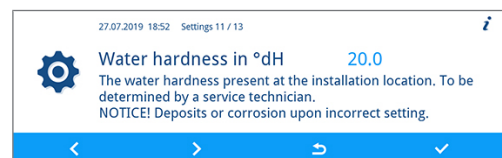

3. Press **CONFIRM** to accept the changes.

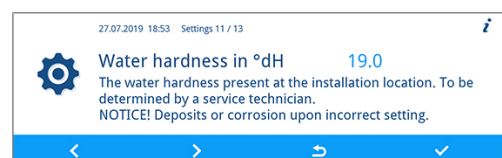

Administrative settings

Working in the **Administration** submenu, the administrator is able to assign user PINs to existing user IDs as well as activate or deactivate the authentication and batch approval.

Logging in as an administrator

The following must be fulfilled or present:

- ✓ The **Settings > Administration** menu is open.

1. Press **CONFIRM**.

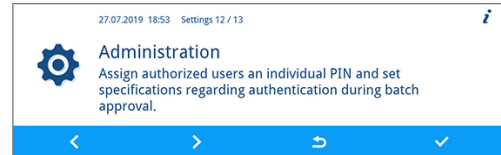

2. Enter the admin PIN (factory-set admin PIN: 1000) and press **CONFIRM**.



➔ Successful login will result in display of the **user** submenu. You are logged in as an administrator.

Logging out as an administrator

The following must be fulfilled or present:

- ✓ You are logged in as an administrator.
- ✓ The **Settings > Administration** menu is open.

1. In any view, press **LEAVE** until the confirmation prompt to exit the settings is displayed.

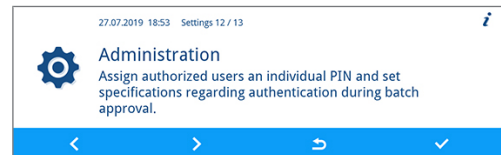

2. Press **YES** to exit the settings.

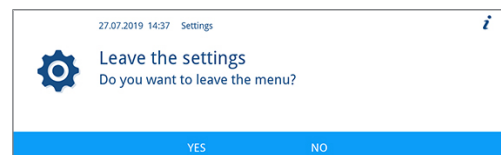

3. Press **YES** or **NO** to save or discard the settings.

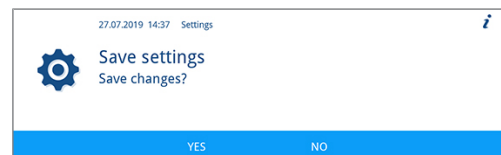

➔ The **settings** menu appears. You are logged out as an administrator.

User

In the **Settings > Administration > User** menu, 20 user IDs are preset. The administrator can assign and edit a user PIN to each user ID. Every user PIN consists of four digits.

Creating and assigning a new user PIN

When the device is delivered, the user IDs 2 to 20 have not been assigned a PIN. The administrator can create a user PIN for each of these IDs. User IDs without a user PIN are marked with a dash.



PLEASE NOTE

The PIN 1000 is reserved for the administrator and cannot be assigned to another user ID. This also applies when the admin PIN has been changed.

The following must be fulfilled or present:

- ✓ You are logged in as an administrator.
 - ✓ The **Settings > Administration > User** menu is open.
1. Press **FORWARDS/BACK** until a user ID (from 2 to 20) is displayed without a four-digit PIN.
 2. Press **EDIT**.
 3. Select four digits from 0 to 9 to create a user PIN.
 4. Press **CONFIRM** to assign the PIN to the displayed user ID.

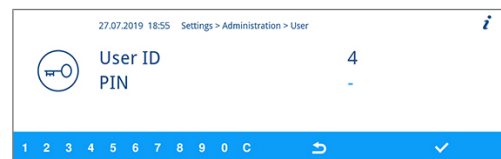
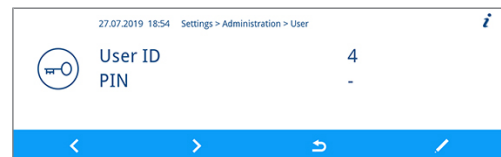

User PIN already assigned

If you want to confirm an already existing user PIN, then the message **"PIN already assigned!"** appears. This PIN is not assigned to the displayed user ID and must be changed.

1. Working in the action bar, press **C** until all the digits to be changed have been deleted.
2. Working in the action bar, select digits from 0 to 9 to change the four-digit PIN.
3. Press **CONFIRM** to assign the altered PIN to the displayed user ID.

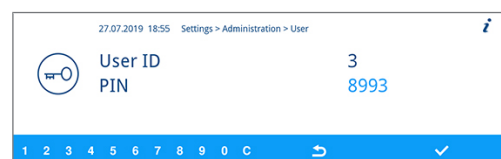
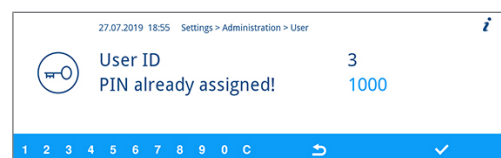

➔ If the user PIN is not already assigned, the colour of the changed PIN changes from light to dark blue.

Changing an existing admin/user PIN

When the device is delivered, the admin PIN is set to 1000 by default. MELAG recommends that you change the admin PIN upon commissioning. The admin PIN (user ID 1) can be changed just as a user ID (user ID 2-20).



PLEASE NOTE

If the changed Admin PIN is lost, contact an authorised service or a stockist technician.

The following must be fulfilled or present:

- ✓ You are logged in as an administrator.
- ✓ The **Settings > Administration > User** menu is open.

1. Press **FORWARDS/BACK** until the user ID is displayed with the PIN to be changed.

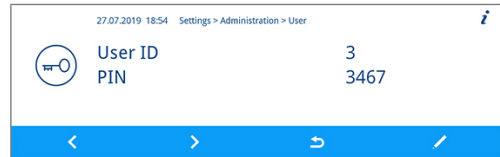

2. Press **EDIT**.

3. Working in the action bar, press **C** until all the digits to be changed have been deleted.

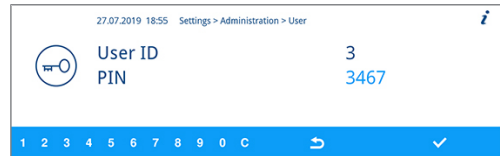

4. Working in the action bar, select digits from 0 to 9 to create the four-digit PIN.

5. Press **CONFIRM** to assign the altered PIN to the displayed user ID.

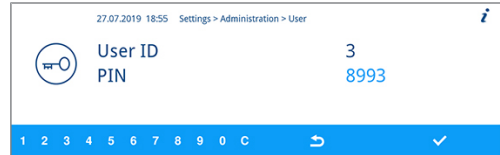

Deleting the user PIN

The following must be fulfilled or present:

- ✓ You are logged in as an administrator.
- ✓ The **Settings > Administration > User** menu is open.

1. Press **FORWARDS/BACK** until the user ID (from 2 to 20) is displayed with the PIN to be deleted.

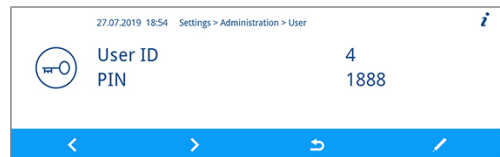

2. Press **EDIT**.

3. Working in the action bar, press **C** repeatedly until all four digits have been deleted and a dash is displayed.



4. Press **CONFIRM** to accept the changes.

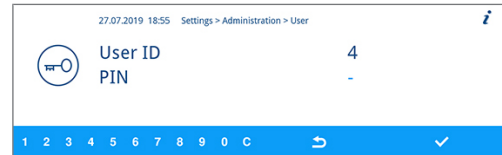

→ The displayed user ID is no longer assigned a user PIN.

Authentication

The administrator can activate or deactivate user authentication. When the device is delivered, authentication is deactivated by default (= **inactive**).

Activating authentication

The following must be fulfilled or present:

- ✓ You are logged in as an administrator.
- ✓ The **Settings > Administration > Authentication** menu is open.

1. Press **EDIT**.

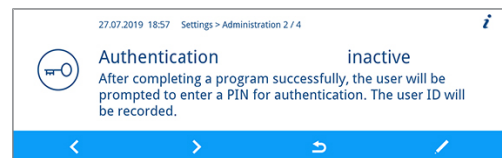

2. Press **FORWARDS**.

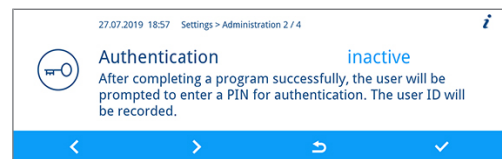

→ The setting changes from **inactive** to **active**.

3. Press **CONFIRM** to accept the changes.

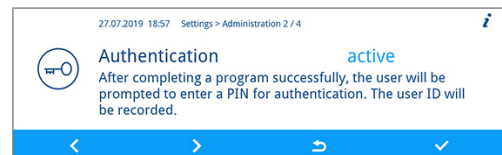

→ Authentication is activated. The log shows **User ID: ##**.

Deactivating authentication

- ▶ Deactivating authentication is done in the same way as activating it.
- The setting changes from **active** to **inactive**.
- The log shows **User ID: DEACTIVATED**.

Batch approval

The administrator can activate or deactivate batch approval. When the device is delivered, batch approval is deactivated by default (= *inactive*).

Activating batch approval

The following must be fulfilled or present:

- ✓ You are logged in as an administrator.
- ✓ The **Settings > Administration > Batch approval** menu is open.

1. Press **EDIT**.

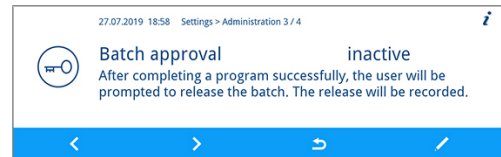

2. Press **FORWARDS**.

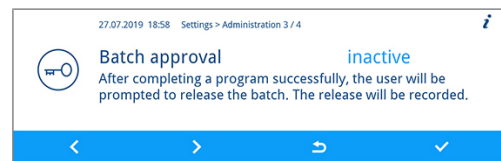

↳ The setting changes from *inactive* to *active*.

3. Press **CONFIRM** to accept the changes.

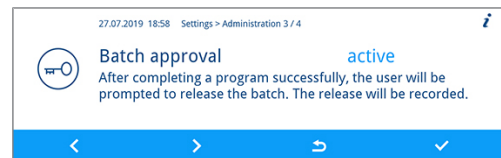

↳ Batch approval is activated. The log shows **Batch approved: YES** or **NO**.

Deactivating batch approval

▶ Deactivating batch approval is done in the same way as activating it.

↳ The setting changes from *active* to *inactive*.

↳ The log shows **Batch approved: DEACTIVATED**.

9 Function tests

Automatic and manual functional check

Automatic

The device components are monitored and checked automatically for their functionality and interplay. Should the parameter thresholds be exceeded, the device will issue warning messages or malfunction messages. If necessary, it will abort a program with the relevant notification. The device will also display messages when a program has been completed.

Manual

You can follow the program run on the display and use the log recorded to check the success of a program. Further information is provided in chapter [Logging](#) [▶ page 41].

Measuring conductivity

You can access the water quality of the ▶DI water on the device display at any time.

1. In the main menu, press **FORWARDS/BACK** until **Conductivity measurement DI** is displayed.

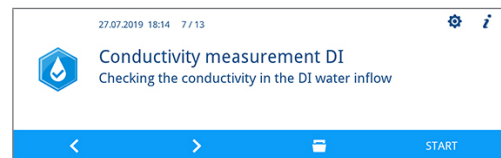

2. Press **START** to start the program.

10 Maintenance

Video tutorial

See also "Regular Checks".



WARNING

All maintenance work, especially that performed in the washing chamber may only be performed after a successfully completed reprocessing program.

- Wear suitable personal protective equipment (e.g. gloves).

Maintenance intervals

Interval	Measure	Device component
Daily	Check for soiling, deposits or damage	Coarse and fine sieves, rinse arms, door seal
Monthly	Check for passage/blockage	Injector rail nozzles and adapters
	Check for soiling, deposits or damage	Accessories, plastic components
As required	Cleaning	Operating panel, plastic front, washing chamber, pump sump and non-return valve
After 24 months or 1000 cycles	Maintenance	Process agent hoses By the authorised customer services working in accordance with the maintenance instructions

Regular checks and cleaning



NOTICE

Incorrect cleaning can damage the surfaces and sealing faces. Scratched or damaged surfaces and leaking sealing faces favour soiling deposits and corrosion in the washing chamber.

- Comply with all information regarding cleaning of the parts affected.



NOTICE

When the coarse and fine sieves are missing, residue may enter the rinsing circuit and impair the device function.

- Ensure that the coarse and fine sieves are always in place before program start.

Checking the sieves in the washing chamber

A coarse and a fine sieves are fitted in the washing chamber. The sieves are designed to hold back dirt particles or residue e.g. from the instruments. They can become blocked over time.

1. Inspect the coarse and the fine sieves for small components and soiling which have fallen from the load.

2. Turn the grip of the coarse sieve anti-clockwise to its fullest extent and remove it upwards.

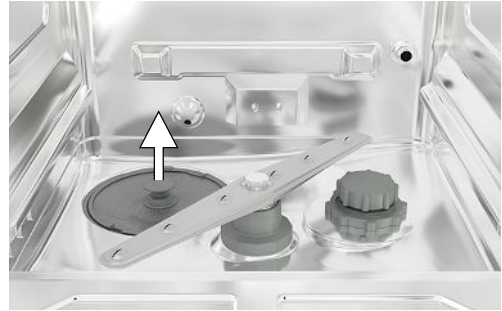

3. Turn the knurled nut on the fine sieve anti-clockwise and remove the fine sieve upwards.

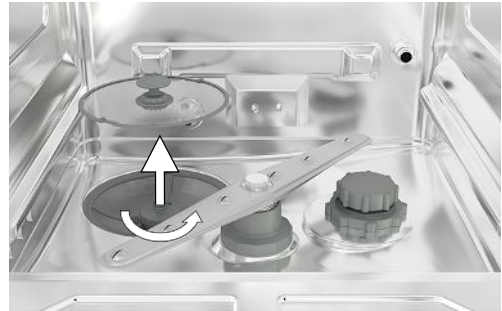

4. Inspect the coarse and the fine sieves for soiling.
5. Rinse the soiled sieves under running water. Do not use any dish-washing detergent. Remove any deposits with a soft brush.

Checking the rinse arms

Dirt particles can block the nozzles of the rinse arms. Check both rinse arms regularly and rinse the nozzles under running water if necessary.

1. Check that the coarse and the fine sieves are installed.
2. Turn the knurled nut on the rinse arm anti-clockwise and remove the rinse arm.

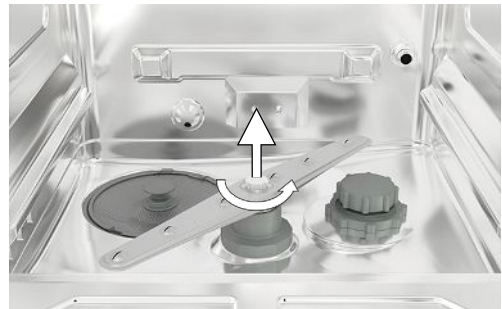

3. Clean blocked nozzles with a thin pointed object.

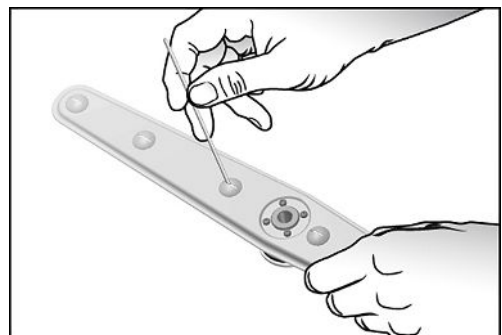

4. Return the rinse arms and check their easy and free movement.

Checking the door seal

Check the door seal for impurities, deposits or damage on a daily basis. If necessary, clean the door seal with a moist, non-fuzzing cloth and conventionally-available neutral liquid cleaning agent.

Checking the injector rail nozzles and adapters for free passage

MELAG recommends checking the injector rail nozzles and adapters for free passage on a monthly basis.

To test whether the injector rail nozzles and adapters are blocked, hold them upright under running water. If the water flows freely through the nozzles or adapters, they are not blocked.

Checking the accessories

Check the accessories used (especially their plastic components e.g. inserts) for damage, deposits and soiling on a monthly basis, unless the user manual Accessories for MELAtherm indicates otherwise.

Cleaning on demand

Operating unit and plastic front

Note the following:

- Use a soft, non-fuzzing cloth.
- Use a chlorine- and vinegar-free cleaning fluid or a plastics cleaning agent.
- Check the material compatibility before application.
- Never use solvents or benzene.
- Use surface disinfectants which are suitable for plastics. Observe the manufacturer's information on the respective surface disinfectant.

Washing chamber

Note the following:

- The washing chamber is made of high-alloy stainless steel but its surface is easily scratched.
- Clean it with a commercially-available non-abrasive stainless steel cleaning agent (no scouring cream).
- Remove any streaks remaining on the surface after cleaning with a commercially-available stainless steel polishing spray.
- Use a soft, non-fuzzing cloth without abrasive elements (no scouring pad).

Pump sump and non-return valve

If the rinsing water has not been removed entirely after a program, the non-return valve must be cleaned.

1. Remove the coarse and fine sieves and remove the residue and deposits from the pump sump.
2. Remove the non-return valve upwards by pulling on its grip and pull it out of the pump sump.

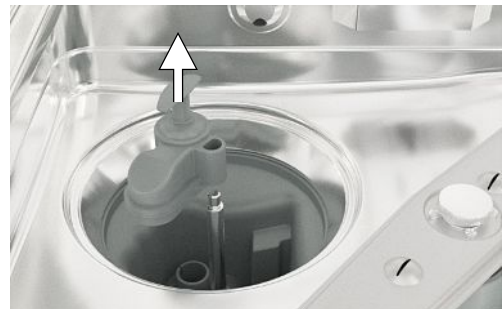

3. Clean the non-return valve under running water. Do not use any dish-washing detergent.
4. Replace the non-return valve and the fine and coarse sieves in the pump sump.
5. Start the "Rinsing" program.

Avoiding staining

Stains on the instruments or the device can develop from poor water quality. In particular, heavy metals or chloride can result in the development of stains and/or corrosion. To avoid the development of stains and/or corrosion on the instruments or the washing chamber, MELAG recommends a final rinse with demineralised water (DI water). All water-bearing parts of the device consist of non-rusting material. This rules out the development of stains or rust caused by the device. Often, a single instrument which drops rust can suffice to cause the development of rust on other instruments or in the device. Further information is provided in the up-to-date Red Brochure "Instrument Reprocessing - Reprocessing of Instruments to Retain Value" published by the AKI. See chapter "Surface Changes: Deposits, Discoloration, Corrosion, Aging, Swelling and Stress Cracks".

Replacing the filter in the drying fan

Exceeding the permissible level of blockage can result in a worsened drying outcome. For this reason, the device checks the degree of blockage automatically. Exceeding the tolerances results in the issue of the relevant display message.



PLEASE NOTE

The pre-filter and the HEPA filter are replaced within the scope of the maintenance on hygienic grounds.

1. Pull the process agent drawer forwards.



2. Undo the screw on the cover cap (pos. a) of the drying fan by hand and lift up the cover cap.

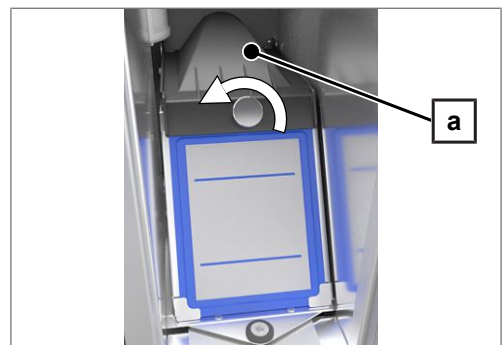

3. Pull out the pre-filter (pos. c) upwards and replace it. Pull out the HEPA filter (pos. b) upwards and replace it.

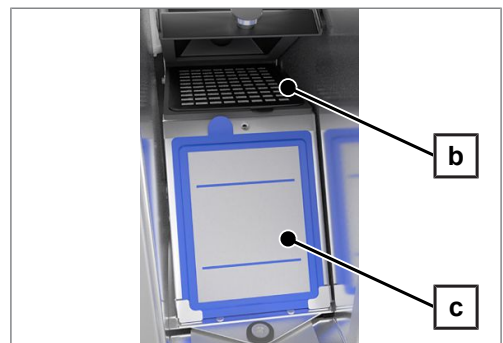

4. Close the cover cap and turn the screw hand-tight.

Maintenance



NOTICE

Continuing operation beyond the maintenance interval can result in malfunctions in the device.

- Maintenance should only be performed by trained and authorised service technicians or stockist technicians.
 - Maintain the specified servicing intervals.
-

Regular maintenance is vital to ensure reliable operation and value retention of the device. All function and safety-relevant components and electrical units are checked during maintenance and replaced where necessary. The maintenance is performed by an authorised customer services/stockist technician working in accordance with the maintenance instructions. A freely-accessible device has a maintenance time of approx. 3 h plus test run and any work exceeding the specifications of the regular maintenance plan.

The maintenance is to be performed regularly after 1000 cycles or at the latest 24 months.

(Process) Validation

A reproducible cleaning and disinfection outcome can only be ensured via correct operation (incl. use of suitable accessories). The practice operator is responsible for ensuring reproducibility through the use of batch checks, routine checks and/or periodic inspections (e.g. validation).

This requirement is made (in Germany) by e.g. the Medical Devices Operating Directive (§ 8 Sec. 2 MPBetreibV); ▶[DGKH](#), ▶[DGSV](#) and ▶[AKI](#) directives and the recommendations from the ▶[Robert Koch Institute](#). This requirement is also made in international regulations. This is based on ▶[EN ISO 15883](#), which is also valid in Germany. Please observe all valid national regulations and specifications. In case of doubt, consult the relevant professional association.

- Only use the loading pattern specified and approved within the scope of the validation. Changing the loading pattern and/or accessories requires revalidation.
- The use of ▶[process agents](#) that are not recommended by MELAG (see [Process agents](#) [▶ page 10]) may cause an increased effort for validation / performance requalification.
- MELAG cannot provide a guarantee for non-MELAG accessories, even if they are in possession of validation.
- The document "Recommendations for the validation of MELAtherm 10 Evolution" (doc. ME_007-22) is available for download in the MELAG service portal for the person performing the validation and the technical service.

11 Pause times

Video tutorial

See also "Pause Times".



Run the "Rinsing" program twice before reprocessing following pause times longer than two days (e.g. after a weekend). Given an ophthalmic application, run the Ophthalgo-Program without load following pause times of more than two days in order to obtain the requisite water quality.

Long operating pauses (longer than two weeks)

- Decommission the device if you plan to have an immobilisation time of over two weeks.

Decommissioning

Preparation for transport

Decommissioning in preparation for transport outside the practice should only be undertaken by MELAG-authorized persons.

Following longer operating pauses

When decommissioning the device for a long pause (e.g. due to holiday), proceed as described in the following.

The following must be fulfilled or present:

- ✓ The washing chamber is dry.
- 1. Switch off the device at the power switch.
- 2. Disconnect the power plug from the socket.
- 3. Turn off the water inflow.

Recommissioning



NOTICE

Air must be removed from the metering system during commissioning or after removal of the suction lances. Air removal completely removes air bubbles from the hoses and ensures proper metering.

- Before the first reprocessing program, run the "Air removal" program.
- Then start your usual reprocessing program without a load.

- ▶ Comply with the specifications in chapter [First steps](#) [▶ page 20] when performing the recommissioning.

Transport within the practice



CAUTION

Danger of injury from incorrect carrying.

Lifting and carrying too heavy a load can result in spinal injury. Failure to comply with these provisions can result in crushing.

- Comply with the safety regulations issued by your professional association.
-

Note the following:

- Empty the device entirely.
- Remove the inserts and the basis basket.
- Seal the water inlet hoses.
- Close the door before moving the device.
- Avoid strong shocks/vibrations.

Frost protection

Operate the device in a generally frost-free environment. Should any residual fluids freeze in the device, the device should be held at room temperature for a minimum of two hours so that they can thaw.

Recommissioning after relocation

When recommissioning after a move, proceed as with the first commissioning, see [First steps](#) [▶ page 20].

12 Malfunctions

Troubleshooting online

All messages with current descriptions can be found in the Troubleshooting portal on the MELAG website (<https://www.melag.com/en/service/troubleshooting>).



Not all messages on the display are malfunction messages. Messages are issued on the display with an event number. This number is used for identification for assistance on the MELAG website, the MELAconnect app and with the authorised customer service or stockist technician.

Notification

A notification is provided for your information and to assist you in operating the device. Malfunction-free operation of the device is still possible.

▶ Example:

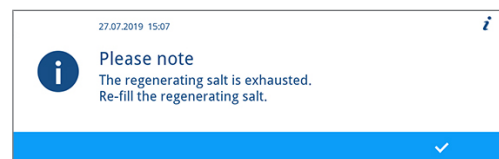

Warning message

A warning message helps to ensure malfunction-free operation and recognition of undesirable situations. React to a warning message quickly to prevent the resulting malfunction.

▶ Example:

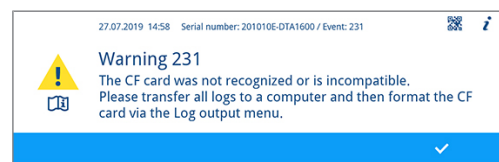

Malfunction message

Malfunction messages are issued when it is not possible to ensure safe operation or cleaning and disinfection. These can appear on the display shortly after switching on the device or while a program is running. If a malfunction occurs during a program run, the program will be aborted and considered unsuccessful.

▶ Example:

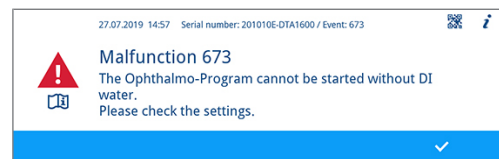

WARNING

Danger of contamination through program abort!

Aborting a program before the drying phase begins means that the load is classed as not having been disinfected. This endangers the health of the patient and the practice team.

Displaying events in MELAconnect

You can use the MELAconnect app to access the information you need to remedy a malfunction. A QR code is displayed in the context menu following warning and malfunction messages.

Transmitting event data

The following must be fulfilled or present:

- ✓ The MELAG device is connected to the MELAconnect app, see [Connectivity](#) [▶ page 57].

1. In the context menu, press **QR-CODE**.

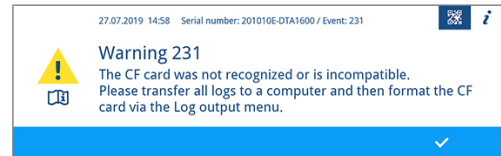

2. Open the MELAconnect app on your mobile end device and select the **Troubleshooting** menu.

3. Scan the QR code on the display of the MELAtherm (to the left of the event text).

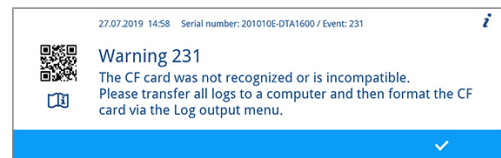

→ The serial number of the device and the event number are transmitted to the MELAconnect app and context-related information on the cause and remedy is displayed.

Alternatively, you can enter the displayed event number directly in the MELAconnect app and search for it.

For devices that are already monitored, the MELAconnect app provides a link for further information directly in the displayed warning or malfunction message.

Notifications, warning and malfunction messages

The following tables indicate possible causes for certain events and the corresponding operating information for their remedy. Should you be unable to find the relevant event, or your efforts do not redress the problem, you can contact your nearest stockist or authorised MELAG customer service provider. Please have the serial number of your device, the event number and a detailed description of the message ready.

Notifications

Event	Possible cause	Remedy
Banging or rattling noise in the washing chamber during a program run	The rinse arm bangs against instruments or containers. The load moves in the washing chamber.	<ol style="list-style-type: none"> 1. Interrupt the program and re-arrange the load. 2. Start the program again.
White layer on the instruments	The internal water softening unit has not been adjusted correctly.	Check the water hardness of the tap water and re-adjust the internal water softening unit if necessary, see Description of the device [▶ page 11].
	Water-insoluble, hardened treatment residue (e.g. dental cement or root canal disinfectants) remain on the instruments.	Remove the residue manually immediately after instrument application.
	Residues or precipitates of ultrasound gel may have remained on the instruments.	Avoid cleaning agents and disinfectants based on quaternary ammonium compounds in the manual pre-cleaning of lubricant gel residues. Gels containing thickening agents, especially polyacrylic acid, will precipitate after contact with quaternary ammonium compounds. If a change of gel is preferred, then devices with a cation-compatible thickening system are suitable. Contact the manufacturer of the gel or process agents for more information.
Poor cleaning outcome	The basis basket, insert baskets / insert racks are incorrectly loaded or are too full.	Ensure correct arrangement and avoid overloading.
	Load results in unwashed areas.	Ensure the correct arrangement of the instruments.
	The cleaning agent is unsuitable for this type of soiling.	Use a suitable cleaning agent for automatic cleaning.
	Encrusted soiling on the instruments.	Do not allow soiling to dry on. Rinse off soiling immediately.
	Rinse arm nozzles or injector rail nozzles blocked.	Remove blockages, see Maintenance [▶ page 65].
	Sieves in the pump sump are soiled.	Clean the coarse and the fine sieve, see Maintenance [▶ page 65].
Empty display	The device is not switched on.	Check that the device is connected to the power supply and is switched on.
	The fuse in domestic installation has tripped. This can be caused by operating a number of electrical devices at the same time.	Check the fuse in the domestic installation (for the minimum fuse protection, see the type plate).
Residual moisture on and/or in the instruments	The basis basket, insert baskets / insert racks are incorrectly loaded or are too full.	Ensure correct arrangement and avoid overloading.
	The interior structure of the instruments is too complex or the interior volume is insufficient.	Dry the instruments with clean (medical) compressed air.
Display message: The regenerating salt is exhausted. Re-fill the regenerating salt.	The regenerating salt is exhausted.	Fill the salt container with regenerating salt. The signal (a tone) informs the operator that the salt in the salt container has been recognised and that operation can be continued.

Warning messages

Event	Possible cause	Remedy
214	The CF card was removed from the slot during a running program and re-inserted.	Once the program has been completed, working in the display, select the Log output and output the current log. Do not remove the CF card during active logging. Logging is active when the red LED illuminates.
215 216 217	The CF card is not functioning correctly. The system does not recognise a CF card or cannot read it.	1. Save the logs on an external data carrier. 2. Select the Log output menu on the display and navigate to CF card formatting . Format the CF card in the device, see the technical manual.
	The memory of the CF card is too large (max. 4 GB).	Insert a CF card with a memory of up to 4 GB. During insertion, the MELAG lettering must point to the right. MELAG recommends the use of original accessories only.
218	While reading out the logs via the Log output menu, an existing log was detected on the CF card.	Press CONFIRM to acknowledge the message. The existing log is not overwritten.
219 220	The CF card is not functioning correctly. The system does not recognise a CF card or cannot read it.	1. Save the logs on an external data carrier. 2. Select the Log output menu on the display and navigate to CF card formatting . Format the CF card in the device, see the technical manual.
	The memory of the CF card is too large (max. 4 GB).	Insert a CF card with a memory of up to 4 GB. During insertion, the MELAG lettering must point to the right. MELAG recommends the use of original accessories only.
221	The memory space of the CF card is full. No further logs can be saved.	1. Save the logs on an external data carrier. 2. Select the Log output menu on the display and navigate to CF card formatting . Format the CF card in the device, see the technical manual.
222 223 224 225	The CF card is not functioning correctly. The system does not recognise a CF card or cannot read it.	1. Save the logs on an external data carrier. 2. Select the Log output menu on the display and navigate to CF card formatting . Format the CF card in the device, see the technical manual.
226 227	The memory of the CF card is too large (max. 4 GB).	Insert a CF card with a memory of up to 4 GB. During insertion, the MELAG lettering must point to the right. MELAG recommends the use of original accessories only.
228	The CF card is too slow. Either the CF card is no longer recognised following a reset or it was inserted in the slot under voltage.	1. Save the logs on an external data carrier. 2. Insert a new CF card (max. 4 GB) in the card slot. During insertion, the MELAG lettering must point to the right. MELAG recommends using original accessories only.
229	The CF card was removed from the slot during a writing action.	If the program has been concluded, working in the display, select the Log output menu and output the current log. Do not remove the CF card during active logging. Logging is active when the red LED illuminates.

Event	Possible cause	Remedy
230	The CF card is not functioning correctly. The system does not recognise a CF card or cannot read it.	<ol style="list-style-type: none"> 1. Save the logs on an external data carrier. 2. Select the Log output menu on the display and navigate to CF card formatting. Format the CF card in the device, see the technical manual.
	The memory of the CF card is too large (max. 4 GB).	<p>Insert a CF card with a memory of up to 4 GB. During insertion, the MELAG lettering must point to the right.</p> <p>MELAG recommends the use of original accessories only.</p>
231	The CF card is not functioning correctly. There is no CF card in the slot.	<p>Insert a CF card with a memory of up to 4 GB. During insertion, the MELAG lettering must point to the right.</p> <p>MELAG recommends using original accessories only.</p>
	The system does not recognise a CF card or cannot read it.	Push the CF card in the card slot until the ejector key triggers.
232	The CF card is not functioning correctly.	Press CONFIRM to acknowledge the message.
233	The CF card is currently being initialised or written.	
234 235 236 237	The CF card is not functioning correctly. The system does not recognise a CF card or cannot read it.	<ol style="list-style-type: none"> 1. Save the logs on an external data carrier. 2. Select the Log output menu on the display and navigate to CF card formatting. Format the CF card in the device, see the technical manual.
	The memory of the CF card is too large (max. 4 GB).	<p>Insert a CF card with a memory of up to 4 GB. During insertion, the MELAG lettering must point to the right.</p> <p>MELAG recommends the use of original accessories only.</p>
238	The CF card is not functioning correctly and cannot be formatted.	<p>Insert a new CF card (max. 4 GB) in the card slot. During insertion, the MELAG lettering must point to the right.</p> <p>MELAG recommends using original accessories only.</p>
239 240	The CF card is not functioning correctly. The system does not recognise a CF card or cannot read it.	<ol style="list-style-type: none"> 1. Save the logs on an external data carrier. 2. Select the Log output menu on the display and navigate to CF card formatting. Format the CF card in the device, see the technical manual.
	The memory of the CF card is too large (max. 4 GB).	<p>Insert a CF card with a memory of up to 4 GB. During insertion, the MELAG lettering must point to the right.</p> <p>MELAG recommends the use of original accessories only.</p>
372	The internal log memory of the device is full. Not all logs have been outputted.	<ol style="list-style-type: none"> 1. Working in the display, select the Log output menu and output the logs of the internal memory. 2. Start the program again. 3. If this message is displayed repeatedly, delete the internal memory.

Event	Possible cause	Remedy
377	The system does not recognise an output medium. The system does not recognise a log printer, even though it is connected.	Check the settings in the Settings > Log settings menu.
	Working in the Settings > Log settings menu, at least one output is active and Immediate output has been set to yes . However, a log printer is not connected.	<ol style="list-style-type: none"> Working in the display, select the Log output menu and save the log on the CF card or the computer. Open the Settings > Log settings menu and deactivate Immediate output. The display changes from yes to no.
386	There are logs in the internal log memory of the device that have not yet been output. The memory is almost full.	<ol style="list-style-type: none"> Press CONFIRM to acknowledge the message. The program starts. As soon as the program is finished, select the Log output menu on the display and output all logs of the internal memory (CF card or external data carrier).
394	Not all logs from the internal device memory are stored on the CF card yet.	Press CONFIRM to acknowledge the message. The logs are written to the CF card and saved.
395	Not all logs from the internal log memory of the device have been output via the EDM printer.	Press CONFIRM to acknowledge the message. The logs are output and printed.
396	Not all logs have been loaded from the internal log memory of the device to the FTP server.	Press CONFIRM to acknowledge the message. The logs are output and saved.
397	The system is unable to locate a computer for log output. Even though the device is connected to a computer, it is unable to establish a connection for log output.	<ol style="list-style-type: none"> Check the network connection to the computer/server. Switch on the computer/server. Restart the documentation software.
	The device is not connected to a computer, but in the Settings > Log settings menu, the Computer parameter is set to yes (active).	Select the Settings > Log settings menu on the display and deactivate the Computer parameter. The display changes from yes to no .
414	The rinse aid has been exhausted.	<ol style="list-style-type: none"> Replace the rinse aid container, working in accordance with the working safety regulations. Alternatively, refill. Start the "Air removal" program. <p>NOTICE! Use only process agents which you have used before.</p>
424	The neutraliser has been exhausted.	<ol style="list-style-type: none"> Replace the neutraliser container, working in accordance with the working safety regulations. Alternatively, refill. Start the "Air removal" program. <p>NOTICE! Use only process agents which you have used before.</p>
425	The cleaning agent has been exhausted.	<ol style="list-style-type: none"> Replace the cleaning agent container, working in accordance with the working safety regulations. Alternatively, refill. Start the "Air removal" program. <p>NOTICE! Use only process agents which you have used before.</p>
428	There is almost no regenerating salt left.	Fill regenerating salt, see Filling the regenerating salt [▶ page 23].
447	The rinse pressure in the washing chamber is too low. Large containers with the opening pointing upwards may have been sorted into the device. This diverts water from the rinsing process.	Sort the containers in the device with their openings facing downwards.

Event	Possible cause	Remedy
450	The water inflow is insufficient.	Check the water supply of the device. Open the water inflow tap completely.
500	The display of the date and time of the system clock are incorrect.	Working in the display, select the Settings menu and set the date and time correctly, see Setting the date and time [▶ page 54].
501	The CF card is not functioning correctly. There is no CF card in the slot.	Insert a CF card with a memory of up to 4 GB. During insertion, the MELAG lettering must point to the right. MELAG recommends using original accessories only.
	The system does not recognise a CF card or cannot read it.	Push the CF card in the card slot until the ejector button triggers.
502	The system is unable to locate a computer for log output. The network connection has been interrupted.	Check the network connection to the computer / server.
	The computer / server is not switched on.	Switch on the computer / server.
	The documentation software has not been started.	Restart the documentation software.
	A computer has not been connected, but in the Settings > Log settings menu, the Computer parameter is set to yes (active).	Working in the display, select the Settings > Log settings menu and deactivate the Computer parameter. The display changes from yes to no .
533	The temperature in the washing chamber is very high. The door is blocked and cannot be unlocked immediately.	CAUTION! The instruments are hot! PLEASE NOTE: Take appropriate safety measures, e.g. keep a safe distance and wear heat-resistant gloves, before opening the device. Press YES to acknowledge the message. The door can be opened.
534	The temperature in the washing chamber is very high. The door is blocked and cannot be unlocked immediately.	CAUTION! Danger of scalding! The instruments are hot. 1. Wait until the temperature in the washing chamber falls below the hazardous temperature. 2. Press CONFIRM in the action bar on the display.
549	The conductivity of the DI water is insufficient (greater than 15 µS/cm). The MELAdem 53/53 C cartridge is exhausted.	Replace the MELAdem 53/53 C cartridge.
	The DI water supply is of insufficient quality.	Check the DI water supply.
560	The maximum permissible mains voltage (270 V) has been exceeded.	Have the connection conditions checked by a qualified electrician.
561	The minimum permissible mains voltage (190 V) was undercut.	Have the connection conditions checked by a qualified electrician.
562	The maximum permissible mains frequency (63 Hz) was exceeded.	Have the connection conditions checked by a qualified electrician.
563	The minimum permissible mains frequency (45 Hz) was undercut.	Have the connection conditions checked by a qualified electrician.
575	The date and time are invalid.	Check the settings in the Settings menu.
622	The maximum permissible maintenance period (24 months) or the maximum permissible number of cycles (1000 cycles) has been reached since commissioning or the last maintenance.	Arrange for maintenance with an authorised customer services or a stockist technician. You can continue to start the device.
625	The temperature during pre-cleaning is too high. The temperature during the water inflow is higher than 45 °C.	Check the water supply to the device.

Event	Possible cause	Remedy
671	<p>Insufficient conductivity (> 15 µS/cm and < 25 µS/cm) was measured in the washing chamber during disinfection in the Ophthalgo-Program.</p> <p>This could be caused by carry-over of process agents, regenerating salt or deposits. The program successfully completed despite the warning.</p>	<ol style="list-style-type: none"> 1. Close the screw cap of the salt container correctly. 2. Setup the containers in the device with their openings facing downwards. 3. Check the hollow bodies before reprocessing for their free passage and correct position. 4. Clean the filter screen in the instrument connection equipment. 5. Remove and clean the coarse and fine sieves, see Regular checks and cleaning [▶ page 65]. 6. Insert the non-return valve in the pump sump correctly, see Cleaning on demand [▶ page 67]. 7. Check for foreign bodies in the non-return valve.

Malfunction messages

Event	Possible cause	Remedy
137	The cleaning agent metering pump is not functioning correctly. The metering system may be blocked.	<ol style="list-style-type: none"> 1. Switch the device off and then on again. 2. Start the program again.
139	The fan of the display is not functioning correctly.	<ol style="list-style-type: none"> 1. Switch the device off and then on again. 2. Start the program again.
140	The fan of the diffuser is not functioning correctly.	<ol style="list-style-type: none"> 1. Switch the device off and then on again. 2. Start the program again.
141	The neutraliser metering pump is not functioning correctly. The metering system may be blocked.	<ol style="list-style-type: none"> 1. Switch the device off and then on again. 2. Start the program again.
142	The rinse aid metering pump is not functioning correctly. The metering system may be blocked.	<ol style="list-style-type: none"> 1. Switch the device off and then on again. 2. Start the program again.
143	The solenoid valve for the cold water does not switch.	<ol style="list-style-type: none"> 1. Switch the device off and then on again. 2. Start the program again.
144	The solenoid valve for the regeneration does not switch.	<ol style="list-style-type: none"> 1. Switch the device off and then on again. 2. Start the program again.
145	The solenoid valve for the steam condenser does not switch.	<ol style="list-style-type: none"> 1. Switch the device off and then on again. 2. Start the program again.
146	The solenoid valve of the DI inlet hose does not switch.	<ol style="list-style-type: none"> 1. Switch the device off and then on again. 2. Start the program again.
147	The solenoid valve of the cold water inlet hose does not switch.	<ol style="list-style-type: none"> 1. Switch the device off and then on again. 2. Start the program again.
154 155	The temperature difference between the two temperature sensors (temperature control and temperature log) in the washing chamber is too high.	<ol style="list-style-type: none"> 1. Switch off the device and wait approx. 30 min with the door open. 2. Switch on the device and restart the program.
156	The temperature sensor for monitoring the drying is not functioning correctly.	<ol style="list-style-type: none"> 1. Switch off the device and wait approx. 30 min with the door open. 2. Switch on the device and restart the program.
159	The collection tank has not been emptied correctly.	<ol style="list-style-type: none"> 1. Switch the device off and then on again. 2. Start the program again.
160	The coarse or fine sieves are soiled.	<ol style="list-style-type: none"> 1. Switch off the device. 2. Clean the coarse and fine sieves, see Regular checks and cleaning [▶ page 65]. 3. Switch on the device and restart the program.

Event	Possible cause	Remedy
161	The washing chamber pressure required for drying has not been reached.	<ol style="list-style-type: none"> 1. Switch the device off and then on again. 2. Start the program again.
162	The requisite rinse pressure has not been reached.	<ol style="list-style-type: none"> 1. Switch the device off and then on again. 2. Start the program again.
163	The cleaning agent metering pump is not functioning correctly. The metering system may be blocked.	<ol style="list-style-type: none"> 1. Switch the device off and then on again. 2. Start the program again.
165	The fan of the display is not functioning correctly.	<ol style="list-style-type: none"> 1. Switch the device off and then on again. 2. Start the program again.
166	The fan of the diffuser is not functioning correctly.	<ol style="list-style-type: none"> 1. Switch the device off and then on again. 2. Start the program again.
167	The neutraliser metering pump is not functioning correctly. The metering system may be blocked.	<ol style="list-style-type: none"> 1. Switch the device off and then on again. 2. Start the program again.
168	The rinse aid metering pump is not functioning correctly. The metering system may be blocked.	<ol style="list-style-type: none"> 1. Switch the device off and then on again. 2. Start the program again.
169	The solenoid valve for the cold water does not switch.	<ol style="list-style-type: none"> 1. Switch the device off and then on again. 2. Start the program again.
170	The solenoid valve for the regeneration does not switch.	<ol style="list-style-type: none"> 1. Switch the device off and then on again. 2. Start the program again.
171	The solenoid valve for the steam condenser does not switch.	<ol style="list-style-type: none"> 1. Switch the device off and then on again. 2. Start the program again.
172	The solenoid valve of the DI inlet hose does not switch.	<ol style="list-style-type: none"> 1. Switch the device off and then on again. 2. Start the program again.
173	The solenoid valve of the cold water inlet hose does not switch.	<ol style="list-style-type: none"> 1. Switch the device off and then on again. 2. Start the program again.
257	The connection to the conductivity sensor has been interrupted. No or an incorrect conductivity measurement is stated.	<ol style="list-style-type: none"> 1. Switch the device off and then on again. 2. Start the program again.
410	The rinse aid has been exhausted.	<ol style="list-style-type: none"> 1. Replace the rinse aid container, working in accordance with the working safety regulations. Alternatively, refill. NOTICE! Use only process agents which you have used before. 2. Start the "Air removal" program.
411	The neutraliser has been exhausted.	<ol style="list-style-type: none"> 1. Replace the neutraliser container, working in accordance with the working safety regulations. Alternatively, refill. NOTICE! Use only process agents which you have used before. 2. Start the "Air removal" program.
412	The cleaning agent has been exhausted.	<ol style="list-style-type: none"> 1. Replace the cleaning agent container, working in accordance with the working safety regulations. Alternatively, refill. NOTICE! Use only process agents which you have used before. 2. Start the "Air removal" program.

Event	Possible cause	Remedy
426	No cleaning agent is being pumped. The cleaning agent container has been exhausted, air may have been transported.	1. Replace the cleaning agent container, working in accordance with the working safety regulations. Alternatively, refill. NOTICE! Use only previously used process agents! 2. Start the "Air removal" program.
	The hose to the suction lance is kinked.	1. Eliminate any kinks or pinch points on the process agent hoses. 2. Start the "Air removal" program.
	Air bubbles have developed in the metering system after long standstill times.	Start the "Air removal" program.
427	No neutraliser is being pumped. The neutraliser container has been exhausted, air may have been transported.	1. Replace the neutraliser container, working in accordance with the working safety regulations. Alternatively, refill. NOTICE! Use only previously used process agents! 2. Start the "Air removal" program.
	The hose to the suction lance is kinked.	1. Eliminate any kinks or pinch points on the process agent hoses. 2. Start the "Air removal" program.
	Air bubbles have developed in the metering system after long standstill times.	Start the "Air removal" program.
431	No cleaning agent is being pumped. The cleaning agent container is empty or almost empty.	1. Replace the cleaning agent container, working in accordance with the working safety regulations. Alternatively, refill. NOTICE! Use only previously used process agents! 2. Start the "Air removal" program.
	The hose to the suction lance is kinked.	1. Eliminate any kinks or pinch points on the process agent hoses. 2. Start the "Air removal" program.
	Air bubbles have developed in the metering system after long standstill times.	Start the "Air removal" program.
432	No neutraliser is being pumped. The neutraliser container is empty or almost empty.	1. Replace the neutraliser container, working in accordance with the working safety regulations. Alternatively, refill. NOTICE! Use only process agents which you have used before. 2. Start the "Air removal" program.
	The hose to the suction lance is kinked.	1. Eliminate any kinks or pinch points on the process agent hoses. 2. Start the "Air removal" program.
	Air bubbles have developed in the metering system after long immobilization times.	Start the "Air removal" program.
433	Water is in the pump sump after pumping out. The coarse or fine sieve is soiled.	Clean the coarse and fine sieves, see Regular checks and cleaning [▶ page 65].
	The non-return valve in the pump sump is missing or fitted incorrectly.	Insert the non-return valve in the pump sump correctly, see Regular checks and cleaning [▶ page 65].
	The non-return valve is blocked by a foreign body.	Check the non-return valve for foreign bodies and remove them if you find any.

Event	Possible cause	Remedy
434	Water is in the pump sump after pumping out. The coarse or fine sieve is soiled.	Clean the coarse and fine sieves, see Regular checks and cleaning [▶ page 65].
	The non-return valve in the pump sump is missing or fitted incorrectly.	Insert the non-return valve in the pump sump correctly, see Regular checks and cleaning [▶ page 65].
	The non-return valve is blocked by a foreign body.	Check the non-return valve for foreign bodies and remove them if you find any.
	The outlet hose is kinked.	Check the installation of the outlet hose.
	The siphon or outlet hose is blocked.	Check the siphon and the outlet hose for blockage.
440	The current program has been terminated prematurely. The load is classed as not cleaned and disinfected.	Press CONFIRM to acknowledge the message.
449	The rinse pressure in the washing chamber is too low. Insufficient water inflow.	Check the water inflow of the device. Open the water inflow tap completely.
	The basis basket has been inserted incorrectly or not at all.	Insert the basis basket in the washing chamber correctly, see Inserting the basis basket [▶ page 23].
	Too many non-filled apertures on the injector rail.	Seal non-filled apertures on the injector rail with a screw plug.
	The coarse or fine sieves are soiled.	Remove and clean the coarse and fine sieves, see Regular checks and cleaning [▶ page 65].
	Large containers with the opening pointing upwards may have been sorted into the device. This diverts water from the rinsing process.	Sort the containers in the device with their openings facing downwards.
	Strong foam generation: The instruments have been pre-cleaned in or placed in a foam-generating solution and have then been subject to insufficient rinsing.	Rinse the instruments thoroughly before reprocessing.
	Strong foam generation: Strong soiling of the filter disc in the universal adapter for transmission instruments.	Remove and replace the soiled filter disc. Clean the reusable filter screen.
Strong foam generation: Unsuitable process agents (rinse aid or cleaning agent) have been used.	Use only those process agents suitable for the device.	
451	The temperature difference between the two temperature sensors in the washing chamber is too great. The temperature sensors were not covered with water sufficiently. The upper rinse arm revolves too slowly.	Clean the upper rinse arm and check its ease of movement.
462 464	The water inflow is insufficient.	Check the water inflow of the device.
	The water inflow tap has not been opened completely.	Open the water inflow tap completely.
	The sieve in the cold water connection is blocked.	Remove and clean the sieve in the cold water connection.
	The cold water inlet hose is kinked.	Check the installation of the cold water inlet hose.
466	Insufficient DI water inflow.	Check the DI water supply.
	The DI water supply has been interrupted.	Check the DI water system for its correct function.
	The sieve in the DI water connection is blocked.	Remove and clean the sieve in the DI water connection.
	The DI water inlet hose is kinked.	Check the installation of the DI water inlet hose.

Event	Possible cause	Remedy
467	The water inflow is insufficient.	Check the water inflow of the device.
	The water inflow tap has not been opened completely.	Open the water inflow tap completely.
	The sieve in the cold water connection is blocked.	Remove and clean the sieve in the cold water connection.
	The cold water inlet hose is kinked.	Check the installation of the cold water inlet hose.
468	Insufficient DI water inflow.	Check the DI water supply.
	The DI water supply has been interrupted.	Check the DI water system for its correct function.
	The sieve in the DI water connection is blocked.	Remove and clean the sieve in the DI water connection.
	The DI water inlet hose is kinked.	Check the installation of the DI water inlet hose.
471	The door of the device was not locked correctly during the program start.	Switch the device off and then on again.
474	The HEPA filter is not recognised. A HEPA filter has not been inserted.	Insert the HEPA filter.
	The HEPA filter for the drying fan has not been inserted correctly.	Check whether the HEPA filter for the drying fan has been inserted correctly.
	The cover cap of the drying fan has not been locked correctly.	Close the cover cap of the drying fan correctly.
476	The requisite pressure for the drying has not been reached. The HEPA filter for the drying fan has not been inserted correctly.	Check whether the HEPA filter has been inserted correctly in the drying fan.
	The cover cap on the drying fan has not been locked correctly.	Close the cover cap of the drying fan correctly.
484	The rinse pressure in the washing chamber is too low. The water inflow is insufficient.	Check the water inflow of the device. Open the water inflow tap completely.
	The basis basket has been inserted incorrectly or not at all.	Insert the basis basket in the washing chamber correctly. The injector rail should be located on the right-hand side and dock with the blind cap on the fitting of the rear wall, see Inserting the basis basket [▶ page 23].
	Too many non-filled apertures on the injector rail.	Seal non-filled apertures on the injector rail with a screw plug.
	The coarse or fine sieves are soiled.	Remove and clean the coarse and fine sieves, see Regular checks and cleaning [▶ page 65].
	Large containers with the opening pointing upwards may have been sorted into the device. This diverts water from the rinsing process.	Sort the containers in the device with their openings facing downwards.
	Strong foam generation: the instruments have been pre-cleaned with a foam-generating solution and have then been subject to insufficient rinsing.	Rinse the instruments thoroughly before reprocessing.
	Strong foam generation: strong soiling of the filter disc in the universal adapter for transmission instruments.	Remove and replace the soiled filter disc. Clean the reusable filter screen.
	Strong foam generation: unsuitable process agents (rinse aid or cleaning agent) have been used.	NOTICE! Use only those process agents suitable for this device.
505	The salt storage has been exhausted. No new regeneration can be performed.	Fill regenerating salt, see Filling the regenerating salt [▶ page 23]. A program can be started if the salt has dissolved in the water. Do not start the program until the regenerating salt has been filled and the signal tone has sounded.

Event	Possible cause	Remedy
509	Liquid in the device floor trough.	CAUTION! Avoid contact with liquids in the floor trough; they can contain process agents. 1. Switch off the device. 2. Close the water inflow tap. 3. Contact the authorised customer services/stockist technician.
510	During a program run, the water level in the washing chamber was measured to be too high.	1. Press CONFIRM in the action bar on the display. 2. Close the door and start the program again.
512	The running program was interrupted by a power failure.	WARNING! Danger of contamination 1. Press CONFIRM to acknowledge the message. 2. Start the program again.
524	The door of the device is blocked and cannot be closed correctly.	Check the door area for blockages.
531	The emergency-opening on the door was actuated during a program run.	WARNING! Danger of contamination 1. Press CONFIRM to acknowledge the message. 2. Close and lock the door correctly. 3. Start the program again.
535	The fine sieve has been fitted incorrectly.	Insert the fine sieve correctly. The arrow on the fine sieve must point towards the left-hand corner of the washing chamber.
536	The upper / lower rinse arm is mechanically blocked.	Check the freedom of motion of the upper / lower rinse arm.
537	The impulse nozzle of the upper / lower rinse arm is blocked.	Remove and clean the upper / lower rinse arm.
538		Insert the basis basket correctly. The injector rail must dock on to the connection fitting.
539		Remove and clean the upper / lower rinse arm. Clean the sliding disc with a cloth.
539		Check the water inflow to the device: 1. Remove and clean the sieve in the cold water connection. 2. Check the installation of the inlet hose. 3. Open the water inflow tap completely.
546	The cartridge of the MELAdem 53/53 C was not vented correctly. A sudden flow of water causes incorrect readings for a short time.	1. Remove the air from the cartridge of the MELAdem 53/53 C (see "Commissioning" in the user manual of the water treatment unit). 2. Start the program again.
548	The conductivity of the DI water is insufficient (greater than 60 µS/cm). The MELAdem 53/53 C cartridge is exhausted.	Replace the MELAdem 53/53 C cartridge.
	The DI water supply is of insufficient quality.	Check the DI water supply.
571	The program cannot be started as brine is still in the water softening unit or washing chamber. Only the "Regeneration" program may be started.	Start the "Regeneration" program.
583	The water inflow was interrupted during the active program.	1. Open the water inflow tap completely. 2. Start the program again. The water inflow must be ensured during the entire duration of the active program.

Event	Possible cause	Remedy
620	Strong foam generation in the washing chamber. The instruments are pre-cleaned or placed in a foam-generating solution.	Load the instruments into the MELAtherm without pre-cleaning or rinse them thoroughly after placing in a solution.
	Unsuitable process agents (rinse aid or cleaning agent) have been used.	NOTICE! Use only those process agents suitable for this device.
	The metering concentration has been set incorrectly.	Check the settings of the metering concentration and if necessary, arrange for correction by an authorised customer service or a stockist technician.
	Strong soiling of the filters in the transmission instrument adapter.	Clean or renew the filters in regular intervals.
624	The collection tank is not pumped out.	<ol style="list-style-type: none"> 1. Switch the device off and then on again. 2. Start the program again.
626	The temperature during pre-cleaning is too high.	Check the water supply to the device.
632	The coarse or fine sieves are soiled.	<ol style="list-style-type: none"> 1. Remove and clean the coarse and fine sieves, see Regular checks and cleaning [▶ page 65]. 2. Switch the device off and then on again. 3. Start the program again.
653	The water inflow was interrupted during the active program.	<ol style="list-style-type: none"> 1. Open the water inflow tap completely. 2. Start the program again. <p>The water inflow must be secured during the entire duration of the active program.</p>
660 661	The power supply for the <u>DTA</u> device version is insufficient.	<ol style="list-style-type: none"> 1. Check whether the power plug has been inserted correctly in the socket. 2. Check the fuses in the sub-distribution.
662	The upper rinse arm is soiled.	Remove the upper rinse arm and clean the nozzles, see Regular checks and cleaning [▶ page 65].
669	The coarse or fine sieves are strongly soiled.	<ol style="list-style-type: none"> 1. Remove and clean the coarse and fine sieves, see Regular checks and cleaning [▶ page 65]. 2. Switch the device off and then on again. 3. Start the program again.
670	The water inflow was interrupted during the active program.	<ol style="list-style-type: none"> 1. Open the water inflow tap completely. 2. Start the program again. <p>The water inflow must be ensured during the entire duration of the active program.</p>
672	Insufficient conductivity ($\geq 25 \mu\text{S}/\text{cm}$) was measured in the washing chamber during disinfection in the Ophthalmic-Program. This could be caused by carry-over of process agents, regenerating salt or deposits. The program successfully completed despite the warning.	<ol style="list-style-type: none"> 1. Close the screw cap of the salt container correctly. 2. Setup the containers in the device with their openings facing downwards. 3. Check the hollow bodies before reprocessing for their free passage and correct position. 4. Clean the filter screen in the instrument connection equipment. 5. Remove and clean the coarse and fine sieves, see Regular checks and cleaning [▶ page 65]. 6. Insert the non-return valve in the pump sump correctly, see Cleaning on demand [▶ page 67]. 7. Check for foreign bodies in the non-return valve.
673	The Ophthalmic-Program does not start. A DI connection has not been set in the Settings menu.	<ol style="list-style-type: none"> 1. Connect the DI water. 2. Working in the display, select the Settings > DI water menu and set the parameter to yes.

Event	Possible cause	Remedy
675	Water is in the pump sump after pumping out. The coarse or fine sieves are soiled.	Remove and clean the coarse and fine sieves, see Regular checks and cleaning [▶ page 65].
	The non-return valve in the pump sump is missing or has been fitted incorrectly.	Insert the non-return valve in the pump sump correctly.
	The non-return valve is blocked by foreign bodies.	Check whether foreign bodies are in the non-return valve, see Cleaning on demand [▶ page 67].

13 Technical data

MELAtherm 10 Evolution DTA/DTB device dimensions

Device types	Semi-integrated unit	Free standing	Top-frame device
Device dimensions (H x W x D) ²⁾	81.8 x 59.8 x 68.1 cm	83.6 x 59.8 x 68.1 cm	124 x 59.8 x 68.1 cm
Empty weight	88 kg	94 kg	115 kg
Operating weight	122 kg	128 kg	191 kg

Device types	MELAtherm 10 Evolution DTA	MELAtherm 10 Evolution DTB
Washing chamber (H x W x D)	29 x 45.5 x 42.3 cm	
Washing chamber volume	84 l	
Electrical connection		
Power supply	3N AC 380-415 V, 50 Hz	AC 220-240 V, 50 Hz
Max. voltage range	360-440 V	207-253 V
Electrical power	10.3 kW	3.4 kW
Building fuses	3x 16 A, separate power circuit with Type B 16 A fuse, RCD switch with 30 mA	1x 16 A, separate power circuit with Type B 16 A fuse, RCD switch with 30 mA
Overvoltage category	Transient overvoltage up to the values of overvoltage category II	
Length of the power cable	2 m	
Degree of air pollution (in accordance with EN 61010-1)	Category 2	
Ambient conditions		
Installation location	Interior of a building	
Max. noise emission (Drying)	73 dB(A)	
Noise emission median value	66.2 dB(A)	
Waste heat (with max. solid load)	0.98 kWh (3.5 MJ)	
Ambient temperature	5-40 °C (recommended max. 25 °C)	
Air pressure	750-1060 mbar	
Relative humidity	max. 80 % at temperatures up to 31 °C, max. 50 % at 40 °C (decreasing in a linear fashion)	
Degree of protection (in accordance with IEC 60529)	IP20	
Max. altitude	1500 m (it may be necessary to reduce the disinfection temperature depending on the installation height; see the technical manual)	
Cold water		
Connection cold water / DI water	3/4" internal thread (for the connection to a standard 3/4" connection with external thread)	
Cold water quality	Comply with the specifications of the Drinking Water Ordinance (TrinkwV) or the applicable local specifications	
DI water quality (max. permissible conductivity)	from 15 µS/cm warning, from 60 µS/cm malfunction, Ophthalmo-Program: from 25 µS/cm malfunction	
Min. flow pressure	1.5 bar at 8 l/min Netherlands: 2 bar at 8 l/min	
Recommended flow pressure	2.5 bar at 8 l/min Netherlands: 3 bar at 8 l/min	
Max. water pressure (static)	10 bar	
Cold water temperature	1-26 °C	

²⁾ Appropriate for a 60 cm deep working surface

Device types	MELAtherm 10 Evolution DTA	MELAtherm 10 Evolution DTB
Wastewater		
Wastewater connection	DN21	
Max. wastewater temperature	93 °C (< 1 min, approx. 7 l)	
Amount of wastewater per hour	approx. 38 l (in short intervals)	
Capacity of drain pump	max. 40 l/min (volume in outlet hose)	
Length of the inlet and outlet hose	each 1.80 m (extension optionally available)	

14 Accessories and spare parts

You can obtain the specified articles together with an overview of further accessories from your stockist. Information regarding the instrument reprocessing accessories can be found in the current MELAG price list.

	Article	Art. no.
Optionally available	Floor unit (H x W x D) 40 cm x 59.8 cm x 59.8 cm	ME11021
	Stainless steel cover plate (H x W x D) 1.8 cm x 59.8 cm x 59.8 cm	ME65310
Water treatment	MELAdem 53	ME01038
	MELAdem 53 C	ME01036
Documentation	MELAflash CF card	ME01043
	MELAflash card reader	ME01048
	MELAprint 44 log printer	ME01144
	Ethernet adapter for MELAprint 42/44	ME40295
Process agents	Rinse aid storage container (1 l)	ME60910
Others	Pre-filter drying fan	ME68130
	HEPA filter	ME51240
	Feed funnel for salt container	ME68200

15 Documentation and approval

Video tutorial

See also "Batch Approval".



P*)	D**)	B***)	Program / load	Process successful?	Process approval?	Instrument approval?	Remarks	Signature
				yes	yes	yes		
			reprocessed on:	no	no	no		
				--	--	partially		
					yes	yes	yes	
			reprocessed on:	no	no	no		
				--	--	partially		
					yes	yes	yes	
			reprocessed on:	no	no	no		
				--	--	partially		
					yes	yes	yes	
			reprocessed on:	no	no	no		
				--	--	partially		
					yes	yes	yes	
			reprocessed on:	no	no	no		
				--	--	partially		
					yes	yes	yes	
			reprocessed on:	no	no	no		
				--	--	partially		
					yes	yes	yes	
			reprocessed on:	no	no	no		
				--	--	partially		
					yes	yes	yes	
			reprocessed on:	no	no	no		
				--	--	partially		
					yes	yes	yes	
			reprocessed on:	no	no	no		
				--	--	partially		

*) personal number | **) device number | ***) batch number

Glossary

A0-value

The A0 value represents a standard for the elimination of microorganisms and the deactivation of viruses in the disinfection procedure with damp heat. The A0 value depends on temperature and time.

AKI

Abbreviation for "Arbeitskreis Instrumentenaufbereitung" (Instrument Reprocessing Working Group)

Authorised technician

The term "authorised technician" refers to an employee of a customer service provider or stockist who has been trained and authorised by MELAG to perform maintenance and installation work on MELAG devices. Only they may carry out this work.

Batch

The batch is the composition of items which has been subject to the same reprocessing procedure.

BfArM

"Bundesinstitut für Arzneimittel und Medizinprodukte" (Federal Institute for Drugs and Medical Devices) in Germany.

CF card

The CF card is a memory medium for digital data; Compact Flash is an official standard, i.e. these memory cards can be used in every device fitted with the corresponding slot. The CF card can be read by every device that supports the standard and where necessary, written on.

Cleaning agent

A cleaning agent is a substance or mixture of chemical substances which supports the cleaning of medical devices.

Competent personnel

Trained personnel in accordance with national specifications for the respective area of application (dentistry, medicine, podiatry, veterinary medicine, cosmetics, piercing, tattoo) with the following contents: knowledge of instruments, hygiene and microbiology, risk assessment and classification of medical devices and instrument reprocessing.

Conductivity

is the ability of a conductive chemical substance or mixture of substances to conduct or transfer energy or other substances or particles in space.

Demineralised water

Water without the minerals usually found in normal spring or tap water; is produced through ion exchange of normal tap water. It is used here as feed water.

DGKH

Abbreviation for "Deutsche Gesellschaft für Krankenhaushygiene e.V." (Commission for Hospital Hygiene and Infection Prevention)

DGSV

Abbreviation for "Deutsche Gesellschaft für Sterilgutverordnung" (German Association for the Sterilized Equipment Ordinance). The DGSV training centres are specified in DIN 58946, part 6 as "Requirements of personnel".

DI water

Demineralised water (DI water) is water (H₂O) without the salts found in normal spring and tap water, which are dissolved as anions and cations.

Effectiveness range

The effectiveness of disinfection measures and agents against pathogens is divided by the Robert Koch Institute into microbiological effect ranges. The effectiveness ranges are identified by the letters A, B, C and D. [see also RKI]

EN ISO 15883

Standard - Washer-disinfectors

EN ISO 17664

Standard - Reprocessing of healthcare products - Information to be provided by the medical device manufacturer for the reprocessing of medical devices

HEPA filter

The HEPA filter is a filter group H filter element (particulate material filter), in accordance with EN 1822-1. This group is sub-divided into two classes, H13 and H14. Filter elements are classified in accordance with their filter capacity. The HEPA filter is used in medical environments to purify the air microbiologically from suspended particles.

KRINKO

Abbreviation for "Kommission für Krankenhaushygiene und Infektionsprävention" (Commission for Hospital Hygiene and Infection Prevention) at the Robert Koch Institute in Germany.

Load

The load refers to all possible instruments such as basins, glassware and other objects which can be reprocessed in a washer-disinfector.

Neutraliser

The neutraliser is a citric acid-based (e.g. MEtherm 55) or phosphoric acid-based (e.g. MEtherm 56) acidic medium which can be added to the subsequent rinse water in automatic reprocessing after an alkaline cleaning in order to neutralise the alkalinity in order to assist in the removal of the cleaning agent.

pH Value

The pH value is a measure of the strength of the acid or alkali effect of a watery solution.

Process agent

A process agent is a composition of chemical compounds for designed for reprocessing purposes e.g. of medical instruments. Process agents used in a washer-disinfector consist of a cleaning agent, neutraliser and rinse aid.

Qualified electrician

Person with suitable technical training, knowledge and experience so that he or she can recognise and avoid hazards that can be caused by electricity [see IEC 60050 or for Germany VDE 0105-100].

Reprocessing

Reprocessing is a measure to prepare a new or used healthcare device for its intended purpose. Reprocessing includes cleaning, disinfection, sterilization and similar procedures.

Rinse aid

The rinse aid is a mixture of chemical substances which can be added to the last subsequent rinse water used in an automatic reprocessing process to achieve better and quicker drying. The active agents contained in the subsequent rinse medium reduce the surface tension of the subsequent rinse water, thereby minimizing the adherent residual moisture.

RKI

Abbreviation for "Robert Koch Institute". It is one of the most important bodies for the safeguarding of public health in Germany.



MELAG Medizintechnik GmbH & Co. KG

Geneststraße 6-10
10829 Berlin
Germany

Email: info@melag.com
Web: www.melag.com

Original instructions

Responsible for content: MELAG Medizintechnik GmbH & Co. KG
We reserve the right to technical alterations

Your stockist